

ANTES DE COMENZAR, RECOPILE TODO EL MATERIAL DE APOYO PARA EL MONTAJE: Instrucciones de montaje / ilustraciones paso a paso / planos y plantillas impresos a escala.

PREPARACIÓN DEL MATERIAL: Para poder identificar correctamente las piezas precortadas, antes de extraerlas de las planchas de madera, marque en ellas la misma numeración que aparece en la hoja "IP" (identificación de piezas), incluida en las instrucciones.

INICIO DEL MONTAJE: Con la ayuda de un cúter y procurando no colocar los dedos en la línea de corte, desprenda las piezas de las planchas eliminando los pequeños nervios que las sujetan. Seguidamente lije con suavidad las piezas con papel de lija de grano fino, para eliminar el repelo de las mismas. El orden numérico del paso a paso indica el orden de elaboración y colocación de las piezas. Es importante comprobar el ajuste de las piezas antes de pegarlas definitivamente.

LISTONES Y VARILLAS: Los modelos incorporan varios tipos de listones y varillas para elaborar las diferentes piezas. La lista de piezas proporciona información sobre el tipo de material y medidas. En algunos casos es conveniente ajustar las medidas sobre el propio modelo, conforme avanzamos en el montaje. De esta manera se consigue un mejor ajuste.

PEGAMENTOS RECOMENDADOS: Cola blanca o de carpintero. Para las uniones de piezas de madera y de todas aquellas piezas que no ofrezcan resistencia.

Pegamento rápido. Para piezas que sean difíciles de sostener y que necesiten un secado casi instantáneo.

Cola de contacto o de zapatero. Para todas aquellas piezas que se forren con chapas finas de madera o metal. En todos los casos, lea siempre las instrucciones de uso del fabricante.

SERVICIO DE ATENCIÓN AL CLIENTE: Para cualquier duda o información sobre el montaje de nuestros productos, puede contactar con nuestro Servicio Técnico en la dirección:

www.occre.com. Le atenderemos con mucho gusto.

BEFORE STARTING, MAKE SURE YOU HAVE ALL THE SUPPORT MATERIAL FOR ASSEMBLING THE MODEL:

Assembly Instructions / Step by step pictures / Plans and templates printed to scale.

PREPARING THE MATERIAL: In order to correctly identify the precut parts, before removing them from the wooden sheets, mark on them the same numbers that appear on the "IP"

(Part Identification) Sheet included with the instructions.

STARTING THE ASSEMBLY: Using a cutter, and making sure you do not put your fingers along the cutting line, remove the parts from the wooden sheets, eliminating the small sprues that hold them in place. In continuation smoothly sand down the parts, using fine grain sandpaper, to eliminate the pickup of the parts. The numerical order indicates the order in which the different parts must be made up and fitted.

STRIPS AND RODS: These models incorporate a variety of different types of strips and rods with which to make up the different parts of the kit. The list of parts proportions information on the type of material and measurements. In some cases it is advisable to adjust the measurements on the basis of the model itself, as assembly progresses. In this way you will achieve a better fit.

RECOMMENDED GLUES: White, or carpenter's glue: For joining pieces of wood together. Mainly used for gluing together the skeleton. Quick-drying glue. For parts that are difficult to hold in their final position and which need to set instantly. Recommended for fitting small parts. Contact or cobbler's glue. For gluing into place the parts that are covered with fine wood veneer to set instantly. In all cases, always follow the manufacturer's recommendations.

CUSTOMER ATTENTION SERVICE: In the case of whatsoever doubt or further information that you may require regarding the assembly of our products, please contact our Technical Service online at the address: www.occre.com. We will be delighted to attend to you.

AVANT DE COMMENCER, VÉRIFIEZ TOUT LE MATÉRIEL DE SOUTIEN POUR LE MONTAGE:

PRÉPARATION DU MATÉRIEL: Pour pouvoir identifier correctement les pièces prédécoupées, avant de les extraire des planches de bois, inscrivez sur elles la même numérotation qui apparaît sur la page « IP » (identification des pièces) comprise dans les instructions.

DÉBUT DU MONTAGE: À l'aide d'un cutter, et en essayant de ne pas poser les doigts sur la ligne de découpe, séparez les pièces des planches en éliminant les petits nerfs qui les retiennent. Puis poncez doucement les pièces à l'aide d'un papier de verre à grain fin, pour éliminer le contrefil. L'ordre numérique des étapes photographiques et des plans indique l'ordre d'élaboration et d'installation des pièces.

LISTEAUX ET BAGUETTES: Les modèles intègrent plusieurs types de listeaux et de baguettes destinés à confectionner les différentes pièces. La liste des pièces indique le type de matériau et les dimensions des pièces. Il est parfois recommandé d'ajuster les mesures sur le modèle lui-même, au fur et à mesure que nous avançons dans le montage. De cette manière, on obtient un meilleur réglage.

COLLES RECOMMANDÉES: Colle blanche ou de menuisier: Pour les unions de pièces en bois et de toutes les pièces qui n'offrent pas de résistance. Colle à séchage rapide: Pour les pièces qui sont difficiles à maintenir dans leur position et qui requièrent un séchage pratiquement instantané. Colle de contact ou de cordonnier: Pour toutes les pièces qui sont recouvertes de fines plaques de bois ou de métal. Dans tous les cas, lisez toujours les instructions d'utilisation du fabricant.

SERVICE CLIENT: Pour toute question ou information concernant le montage de nos produits, vous pouvez contacter notre Service Technique à l'adresse suivante: www.occre.com.

Nous répondrons avec plaisir à vos questions.

PRIMA D'INIZIARE, RIUNIRE TUTTO IL MATERIALE D'APPOGGIO PER IL MONTAGGIO: Istruzioni di montaggio, immagini passo per passo, planimetrie e modelli stampati in scala.

PREPARAZIONE DEL MATERIALE: Per poter identificare in maniera corretta i pezzi che sono stati ritagliati, prima di estrarli dai blister di legno occorre segnarli con la stessa numerazione che è indicata nella pagina "IP" (Identificazione pezzi) che si trova nelle istruzioni.

INIZIO DEL MONTAGGIO: Con l'aiuto di un cutter, ed evitando di collocare le dita lungo la linea di taglio, separare i pezzi dai blister eliminando i piccoli nervi che li mantengono attaccati.

In seguito, scartavetrare con delicatezza i pezzi, utilizzando una carta vetrata a grana fine, onde eliminare le sbavature degli stess. L'ordine numerico del passo per passo indica l'ordine d'elaborazione e di collocazione dei pezzi. È importante verificare che questi combacino bene, prima d'incollarli definitivamente.

ASTE E BACCHETTE: I modelli sono dotati di vari tipi di aste e bacchette per formare i diversi pezzi. L'elenco dei pezzi offre informazioni sul tipo di materiale e sulle misure. In alcuni casi è conveniente modificarne le misure quando sono sul modello, man mano che si avanza nel montaggio. In questo modo si potrà ottenere che combacino meglio.

COLLE RACCOMANDATE: Colla bianca o da falegname: Per unire tra loro i pezzi in legno e tutti quei pezzi che non presentino resistenza. Colla rapida: Per i pezzi difficili da sostenere e per i quali sia necessaria un'asciugatura quasi istantanea. Colla a contatto o da calzolaio: Per tutti quei pezzi che vengono rivestiti con fine lastre di legno o di metallo. In ogni caso, leggere sempre le istruzioni d'uso del produttore.

SERVIZIO ASSISTENZA CLIENTE: Per qualsiasi dubbio o informazione sul montaggio dei nostri prodotti, contattare il nostro Servizio Tecnico al seguente indirizzo: www.occre.com.

Seremo lieti di potervi aiutare.

BEVOR SIE MIT DEM ZUSAMMENBAU BEGINNEN, LEGEN SIE SICH BITTE ALLE HILFSMATERIALIEN FÜR DIE MONTAGE BEREIT:

Bastelanleitung / Maßstabgerechte Skizzen und Schablonen / Skizzen und Vorlagen.

VORBEREITUNG DER MATERIALIEN: Damit die einzelnen Bauteile korrekt zugeordnet werden können, empfehlen wir, auf den Holzplättchen vor dem Herausnehmen mit einem Bleistift die Nummer auf dem Blatt IP (Identifikation Teile) zu markieren.

BEGINN DES ZUSAMMENBAUS: Die Teile mit einem Schneidwerkzeug (Cutter) herauslösen und die kleinen Befestigungsenden entfernen. Dabei darauf achten, die Finger nicht zu verletzen. Danach die Teile vorsichtig mit feinem Schmirgelpapier säubern, um ausgefranste Ränder zu entfernen. Die Nummernfolge der Schritte auf Fotos und Skizzen gibt an, in welcher Reihenfolge die Teile zusammengebaut werden.

LEISTEN UND STÄBE: Die Modelle enthalten mehrere Arten von Leisten und Stäben, aus denen die einzelnen Teile des Bausatzes geformt werden. In einigen Fällen kann es angebracht sein, die Maße im Zuge des Zusammenbaus entsprechend dem Modell anzupassen. Auf diese Weise wird eine bessere Passform erricht.

EMPFOHLENE KLEBSTOFFE: Weißleim (Tischlerleim): Zum Kleben von Strukturteilen und allen nachgiebigen Teilen. Sekundenkleber: Für schwer zu haltende Teile, die schnell verklebt werden müssen. Kontaktkleber (Schusterleim): Für alle Teile, die mit dünnen Holz- oder Metallstücken zum Beplanken oder Verkleiden beklebt werden. Bitte beachten Sie stets die Hinweise des Herstellers.

UNSER KUNDENDIENST: Bei Fragen zum Aufbau unserer Modelle steht Ihnen unser Kundendienst zur Verfügung. Sie erreichen uns online unter: www.occre.com.

Wir stehen Ihnen gern mit Rat und Tipps zur Verfügung.

A. Utilice una superficie plana y estable para pegar las piezas A1 y A2, y refuerce su unión con las piezas A3 y A4. Siguiendo el orden alfanumérico inserte y pegue las piezas indicadas en las figuras. Antes de encolar las cuadernas, verifique que encajan correctamente en su posición haciendo "tope" en los encajes correspondientes de la falsa quilla. Es importante que las cuadernas queden completamente perpendiculares a la falsa quilla para que posteriormente encajen bien las cubiertas. Para esta operación utilice como adhesivo cola blanca, (Ref.19200).

B. Corte las tiras de forro y destaque sus cantos con un lápiz. Comience a forrar la cubierta ajustando la primera chapa a la línea de lápiz que le indica la imagen. Pegue las chapas muy juntas para que no se noten las uniones. Utilice como adhesivo cola de contacto, (cola de zapatero). Frote las chapas contra la cubierta para que se adhieran con firmeza. Después, corte los sobrantes de las chapas con un cúter. Lije la cubierta hasta dejar su superficie fina y homogénea. Después, elimine el polvo resultante del lijado y aplique un par de capas de barniz satinado, (Ref.19209), lijando entre una y otra. Forre todas las cubiertas como le indican las imágenes. Después, líjelas y barnícelas con barniz, (Ref.19209).

C y D. Construya las estructuras siguiendo el orden alfanumérico de las imágenes. Para esta operación utilice cola blanca. Ajuste y pegue las cubiertas sobre las estructuras. Utilice para las estructuras masilla tapa-grietas, (Ref.19143). Después de lijarlas, aplíqueles imprimación, (Ref.19142).

E. Coloque el casco boca abajo y comience a lijar empezando desde proa y avanzando hacia popa. Debe desbastar las aristas de las cuadernas pero sin deformar su forma original. El lijado del casco ha de quedar simétrico, es decir, que el lateral derecho ha de quedar igual que el izquierdo. Para la zona media del casco, utilice un taco lijador con mayor superficie. El lijado debe ser progresivo y suave. Compruebe con un listón, que el lijado es correcto. Para ello, debe deslizar el listón, sobre las cuadernas, para ver como se ajusta a su forma.

F a H. Comience el forrado del casco con los listones F2. Si los listones estuvieran muy secos y se le rompen al curvarlos, sumérjalos en agua unos veinte minutos. Con esta operación, recuperarán flexibilidad. Después, séquelos con un paño. Debe pegar el primer listón desde la proa hasta la cuaderna 7, con cola blanca, (Ref.19200). Después, deberá clavarlo con puntas A. Pegue otro listón F2 para dar continuidad al primero hasta la parte trasera del casco. Los demás listones del forro debe pegarlos a las cuadernas y entre sí, con cola blanca y fijarlos con puntas. Continúe pegando listones desde proa hasta popa para forrar el casco entero. Deberá cortar a medida y ajustar las piezas para que encajen en los huecos. Si en algún punto le ha quedado algún listón suelto, puede aplicar pegamento de secado rápido. Si le ha quedado algún listón más hundido, pegue otro encima y después, líjelo. Lime las cabezas de las puntas con una lima plana hasta que queden enrasadas con el forro. Diluya un poco de cola blanca con agua para que pueda aplicarla ligeramente y se filtre entre las juntas de los listones. Reserve el casco hasta que la cola se seque. Con esta operación se unificará el forro del casco ganando así consistencia. Después, lije todo el casco. Debe quedar suave y sin desniveles.

i y J. Aplique cola de contacto, (cola de zapatero), a la zona del casco que le indican las imágenes. Encole y pegue las tiras de forro i1. Debe combinar tiras i1 para completar la longitud total del casco. Corte a medida las tiras de forro dependiendo de la necesidad. Frote las tiras de forro para que se adhieran con firmeza.

K. Aplique masilla tapa-grietas, (Ref.19143), a todo el casco y cuando se haya secado líjelo, debe quedar fino al tacto. Repita la misma operación hasta obtener un acabado fino. Aplique imprimación, (Ref.19142), a todo el casco y vuelva a lijar. Utilice cinta de carroceros para enmascarar las zonas de la estructura del casco. Pinte la parte inferior del casco con pintura de color verde oscuro, (Ref.19315). Para esta operación puede utilizar pincel o bien pintar a spray o aerógrafo. Completa el casco con los colores blanco, (Ref.19300), ocre claro, (Ref.19387), y negro, (Ref.19301).

L. Utilice las plantillas PL-01 para medir e identificar las piezas y su posición en el casco. Utilice un punzón para marcar el centro de cada orificio en el casco. Después, realice todos los orificios. Proceda de la misma manera en el otro lateral del casco. Inserte y pegue una pieza C10 en cada orificio.

M a Z. Construya las estructuras siguiendo el orden alfanumérico de las imágenes. Vaya construyendo y decorando las piezas y añádalas al barco para completarlo. Utilice cinta de carroceros para aislar las estructuras y poder decorarlas con precisión. Construya y decore las barcas utilizando como guía de color las imágenes.

ARBOLADURA

Para elaborar los mástiles, el primer paso a seguir será cortar las varillas según las medidas que indica la lista de piezas, o bien tomarlas directamente de los planos que están impresos a escala 1/1.

Todos los mástiles y vergas tienen cierta conicidad que se deberá realizar.

Para realizar la conicidad a los mástiles, lije las varillas, (con un lijador), aumentando el desgaste de ésta a medida que se acerca al extremo donde se quiere disminuir el diámetro. Haga rodar la varilla para que el desgaste sea igual por todo el contorno hasta conseguir llegar al diámetro que indica el plano. Para elaborar la conicidad de las vergas, realice las mismas operaciones, pero esta vez a ambos extremos de la varilla. Deberá teñir o pintar las varillas en función del modelo que esté construyendo.

Para realizar correctamente los mástiles de este modelo se deberá tener en cuenta:

- Los planos
- Las fotos de detalle de los mástiles
- Las medidas y descripción de materiales de la lista de piezas
- Las hojas "IP" de identificación de piezas
- La plantilla PL-01

Los mástiles se deberán barnizar y algunas de las piezas que los componen se deberán pintar. Véanse las fotos generales de detalle de los mástiles. Una vez montados y barnizados, deberán colocarles los aparejos, (estrobos, cuadernales, cáncamos, motones, etc.), y fijarlos al barco. Los mástiles se deben introducir hasta hacer tope en los encajes de la falsa quilla.

JARCIA

Para elaborar la jarcia de este barco, siga el orden alfabético de las figuras impresas de los planos, que indican el orden de colocación: de hilos, vigotas, motones, velas, etc, destacados en color rojo. La lista de piezas le orientara sobre el tipo de materiales y medidas a utilizar.

Para simular el envejecido de las velas, se les puede dar un baño con infusión de té, sin hacerlas hervir, y dejarlas secar bien arrugadas. Se colocaran sin planchar para que tengan cuerpo.

A: On a flat, stable surface glue pieces A1 and A2, and reinforce the joint with pieces A3 and A4. Following the alphanumeric order, insert and glue the parts as shown in the figures. Before gluing the frames together, check that they fit correctly into position by "butting" them into the corresponding sockets in the false keel. It is important that the frames are fitted completely perpendicular to the false keel so that the decks fit properly afterwards. Use white glue (Ref.19200).

B: Cut the planks and highlight their edges with a pencil. Start planking the deck by fitting the first plank to the pencil line shown in the picture. Glue the planks tightly together so that the joints are not visible. Use contact glue (cobbler's glue) as adhesive. Press the sheets against the deck so that they adhere firmly. Then cut off any excess using a box cutter. Sand the deck to a fine, even surface. Afterwards, remove the dust from sanding and apply a couple of coats of satin varnish, (Ref.19209), sanding between coats. Cover all decks as shown in the pictures, then sand and varnish, (Ref.19209).

C-D: Build the structures following the alphanumeric order of the images. Use white glue. Fit and glue the covers onto the structures. Use crack-covering putty (Ref.19143) for the structures. After sanding, apply primer, (Ref.19142).

E: Place the hull upside down and begin sanding starting from the bow and working towards the stern. You must rough the edges of the frames but without deforming their original shape. The sanding of the hull must be symmetrical, that is, the right side must be the same as the left. For the middle of the hull, use a sanding block with a larger surface. Sanding must be progressive and smooth. Check with a strip that the sanding is correct. To do this, you must slide the slat, over the frames, to see how it adjusts to its shape.

F-G-H: Start the hull planking using the F2 pieces. If the planks are too dry and break when bent, soak them in water for about 20 minutes. This will make them flexible. Afterwards, dry them with a cloth. You must glue the first batten from the bow to frame 7, using white glue, (Ref.19200). Then fasten it using A pins. Glue another F2 batten to continue the first one to the stern of the hull. The remaining planking must be glued to the frames and to each other with white glue and pinned. Continue gluing planking from bow to stern to cover the entire hull. You will need to cut the pieces to size and adjust them to fit the holes. If there are any loose planks at any point, you can apply quick-drying glue. If any of the planks are recessed, glue another one on top and then sand them. File the pinheads with a flat file until they are flush with the planking. Dilute a little white glue with water so that you can apply it gently and it seeps between the joints of the planks. Set the hull aside until the glue dries. This will bind the hull lining and make it stronger. Then sand the entire hull. It should be smooth and even.

I-J: Apply contact glue (cobbler's glue) to the area of the hull shown in the pictures. Glue the planking strips i1. You must join i1 strips to complete the total length of the hull. Cut the planking to size according to need. Press the planks so that they adhere firmly.

K: Apply crack-cover putty, (Ref.19143) to the entire hull and when dry sand it; it should be smooth to the touch. Repeat the same operation until a fine finish is obtained. Apply primer, (Ref.19142) to the entire hull and sand again. Use masking tape to mask areas of the hull's frame. Paint the lower part of the hull with dark green paint, (Ref.19315). You can use a brush, spray or airbrush for this operation. Complete the hull with the colors white, (Ref.19300), light ochre, (Ref.19387), and black (Ref.19301).

L: Use template PL-01 to identify the pieces and their position on the hull. Use an awl to mark the centre of each hole on the hull. Then drill all the holes. Proceed in the same way on the other side of the hull. Insert and glue an C10 piece into each hole.

M to Z: Build the structures following the alphanumeric order of the images. Go building and decorating the pieces and add them to the ship to complete it. Use masking tape to insulate structures so you can decorate them precisely. Build and decorate the boats using the images as a color guide.

MASTS AND SPARS

In order to make up the masts the first step is to cut the rods to size, as indicated in the parts list, or by taking measurements directly from the plans, which are printed in 1/1 scale.

All of the masts and spars have to have a certain conical shape, which they will have to be given.

In order to achieve this conical shape for the masts, sand down the rod (using a sander), increasing the amount of sanding down as you get closer to the end at which you want to decrease the diameter. Turn the rod so that you sand it down evenly on all sides, until achieving the diameter indicated in the plan.

To achieve this conical shape for the spars carry out the above operations but in this case evenly reducing the diameter at both ends of the rod.

The rods will have to be stained or painted, depending on the model that you are building.

To correctly make up the mast for this model you must take into account:

- The plans
- The close-up photos of the masts and spars
- The measurements and material descriptions of the parts list
- The "PI" parts identification sheets
- Template PL-01

The masts and spars need to be varnished, while some of the parts that make them up are meant to be painted. Examine the general and close-up photos of the masts

Once the mast and spars has been assembled and varnished fix the tackle (slings, blocks, eyebolts, clump blocks, etc.) into place on the ship. The masts will have to be fully inserted into the sockets prepared to receive them in the false keel.

SAILS AND RIGGING

In order to make up the running gear for this ship follow the alphabetic order of the images printed on the plans, indicating the order for fitting the (ropes, clump blocks, blocks, sails, etc.) highlighted in red. In combination with the parts list this will serve as a guide with regard to the type of material to be used and the measurements.

A method for simulating the aging of the sails is to soak them in an infusion of tea, without boiling, and then leaving them to dry all wrinkled up. Fit them in place without ironing so that they will have a certain consistency.

A: Utilisez une surface plane et stable pour coller les pièces A1 et A2, et renforcez leur union à l'aide des pièces A3 et A4. En suivant l'ordre alphanumérique, insérez et collez les pièces indiquées sur les figures. Avant de coller les couples, vérifiez qu'ils s'adaptent correctement à leur emplacement et font office de « taquet » dans les emboîtements correspondants de la fausse quille. Il est important que les couples restent totalement perpendiculaires à la fausse quille afin que les ponts viennent s'emboîter correctement par la suite. Pour cette opération, utilisez de la colle blanche comme adhésif (Réf.19200).

B: Découpez les bandes de garniture et faites ressortir les champs à l'aide d'un crayon. Commencez par garnir le pont en ajustant la première planche sur la ligne de crayon comme indiqué sur l'image. Collez les planches très rapprochées afin que les unions restent invisibles. Utilisez la colle de contact (colle de cordonnier). Appuyez en lissant sur les planches contre le pont pour qu'elles adhèrent fermement. Puis coupez l'excédent des planches au cutter. Poncez le pont jusqu'à ce que la surface devienne fine et homogène. Puis éliminez la poussière du ponçage, et appliquez deux couches de vernis satiné (Réf.19209), en ponçant entre l'une et l'autre. Garnissez tous les ponts comme indiqué sur les images, puis poncez-les et vernissez-les avec du vernis (Réf.19209).

C-D: Construisez les structures en suivant l'ordre alphabétique des images. Pour cette opération, utilisez de la colle blanche. Ajustez et collez les ponts sur les structures. Utilisez du mastic bouche-fissures pour les structures (Réf.19143). Puis poncez-les, et appliquez de l'enduit (Réf.19142).

E: Placez la coque à l'envers et commencez à poncer à partir de la proue et en allant vers la poupe. Vous devez ébaucher les bords des cadres mais sans déformer leur forme d'origine. Le ponçage de la coque doit être symétrique, c'est-à-dire que le côté droit doit être le même que le gauche. Pour le milieu de la coque, utilisez un bloc de ponçage avec une plus grande surface. Le ponçage doit être progressif et lisse. Vérifiez avec une bande que le ponçage est correct. Pour ce faire, vous devez faire glisser la latte, sur les cadres, pour voir comment elle s'adapte à sa forme.

F-G-H: Commencez la garniture de la coque à l'aide des listeaux F2. Si les listeaux sont très secs, et qu'ils se cassent en les courbant, plongez-les dans l'eau environ vingt minutes. Grâce à cette opération, ils gagneront en souplesse. Puis, séchez-les à l'aide d'un chiffon. Collez le premier listeau de la proue vers le couple 7, avec de la colle blanche (Réf.19200). Puis, fixez-le à l'aide des pointes A. Collez un autre listeau F2 dans le prolongement du premier, jusqu'à la partie arrière de la coque. Les autres listeaux de la garniture seront collés aux couples et entre eux, avec de la colle blanche puis fixés à l'aide de pointes. Continuez à coller les listeaux de la proue à la poupe pour garnir l'ensemble de la coque. Découpez sur mesure et ajustez les pièces pour qu'elles s'adaptent aux cavités. Si quelque part un listeau n'est pas fixé, vous pouvez appliquer de la colle à séchage rapide. Si un des listeaux est enfoncé, collez-en un autre par-dessus, et poncez-le. Limez les têtes des pointes à l'aide d'une lime plate pour les niveler avec la garniture. Diluez un peu de colle blanche avec de l'eau afin de l'appliquer légèrement et qu'elle pénètre entre les listeaux. Ne touchez plus la coque jusqu'à ce que la colle soit sèche. Cette opération permettra d'unifier la garniture de la coque et de gagner en consistance. Puis poncez toute la coque. Elle doit être douce et régulière.

i-J: Appliquez de la colle de contact (colle de cordonnier), sur la zone de la coque comme indiqué sur les images. Encollez les bandes de garnitures i1 et collez-les. Combinez des bandes i1 pour compléter la longueur totale de la coque. Découpez sur mesure les bandes de garniture selon le besoin. Appuyez en lissant sur les bandes de garniture afin qu'elles adhèrent fermement.

K: Appliquez du mastic bouche-fissures (Réf.19143) sur toute la coque, et une fois sec, poncez-la pour la rendre fine au toucher. Renouvelez l'opération jusqu'à obtenir une finition fine. Appliquez de l'enduit, (Réf.19142) sur toute la coque et poncez à nouveau. Utilisez du ruban de carrossier pour masquer les zones de la structure de la coque. Peignez la partie inférieure de la coque avec de la peinture de couleur vert foncé (Réf.19315). Pour cette opération, vous pouvez utiliser un pinceau ou peindre à l'aide d'un spray ou d'un aérographe. Complétez la coque avec les couleurs blanc, (Réf.19300), couleur ocre clair, (Réf.19387), et noir, (Réf.19301).

L: Utilisez le patron PL-01 pour identifier les pièces et leur position sur la coque. Utilisez un poinçon pour marquer le centre de chaque orifice sur la coque. Puis, réalisez tous les orifices. Procédez de la même manière sur l'autre côté de la coque. Insérez et collez une pièce C10 dans chaque orifice.

M to Z. Construisez les structures en suivant l'ordre alphabétique des images. Construisez et décorez les pièces et ajoutez-les au navire pour le compléter. Utilisez du ruban adhésif pour isoler les structures afin de pouvoir les décorer avec précision. Construisez et décorez les bateaux en utilisant les images comme guide de couleurs.

MÂTURE

La première chose à faire pour confectionner les mâts est de couper les baguettes aux dimensions indiquées dans la liste des pièces ou de prendre ces mesures directement des plans qui sont imprimés à l'échelle 1/1.

Tous les mâts et les vergues possèdent une certaine conicité qui doit être travaillée.

Pour réaliser la conicité des mâts, poncer les baguettes (avec une ponceuse) en augmentant le dégrossissage au fur et à mesure qu'on s'approche de l'extrémité où l'on souhaite diminuer le diamètre. Faire rouler la baguette afin que l'usure soit égale sur tout le contour jusqu'à ce qu'on obtienne le diamètre indiqué sur le plan.

Effectuer les mêmes opérations pour réaliser la conicité des vergues mais, dans ce cas, aux deux extrémités de la baguette.

Il faudra teinter ou peindre les baguettes en fonction de la maquette qui sera construite.

Pour réaliser correctement les mâts de cette maquette, il faudra tenir compte :

- Des plans
- Des photos de détail des mâts.
- Des dimensions et de la description des matériaux de la liste des pièces.
- Des feuilles « IP » d'identification des pièces.
- Le patron PL-01

Les mâts devront être vernis et certaines des pièces qui les composent devront être peintes. Voir les photos générales de détail des mâts.

Lorsque les mâts seront montés et vernis, on placera leurs appareils (estropes, moufles, pitons, poulies, etc.) et on les attachera au bateau. Les mâts doivent être introduits de sorte qu'ils s'emboîtent à fond contre la fausse quille.

GRÉEMENT

Pour réaliser le gréement de ce bateau, on suivra l'ordre alphabétique des figures imprimées des plans, qui indiquent l'ordre de montage (fils, caps de mouton, poulies, etc.) mis en évidence en rouge. La liste des pièces indique le type de matériaux et les dimensions à utiliser.

Pour simuler le vieillissement des voiles, on peut les faire tremper dans une infusion de thé, sans les faire bouillir, et les laisser sécher bien chiffonnées. Les voiles seront placées non repassées afin d'avoir du volume.

A- Usare una superficie piana e stabile per incollare i pezzi A1 e A2, e rinforzare la loro giunzione con i pezzi A3 e A4. Seguendo l'ordine alfanumerico, inserire e incollare i pezzi indicati nelle figure. Prima di incollare le coste, verificare che si adattino correttamente alla posizione incastrandole nelle corrispondenti sedi della falsa chiglia. È importante che i telai siano completamente perpendicolari alla falsa chiglia in modo che i ponti si adattino correttamente. Per questa operazione usare la colla bianca (rif.19200) come adesivo.

B- Tagliare le strisce di rivestimento e sottolineare i loro bordi con una matita. Iniziare a foderare la copertura inserendo la prima lastra sulla linea della matita mostrata nell'immagine. Incollare le lastre ben vicine tra loro in modo che le giunzioni non siano visibili. Usare la colla a contatto (colla da calzolaio) come adesivo. Strofinare le lastre contro il ponte in modo che aderiscano saldamente. Poi tagliare la lastra in eccesso con un taglierino. Carteggiare il ponte fino ad ottenere una superficie fine e uniforme. Poi rimuovere la polvere di levigatura e applicare un paio di mani di vernice satinata, (Rif.19209), carteggiando tra una e l'altra. Rivestire tutti i ponti come mostrato nelle foto, poi carteggiarli e verniciarli con smalto (Rif.19209).

C-D- Costruire le strutture seguendo l'ordine alfanumerico delle immagini. Utilizzare la colla bianca per questa operazione. Montare e incollare i ponti sulle strutture. Usare lo stucco turapori (Rif.19143) per le strutture. Dopo la levigatura, applicare il primer (Rif.19142).

E- Posizionare lo scafo capovolto e iniziare a carteggiare partendo da prua e procedendo verso poppa. Bisogna sgrossare i bordi delle cornici ma senza deformarne la forma originale. La levigatura dello scafo deve essere simmetrica, cioè il lato destro deve essere lo stesso del sinistro. Per la parte centrale dello scafo, utilizzare un blocco di levigatura con una superficie più ampia. La carteggiatura deve essere progressiva e liscia. Verificare con una striscia che la levigatura sia corretta. Per fare ciò, devi far scorrere la lamella, sopra i telai, per vedere come si adatta alla sua forma.

F-G-H- Iniziare a rivestire lo scafo con le aste F2. Se le aste sono troppo secche e si rompono quando vengono piegate, immergerle in acqua per circa 20 minuti. Questo le renderà di nuovo elastiche. Poi asciugarle con un panno. Incollare la prima asta dalla prua fino alla costa 7 con la colla bianca (rif.19200). Poi inchiodare con chiodini A. Incollare un'altra asta F2 per dare continuità alla prima asta alla parte posteriore dello scafo. Le restanti aste del tavolato devono essere incollate alle coste e tra loro con colla bianca e inchiodati con chiodini. Continuare ad incollare le aste da prua a poppa per allineare l'intero scafo. Sarà necessario tagliare a misura e adattare i pezzi per inserirli nei fori. Se vi sono delle aste allentate in qualsiasi punto, si può applicare della colla ad asciugatura rapida. Se qualche asta è rimasta infossata, incollane un'altra sopra e poi carteggiare. Limare le teste dei chiodini con una lima piatta fino a quando siano a filo con il rivestimento. Diluire un po' di colla bianca con acqua in modo da poterla applicare leggermente e farla penetrare tra le giunture delle aste. Mettere lo scafo da parte fino a quando la colla non si asciuga. Questo unificherà il fasciame dello scafo e lo renderà più coerente. Poi carteggiare l'intero scafo. Deve restare liscio e uniforme.

i-J- Applicare la colla a contatto (colla da calzolaio) sull'area dello scafo mostrata nelle foto. Incollare e attaccare le strisce di rivestimento i1. Devi combinare le strisce i1 per completare la lunghezza totale dello scafo. Tagliare le strisce di rivestimento a misura come richiesto. Strofinare le strisce di rivestimento in modo che aderiscano saldamente.

K- Applicare lo stucco per coprire le crepe (rif.19143) su tutto lo scafo e quando si è asciugato, carteggiarlo fino a che non diventi ben fine al tatto. Ripetere la stessa operazione fino ad ottenere una finitura fine. Applicare il primer (rif.19142) su tutto lo scafo e carteggiare di nuovo. Usare il nastro adesivo per mascherare le aree della struttura dello scafo. Dipingere la parte inferiore dello scafo con vernice verde scuro, (rif.19315). Questa verniciatura può essere effettuata a pennello, a spray o con l'aerografo. Completa lo scafo con i colori bianco (rif.19300), colore ocra chiaro, (rif.19387), e nero (rif.19301).

L- Usare la sagoma PL-01 per identificare le parti e la loro posizione sullo scafo. Con un punteruolo segnare il centro di ogni foro sullo scafo. Poi fare tutti i fori. Procedere allo stesso modo sull'altro lato dello scafo. Inserire e incollare un pezzo C10 in ogni foro.

M a Z- Costruire le strutture seguendo l'ordine alfanumerico delle immagini. Costruisci e decora le barche usando le immagini come guida ai colori. Usa del nastro adesivo per isolare le strutture in modo da poterle decorare con precisione. Costruisci e decora le barche usando le immagini come guida ai colori.

ALBERATURA

Per realizzare l'alberatura, il primo passo da seguire sarà quello di tagliare le aste secondo le misure indicate nell'elenco dei pezzi, oppure prenderle direttamente dalle planimetrie che sono stampate in scala 1/1.

Tutti gli alberi e i pennoni hanno una certa conicità che si dovrà ottenere.

Per ottenere la conicità degli alberi, occorre scartavetrare le aste (con una smerigliatrice), aumentando l'azione della stessa a misura che ci si avvicina all'estremità dove si deve diminuire il diametro. Far girare l'asta affinché la smerigliatura sia uguale su tutto il contorno, fino ad arrivare al diametro indicato nella planimetria.

Per ottenere la conicità dei pennoni, realizzare le stesse operazioni, ma in questo caso su entrambe le estremità dell'asta. Si dovranno verniciare o tingere le aste in funzione del modello che si stia realizzando.

Per realizzare gli alberi di questo modello in maniera corretta si dovranno utilizzare:

- Le planimetrie;
- Le foto dettagliate degli alberi;
- Le misure e la descrizione dei materiali nell'elenco dei pezzi;
- Le pagine "IP" con l'identificazione dei pezzi.
- La sagoma PL-01

Gli alberi devono essere smaltati ed alcuni dei pezzi che li compongono devono essere verniciati. Vedi le foto generali dettagliate degli alberi.

Una volta montati e smaltati, devono essere collocati gli attrezzi (stroppi, quarnali, golfare, bozzelli, ecc.) e fissati al vascello.

Gli alberi devono essere introdotti fino in fondo negli appositi incastri della falsa chiglia.

SARTIA

Per elaborare la sartia di questo vascello occorre seguire l'ordine alfabetico delle figure stampate delle planimetrie, che indicano l'ordine di collocazione delle cime, delle bigotte, dei bozzelli, delle vele, ecc., risaltati in colore rosso. L'elenco dei pezzi serve ad orientare in merito al tipo di materiali ed alle misure da utilizzare.

Per simulare l'invecchiamento delle vele, queste possono essere bagnate con te, senza farle bollire, e poi lasciarle asciugare mantenendole ben arrugate.

Poi si collocano senza stirarle, affinché mantengano corpo.

A. Auf einer ebenen und stabilen Oberfläche die Teile A1 und A2 zusammenkleben und die Verbindung mit den Teilen A3 und A4 verstärken. Die auf den Abbildungen gezeigten Teile in der angegebenen Reihenfolge einsetzen und aufkleben. Vor dem Aufkleben der Spanten sicherstellen, dass die sie korrekt sitzen und mit den dazugehörigen Einkerbungen des falschen Kiels abschließen. Die Spanten müssen vollkommen senkrecht auf dem falschen Kiel stehen, damit danach die Decks gut eingesetzt werden können. Für diesen Schritt weißen Leim (Ref.19200) verwenden.

B. Die Plankenreihe zurechtschneiden und die Kanten mit einem Bleistift hervorheben. Mit dem Beplanken des Decks beginnen und die erste Leiste an der Bleistiftlinie ausrichten. Die Leisten eng zusammenkleben, damit keine Zwischenräume zu sehen sind. Zum Kleben Kontaktkleber verwenden (Schusterleim). Die Leisten an das Deck drücken, damit sie fest sitzen. Anschließend die überstehenden Teile mit einem Cutter abschneiden. Das Deck glatt feilen, so dass eine glatte und gleichmäßige Oberfläche entsteht. Anschließend den Staub mit feinem, trockenem Pinsel entfernen und einige Schichten satinierten Lack (Ref.19209) aufbringen und zwischen zwei Schichten die Fläche glatt schleifen. Die Decks wie auf den Abbildungen gezeigt beplanken und anschließend glattschmiegeln und lackieren (Ref.19209).

C bis D. Die Aufbauten in der auf den Abbildungen angegebenen Reihenfolge anbringen. Dazu weißen Leim verwenden. Die Decks auf die Strukturen anpassen und aufkleben. Für die Strukturen Fugenkitt (Ref.19143) verwenden. Anschließend glätten und Grundierung (Ref.19142) auftragen.

E. Drehen Sie den Rumpf um und beginnen Sie mit dem Schleifen, beginnend am Bug und in Richtung Heck. Sie müssen die Kanten der Rahmen rauhen, ohne jedoch ihre ursprüngliche Form zu verformen. Das Schleifen des Helms muss symmetrisch sein, dh die rechte Seite muss mit der linken identisch sein. Verwenden Sie für die Mitte des Helms einen Schleifblock mit einer größeren Oberfläche. Das Schleifen muss progressiv und glatt sein. Überprüfen Sie mit einem Streifen, ob der Schleifvorgang korrekt ist. Dazu müssen Sie die Lamelle über die Rahmen schieben, um zu sehen, wie sie sich an ihre Form anpasst.

F bis H. Zuerst den Schiffsrumpf mit den Leisten F2 beplanken. Wenn die Leisten sehr trocken sind, ca. 20 Minuten in Wasser einweichen, damit sie nicht brechen. Damit werden sie biegsamer. Anschließend mit einem Tuch trockenreiben. Die erste Leiste vom Bug bis zum Spant 7 aufkleben. Dazu weißen Leim (Ref.19200) verwenden. Danach mit A-Stiften befestigen. Eine weitere Leiste F2 an die erste setzen, die bis zum hinteren Ende des Rumpfs reicht. Die übrigen Leisten an die Spanten und aneinander kleben und mit weißem Leim und Stiften befestigen. Die Beplankung des Rumpfs fortsetzen und Leisten von Bug nach Heck aufkleben. Die Teile für die Zwischenräume nach Maß zurechtschneiden. Lose Planken mit Sekundenkleber festkleben. Wenn eine Planke zu tief eingesunken ist, eine weitere Planke darübersetzen und abschleifen. Die Stiftköpfe mit einer Feile glattfeilen, bis sie auf einer Höhe mit den Plankenreihen sind. Etwas weißen Leim mit Wasser verdünnen, um ihn leichter auftragen zu können, so dass er sich in den Zwischenräume zwischen den Leisten verteilt. Rumpf beiseite stellen, bis der Leim getrocknet ist. Mit diesem Verfahren wird die Rumpfbeplankung verbunden und gewinnt an Stabilität. Anschließend den gesamten Rumpf glatt schmiegeln. Es muss eine glatte und gleichmäßige Oberfläche entstehen.

i bis J. Kontaktkleber (Schusterleim) auf die Rumpfbereiche auftragen, die auf den Abbildungen zu sehen sind. Die Plankenreihe i1 mit Leim bestreichen und aufkleben. Die Leisten i1 kombinieren, um die Gesamtlänge des Rumpfs abzudecken. Die Plankenreihen passend zurechtschneiden. Die Plankenreihe fest andrücken, damit sie haften.

K. Eine Schicht Fugenkitt (Ref.19143) auf die gesamte Oberfläche der Rumpfverkleidung auftragen und nach dem Trocknen glattschmiegeln. Den Vorgang wiederholen, bis eine gleichmäßige Oberfläche entstanden ist. Grundierung (Ref.19142) auf die gesamte Rumpfverkleidung auftragen und erneut glattschmiegeln. Abdeckband verwenden, um Bereiche am Rumpf abzukleben. Die Malen Sie den unteren Teil des Rumpfes dunkelgrün (Ref.19315). Dazu einen Pinsel verwenden oder Sprühfarbe/Airbrush verwenden. Vervollständigen Sie den Rumpf mit den Farben Weiß (Ref.19300), helle Ocker Farbe, (Ref.19387) und Schwarz (Ref.19301).

L. Mithilfe der PL-01-Schablone die Teile an die vorgesehenen Stellen auf dem Rumpf setzen. Mit einem Stichel oder einem anderen spitzen Werkzeug die Stellen markieren, an denen dann die Öffnungen angebracht werden. Anschließend die Öffnungen anbringen. Auf der anderen Seite des Rumpfs ebenso verfahren. Ein Teil C10 in jede Öffnung einsetzen und ankleben.

M bis Z. Die Aufbauten in der auf den Abbildungen angegebenen Reihenfolge anbringen. Baue und dekoriere die Teile und füge sie dem Schiff hinzu, um es zu vervollständigen. Verwenden Sie Abdeckband, um Strukturen zu isolieren, damit Sie sie präzise dekorieren können. Bauen und dekorieren Sie die Boote anhand der Bilder als Farbanleitung.

BEMASTUNG

Zur Herstellung der Masten müssen zuerst die Stäbe entsprechend der Maße zurecht geschnitten werden, die in der Teileliste angegeben sind oder die direkt anhand der Skizze abgemessen wurde. Die Skizzen sind im Maßstab 1/1 angefertigt.

Alle Masten und Rahen müssen leicht konisch verlaufen und vor dem Einbau entsprechen vorbereitet werden.

Um die Masten in Konusform zu bringen, müssen die Masten (mit einer Feile) zurecht geschliffen werden, und zwar in der Form, dass sie nach oben hin verjüngt werden. Die Stäbe dabei drehen und an allen Seiten gleichmäßig abschleifen, bis sie zu dem auf der Skizze angegebenen Durchmesser passen.

Um die Rahen in Konusform zu bringen, ebenso verfahren, allerdings hier an beiden Enden der Stangen.
Die Stäbe in Abhängigkeit von dem Modell färben oder anmalen.

Um die Masten dieses Schiffsbaumodells richtig vorzubereiten, müssen die folgenden Punkte beachtet werden:

- Die Skizzen
- Detailfotos der Masten
- Maße und Materialien der Teileliste
- IP-Blätter zur Identifikation der Bauteile
- Schablone PL-01

Die Masten müssen lackiert werden und einige der Einzelteile der Masten müssen angemalt werden. Siehe Fotos mit allgemeiner Ansicht der Masten

Nach Aufstellung und Lackierung der Masten wird die Takelung (Stroppe, Rollenblöcke, Ösen, Blockrollen etc.) an den Masten und dann am Schiff befestigt. Die Masten müssen eingesetzt werden, bis sie an die Einkerbungen des falschen Kiels stoßen.

TAKELAGE

Zur Takelung des Schiffsmodells die alphabetische Reihenfolge der Abbildungen befolgen, auf denen die Anbringung der Takelung (Faden, Klampböcke, Blockrollen usw.) erläutert wird. Sie sind in Rot hervorgehoben. Auf der Teileliste sehen Sie, welche Materialien zum Bau des Modells notwendig sind.

Zur künstlichen Alterung der Segel die Stoffstücke in Tee legen (nicht kochen) und trocknen lassen, bis die Stoffe faltig werden.

Die Segel ohne vorheriges Bügeln anbringen, damit sie Volumen haben.

Lista de piezas / Parts List / Liste des pièces / Teileliste / Elenco delle parti

Nº/No./N° / Nr. No	Cantidad / Quantity / Quantité / Menge / Quantità	Medidas / Measurements / Dimensions / Maße / Misure	Material / Material / Matériau / Material / Materiale
A1-A2	2	Precortado / Precut / Prédécoupé / Vorgeschnitten/ Pretagliato	Tablero / Plywood / Planche / Sperrholz / Tavola
A3-A4	2	Precortado / Precut / Prédécoupé / Vorgeschnitten/ Pretagliato	Tablero / Plywood / Planche / Sperrholz / Tavola
A5-A19	15	Precortado / Precut / Prédécoupé / Vorgeschnitten/ Pretagliato	Tablero / Plywood / Planche / Sperrholz / Tavola
A20-A21	3	Precortado / Precut / Prédécoupé / Vorgeschnitten/ Pretagliato	Tablero / Plywood / Planche / Sperrholz / Tavola
B1	277	0,6x5x80	Tilo / Lime wood / Tilleul / Linde / Tiglio
B2	1	Precortado / Precut / Prédécoupé / Vorgeschnitten/ Pretagliato	Tablero / Plywood / Planche / Sperrholz / Tavola
B3	1	Precortado / Precut / Prédécoupé / Vorgeschnitten/ Pretagliato	Tablero / Plywood / Planche / Sperrholz / Tavola
B4	1	Precortado / Precut / Prédécoupé / Vorgeschnitten/ Pretagliato	Tablero / Plywood / Planche / Sperrholz / Tavola
C1	1	Precortado / Precut / Prédécoupé / Vorgeschnitten/ Pretagliato	Tablero / Plywood / Planche / Sperrholz / Tavola
C2-C3	4	Precortado / Precut / Prédécoupé / Vorgeschnitten/ Pretagliato	Tablero / Plywood / Planche / Sperrholz / Tavola
C4-C8	6	Precortado / Precut / Prédécoupé / Vorgeschnitten/ Pretagliato	Tablero / Plywood / Planche / Sperrholz / Tavola
C9	1	Precortado / Precut / Prédécoupé / Vorgeschnitten/ Pretagliato	Tablero / Plywood / Planche / Sperrholz / Tavola
C10	192	Preformado / Preformed/ Préformé / Vorgeformt / Preformato	Latón / Brass / Latón / Messing / Ottone
D1	7	Preformado / Preformed/ Préformé / Vorgeformt / Preformato	Metal / Metal / Metal / Metall / Metallo
D2-D6	10	Precortado / Precut / Prédécoupé / Vorgeschnitten/ Pretagliato	Tablero / Plywood / Planche / Sperrholz / Tavola
E1-E4	4	Precortado / Precut / Prédécoupé / Vorgeschnitten/ Pretagliato	Tablero / Plywood / Planche / Sperrholz / Tavola
E5-E7	6	Precortado / Precut / Prédécoupé / Vorgeschnitten/ Pretagliato	Tablero / Plywood / Planche / Sperrholz / Tavola
E8	1	2x7x400	Tilo / Lime wood / Tilleul / Linde / Tiglio
F1	2	Precortado / Precut / Prédécoupé / Vorgeschnitten/ Pretagliato	Tablero / Plywood / Planche / Sperrholz / Tavola
F2	12	2x7x400	Tilo / Lime wood / Tilleul / Linde / Tiglio
G1	120	2x7x400	Tilo / Lime wood / Tilleul / Linde / Tiglio
H1	10	2x7x400	Tilo / Lime wood / Tilleul / Linde / Tiglio
H2	50	2x7x25	Tilo / Lime wood / Tilleul / Linde / Tiglio
H3	7	2x7x15	Tilo / Lime wood / Tilleul / Linde / Tiglio
i1	120	0,6x7x400	Sicomoro / Sycamore / Sycomore / Bergahorn / Sicomoro
J1	10	0,6x7x400	Sicomoro / Sycamore / Sycomore / Bergahorn / Sicomoro
J2	7	0,6x7x15	Sicomoro / Sycamore / Sycomore / Bergahorn / Sicomoro
J3	6	0,6x7x30	Sicomoro / Sycamore / Sycomore / Bergahorn / Sicomoro
J4	25	0,6x7x25	Sicomoro / Sycamore / Sycomore / Bergahorn / Sicomoro
J5	1	Precortado / Precut / Prédécoupé / Vorgeschnitten/ Pretagliato	Tablero / Plywood / Planche / Sperrholz / Tavola
J6	1	Precortado / Precut / Prédécoupé / Vorgeschnitten/ Pretagliato	Tablero / Plywood / Planche / Sperrholz / Tavola
J7	1	Precortado / Precut / Prédécoupé / Vorgeschnitten/ Pretagliato	Tablero / Plywood / Planche / Sperrholz / Tavola
J8	2	5x5x400	Tilo / Lime wood / Tilleul / Linde / Tiglio
K1	1	Precortado / Precut / Prédécoupé / Vorgeschnitten/ Pretagliato	Tablero / Plywood / Planche / Sperrholz / Tavola
K2	27	0,6x5x75	Sicomoro / Sycamore / Sycomore / Bergahorn / Sicomoro
K3	1	Preformado / Preformed/ Préformé / Vorgeformt / Preformato	Metal / Metal / Metal / Metall / Metallo
K4	2	ø1x10	Latón / Brass / Latón / Messing / Ottone
L1	2	Preformado / Preformed/ Préformé / Vorgeformt / Preformato	Metal / Metal / Metal / Metall / Metallo
L2	5	Preformado / Preformed/ Préformé / Vorgeformt / Preformato	Metal / Metal / Metal / Metall / Metallo
L3	2	2x4x9	Tilo / Lime wood / Tilleul / Linde / Tiglio
L4	2	2x4x14	Tilo / Lime wood / Tilleul / Linde / Tiglio
L5	2	2x4x50	Tilo / Lime wood / Tilleul / Linde / Tiglio
L6	2	2x4x19	Tilo / Lime wood / Tilleul / Linde / Tiglio
L7	2	2x4x23	Tilo / Lime wood / Tilleul / Linde / Tiglio
L8	2	2x4x96	Tilo / Lime wood / Tilleul / Linde / Tiglio
L9	1	2x4x39	Tilo / Lime wood / Tilleul / Linde / Tiglio
L10	1	Precortado / Precut / Prédécoupé / Vorgeschnitten/ Pretagliato	Tablero / Plywood / Planche / Sperrholz / Tavola
L11-L12	4	Preformado / Preformed/ Préformé / Vorgeformt / Preformato	Metal / Metal / Metal / Metall / Metallo
L13	2	2x5x10	Tilo / Lime wood / Tilleul / Linde / Tiglio
L14	2	2x5x220	Tilo / Lime wood / Tilleul / Linde / Tiglio
L15	2	Preformado / Preformed/ Préformé / Vorgeformt / Preformato	Metal / Metal / Metal / Metall / Metallo
L16	2	Preformado / Preformed/ Préformé / Vorgeformt / Preformato	Metal / Metal / Metal / Metall / Metallo
L17	2	2x4x46	Tilo / Lime wood / Tilleul / Linde / Tiglio
L18	5	2x4x10	Tilo / Lime wood / Tilleul / Linde / Tiglio
L19	2	2x4x177	Tilo / Lime wood / Tilleul / Linde / Tiglio
M1	1	Precortado / Precut / Prédécoupé / Vorgeschnitten/ Pretagliato	Tablero / Plywood / Planche / Sperrholz / Tavola
M2	2	Precortado / Precut / Prédécoupé / Vorgeschnitten/ Pretagliato	Tablero / Plywood / Planche / Sperrholz / Tavola
M3	34	Preformado / Preformed/ Préformé / Vorgeformt / Preformato	Metal / Metal / Metal / Metall / Metallo
M4-M5	2	Preformado / Preformed/ Préformé / Vorgeformt / Preformato	Latón / Brass / Latón / Messing / Ottone
M6	2	2x4x11	Tilo / Lime wood / Tilleul / Linde / Tiglio
M7	1	Preformado / Preformed/ Préformé / Vorgeformt / Preformato	Latón / Brass / Latón / Messing / Ottone
M8	15	Preformado / Preformed/ Préformé / Vorgeformt / Preformato	Latón / Brass / Latón / Messing / Ottone
M9	4	ø0,50x100	Latón / Brass / Latón / Messing / Ottone

Lista de piezas / Parts List / Liste des pièces / Teileliste / Elenco delle parti

Nº/No./N° / Nr. No	Cantidad / Quantity / Quantité / Menge / Quantità	Medidas / Measurements / Dimensions / Maße / Misure	Material / Material / Matériau / Material / Materiale
M10	17	ø0,50x11	Latón / Brass / Latón / Messing / Ottone
M11	1	Precortado / Precut / Prédécoupé / Vorgeschnitten/ Pretagliato	Tablero / Plywood / Planche / Sperrholz / Tavola
M12	1	Preformado / Preformed/ Préformé / Vorgeformt / Preformato	Metal / Metal / Metal / Metall / Metallo
M13	2	Preformado / Preformed/ Préformé / Vorgeformt / Preformato	Metal / Metal / Metal / Metall / Metallo
N1	88	Preformado / Preformed/ Préformé / Vorgeformt / Preformato	Latón / Brass / Latón / Messing / Ottone
N2	4	ø0,50x75	Latón / Brass / Latón / Messing / Ottone
N3	6	ø0,50x40	Latón / Brass / Latón / Messing / Ottone
N4-N5	3	Precortado / Precut / Prédécoupé / Vorgeschnitten/ Pretagliato	Tablero / Plywood / Planche / Sperrholz / Tavola
N6	2	7x7x52	Tilo / Lime wood / Tilleul / Linde / Tiglio
N7	4	Preformado / Preformed/ Préformé / Vorgeformt / Preformato	Metal / Metal / Metal / Metall / Metallo
N8-N9	3	Precortado / Precut / Prédécoupé / Vorgeschnitten/ Pretagliato	Tablero / Plywood / Planche / Sperrholz / Tavola
O1-O6	14	Precortado / Precut / Prédécoupé / Vorgeschnitten/ Pretagliato	Tablero / Plywood / Planche / Sperrholz / Tavola
O7	2	15x29	Acetato / Acetate / Acétate / Acetat / Acetato
O8	1	15x25	Acetato / Acetate / Acétate / Acetat / Acetato
O9	5	5x15	Acetato / Acetate / Acétate / Acetat / Acetato
O10	20	2x2x11	Tilo / Lime wood / Tilleul / Linde / Tiglio
O11	2	2x2x35	Tilo / Lime wood / Tilleul / Linde / Tiglio
O12	2	1x3x34	Tilo / Lime wood / Tilleul / Linde / Tiglio
O13	10	1x3x15	Tilo / Lime wood / Tilleul / Linde / Tiglio
O14	12	2x2x24	Tilo / Lime wood / Tilleul / Linde / Tiglio
O15	10	Preformado / Preformed/ Préformé / Vorgeformt / Preformato	Metal / Metal / Metal / Metall / Metallo
O16	4	ø0,50x75	Latón / Brass / Latón / Messing / Ottone
O17	1	ø0,50x12	Latón / Brass / Latón / Messing / Ottone
O18	1	ø0,50x100	Latón / Brass / Latón / Messing / Ottone
O19	3	8x15x15	Tilo / Lime wood / Tilleul / Linde / Tiglio
O20	3	Precortado / Precut / Prédécoupé / Vorgeschnitten/ Pretagliato	Tablero / Plywood / Planche / Sperrholz / Tavola
O21	5	Preformado / Preformed/ Préformé / Vorgeformt / Preformato	Metal / Metal / Metal / Metall / Metallo
P1-P4	12	Precortado / Precut / Prédécoupé / Vorgeschnitten/ Pretagliato	Tablero / Plywood / Planche / Sperrholz / Tavola
P5	2	ø0,50x55	Latón / Brass / Latón / Messing / Ottone
P6	2	ø0,50x75	Latón / Brass / Latón / Messing / Ottone
P7	2	ø0,50x60	Latón / Brass / Latón / Messing / Ottone
P8	4	ø0,50x90	Latón / Brass / Latón / Messing / Ottone
P9	4	ø1x30	Latón / Brass / Latón / Messing / Ottone
P10	2	ø1x32	Latón / Brass / Latón / Messing / Ottone
P11	6	ø1x14	Latón / Brass / Latón / Messing / Ottone
P12	4	Preformado / Preformed/ Préformé / Vorgeformt / Preformato	Metal / Metal / Metal / Metall / Metallo
P13	18	Preformado / Preformed/ Préformé / Vorgeformt / Preformato	Madera / Wood / Bois / Holz / Legno
P14	12	2x2x6	Tilo / Lime wood / Tilleul / Linde / Tiglio
P15	8	Precortado / Precut / Prédécoupé / Vorgeschnitten/ Pretagliato	Tablero / Plywood / Planche / Sperrholz / Tavola
P16	4	2x4x5	Tilo / Lime wood / Tilleul / Linde / Tiglio
P17	2	2x4x20	Tilo / Lime wood / Tilleul / Linde / Tiglio
P18	2	2x4x30	Tilo / Lime wood / Tilleul / Linde / Tiglio
Q1-Q2	18	Precortado / Precut / Prédécoupé / Vorgeschnitten/ Pretagliato	Tablero / Plywood / Planche / Sperrholz / Tavola
Q3	48	1x3x13	Tilo / Lime wood / Tilleul / Linde / Tiglio
Q4	66	1x3x20	Tilo / Lime wood / Tilleul / Linde / Tiglio
Q5	30	ø0,50x30	Latón / Brass / Latón / Messing / Ottone
Q6	4	4x4x15	Tilo / Lime wood / Tilleul / Linde / Tiglio
Q7	4	Preformado / Preformed/ Préformé / Vorgeformt / Preformato	Metal / Metal / Metal / Metall / Metallo
Q8	12	Preformado / Preformed/ Préformé / Vorgeformt / Preformato	Metal / Metal / Metal / Metall / Metallo
Q9	6	Precortado / Precut / Prédécoupé / Vorgeschnitten/ Pretagliato	Tablero / Plywood / Planche / Sperrholz / Tavola
Q10	6	2x5x25	Tilo / Lime wood / Tilleul / Linde / Tiglio
Q11	2	2x5x45	Tilo / Lime wood / Tilleul / Linde / Tiglio
Q12	18	Preformado / Preformed/ Préformé / Vorgeformt / Preformato	Metal / Metal / Metal / Metall / Metallo
Q13	2	7x7x145	Tilo / Lime wood / Tilleul / Linde / Tiglio
Q14	12	2x2x7	Tilo / Lime wood / Tilleul / Linde / Tiglio
Q15	6	1x3x147	Tilo / Lime wood / Tilleul / Linde / Tiglio
R1	1	ø0,50x35	Latón / Brass / Latón / Messing / Ottone
R2	1	ø0,50x55	Latón / Brass / Latón / Messing / Ottone
R3	1	ø8x100	Tilo / Lime wood / Tilleul / Linde / Tiglio
R4	1	ø12x47	Tilo / Lime wood / Tilleul / Linde / Tiglio
R5	1	Precortado / Precut / Prédécoupé / Vorgeschnitten/ Pretagliato	Tablero / Plywood / Planche / Sperrholz / Tavola
R6	1	4x4x15	Tilo / Lime wood / Tilleul / Linde / Tiglio
R7-R8	2	Precortado / Precut / Prédécoupé / Vorgeschnitten/ Pretagliato	Tablero / Plywood / Planche / Sperrholz / Tavola

Lista de piezas / Parts List / Liste des pièces / Teileliste / Elenco delle parti

Nº/No./N° / Nr. No	Cantidad / Quantity / Quantité / Menge / Quantità	Medidas / Measurements / Dimensions / Maße / Misure	Material / Material / Matériau / Material / Materiale
R9	1	Preformado / Prefomed/ Préformé / Vorgeformt / Preformato	Metal / Metal / Metal / Metall / Metallo
R10	2	Preformado / Prefomed/ Préformé / Vorgeformt / Preformato	Metal / Metal / Metal / Metall / Metallo
R11	1	Preformado / Prefomed/ Préformé / Vorgeformt / Preformato	Metal / Metal / Metal / Metall / Metallo
R12	1	Preformado / Prefomed/ Préformé / Vorgeformt / Preformato	Metal / Metal / Metal / Metall / Metallo
R13	1	Preformado / Prefomed/ Préformé / Vorgeformt / Preformato	Latón / Brass / Latón / Messing / Ottone
R14	1	Preformado / Prefomed/ Préformé / Vorgeformt / Preformato	Metal / Metal / Metal / Metall / Metallo
R15	1	Preformado / Prefomed/ Préformé / Vorgeformt / Preformato	Metal / Metal / Metal / Metall / Metallo
R16	1	ø3x100	Tilo / Lime wood / Tilleul / Linde / Tiglio
R17	4	Preformado / Prefomed/ Préformé / Vorgeformt / Preformato	Metal / Metal / Metal / Metall / Metallo
R18	4	ø1x18	Latón / Brass / Latón / Messing / Ottone
R19	3	ø1x33	Latón / Brass / Latón / Messing / Ottone
R20	7	4x8x18	Tilo / Lime wood / Tilleul / Linde / Tiglio
R21	1	4x8x10	Tilo / Lime wood / Tilleul / Linde / Tiglio
R22	3	Preformado / Prefomed/ Préformé / Vorgeformt / Preformato	Metal / Metal / Metal / Metall / Metallo
R23	4	Preformado / Prefomed/ Préformé / Vorgeformt / Preformato	Metal / Metal / Metal / Metall / Metallo
R24	3	Preformado / Prefomed/ Préformé / Vorgeformt / Preformato	Metal / Metal / Metal / Metall / Metallo
R25	6	Preformado / Prefomed/ Préformé / Vorgeformt / Preformato	Metal / Metal / Metal / Metall / Metallo
R26	2	Preformado / Prefomed/ Préformé / Vorgeformt / Preformato	Metal / Metal / Metal / Metall / Metallo
R27	4	Preformado / Prefomed/ Préformé / Vorgeformt / Preformato	Metal / Metal / Metal / Metall / Metallo
S1-S8	14	Precortado / Precut / Prédécoupé / Vorgeschnitten/ Pretagliato	Tablero / Plywood / Planche / Sperrholz / Tavola
S9	10	2x2x14	Tilo / Lime wood / Tilleul / Linde / Tiglio
S10	4	2x2x15	Tilo / Lime wood / Tilleul / Linde / Tiglio
S11	4	2x2x51	Tilo / Lime wood / Tilleul / Linde / Tiglio
S12	1	Preformado / Prefomed/ Préformé / Vorgeformt / Preformato	Composite / Composite / Composite / Composite / Composite
S13	4	Preformado / Prefomed/ Préformé / Vorgeformt / Preformato	Metal / Metal / Metal / Metall / Metallo
S14	3	Preformado / Prefomed/ Préformé / Vorgeformt / Preformato	Metal / Metal / Metal / Metall / Metallo
S15	2	ø1x10	Latón / Brass / Latón / Messing / Ottone
S16-S22	7	Preformado / Prefomed/ Préformé / Vorgeformt / Preformato	Acetato / Acetate / Acétate / Acetat / Acetato
S23	2	2x2x50	Tilo / Lime wood / Tilleul / Linde / Tiglio
S24	2	2x2x58	Tilo / Lime wood / Tilleul / Linde / Tiglio
S25	1	2x2x40	Tilo / Lime wood / Tilleul / Linde / Tiglio
S26	1	2x2x40	Tilo / Lime wood / Tilleul / Linde / Tiglio
S27	4	2x2x8	Tilo / Lime wood / Tilleul / Linde / Tiglio
S28	2	2x2x18	Tilo / Lime wood / Tilleul / Linde / Tiglio
S29	2	2x2x13	Tilo / Lime wood / Tilleul / Linde / Tiglio
S30	1	2x2x13	Tilo / Lime wood / Tilleul / Linde / Tiglio
S31	2	2x2x10	Tilo / Lime wood / Tilleul / Linde / Tiglio
S32	2	1x3x45	Tilo / Lime wood / Tilleul / Linde / Tiglio
S33	3	1x3x14	Tilo / Lime wood / Tilleul / Linde / Tiglio
S34	2	1x3x47	Tilo / Lime wood / Tilleul / Linde / Tiglio
S35	2	1x3x16	Tilo / Lime wood / Tilleul / Linde / Tiglio
S36	18	1x3x5	Tilo / Lime wood / Tilleul / Linde / Tiglio
S37	2	1x3x8	Tilo / Lime wood / Tilleul / Linde / Tiglio
S38	2	1x3x6	Tilo / Lime wood / Tilleul / Linde / Tiglio
T1-T5	6	Precortado / Precut / Prédécoupé / Vorgeschnitten/ Pretagliato	Tablero / Plywood / Planche / Sperrholz / Tavola
T6-T7	3	Precortado / Precut / Prédécoupé / Vorgeschnitten/ Pretagliato	Tablero / Plywood / Planche / Sperrholz / Tavola
T8	4	2x7x24	Tilo / Lime wood / Tilleul / Linde / Tiglio
T9	2	2x2x27	Tilo / Lime wood / Tilleul / Linde / Tiglio
T10	2	2x2x44	Tilo / Lime wood / Tilleul / Linde / Tiglio
T11	1	1x3x27	Tilo / Lime wood / Tilleul / Linde / Tiglio
T12	2	1x3x42	Tilo / Lime wood / Tilleul / Linde / Tiglio
T13	1	8x15x20	Tilo / Lime wood / Tilleul / Linde / Tiglio
T14	2	Preformado / Prefomed/ Préformé / Vorgeformt / Preformato	Metal / Metal / Metal / Metall / Metallo
T15	2	ø1x38	Latón / Brass / Latón / Messing / Ottone
T16	1	ø1x25	Latón / Brass / Latón / Messing / Ottone
T17	1	ø1x26	Latón / Brass / Latón / Messing / Ottone
T18	4	Preformado / Prefomed/ Préformé / Vorgeformt / Preformato	Metal / Metal / Metal / Metall / Metallo
T19-T20	9	Precortado / Precut / Prédécoupé / Vorgeschnitten/ Pretagliato	Tablero / Plywood / Planche / Sperrholz / Tavola
T21	2	Precortado / Precut / Prédécoupé / Vorgeschnitten/ Pretagliato	Tablero / Plywood / Planche / Sperrholz / Tavola
T22	18	0,6x5x13	Sicomoro / Sycamore / Sycomore / Bergahorn / Sicomoro
T23	2	Preformado / Prefomed/ Préformé / Vorgeformt / Preformato	Metal / Metal / Metal / Metall / Metallo
T24	6	Preformado / Prefomed/ Préformé / Vorgeformt / Preformato	Metal / Metal / Metal / Metall / Metallo
T25	3	Preformado / Prefomed/ Préformé / Vorgeformt / Preformato	Metal / Metal / Metal / Metall / Metallo

Lista de piezas / Parts List / Liste des pièces / Teileliste / Elenco delle parti

Nº/No./N° / Nr. No	Cantidad / Quantity / Quantité / Menge / Quantità	Medidas / Measurements / Dimensions / Maße / Misure	Material / Material / Matériau / Material / Materiale
U1	6	Preformado / Prefomed/ Préformé / Vorgeformt / Preformato	Metal / Metal / Metal / Metall / Metallo
U2	6	Preformado / Prefomed/ Préformé / Vorgeformt / Preformato	Metal / Metal / Metal / Metall / Metallo
U3	4	Preformado / Prefomed/ Préformé / Vorgeformt / Preformato	Metal / Metal / Metal / Metall / Metallo
U4	10	Preformado / Prefomed/ Préformé / Vorgeformt / Preformato	Metal / Metal / Metal / Metall / Metallo
U5	3	Preformado / Prefomed/ Préformé / Vorgeformt / Preformato	Metal / Metal / Metal / Metall / Metallo
U6	2	Preformado / Prefomed/ Préformé / Vorgeformt / Preformato	Metal / Metal / Metal / Metall / Metallo
U7	6	Preformado / Prefomed/ Préformé / Vorgeformt / Preformato	Metal / Metal / Metal / Metall / Metallo
U8	10	4x4x47	Tilo / Lime wood / Tilleul / Linde / Tiglio
U9	8	Precortado / Precut / Prédécoupé / Vorgeschnitten/ Pretagliato	Tablero / Plywood / Planche / Sperrholz / Tavola
U10	2	4x4x21	Tilo / Lime wood / Tilleul / Linde / Tiglio
U11	1	7x7x15	Tilo / Lime wood / Tilleul / Linde / Tiglio
U12	1	7x7x30	Tilo / Lime wood / Tilleul / Linde / Tiglio
U13	2	8x15x11	Tilo / Lime wood / Tilleul / Linde / Tiglio
U14	2	ø8x33	Tilo / Lime wood / Tilleul / Linde / Tiglio
U15	1	Preformado / Prefomed/ Préformé / Vorgeformt / Preformato	Metal / Metal / Metal / Metall / Metallo
U16	1	Preformado / Prefomed/ Préformé / Vorgeformt / Preformato	Metal / Metal / Metal / Metall / Metallo
U17	2	Preformado / Prefomed/ Préformé / Vorgeformt / Preformato	Latón / Brass / Latón / Messing / Ottone
V1	4	Preformado / Prefomed/ Préformé / Vorgeformt / Preformato	Metal / Metal / Metal / Metall / Metallo
V2	4	Preformado / Prefomed/ Préformé / Vorgeformt / Preformato	Metal / Metal / Metal / Metall / Metallo
V3	6	Preformado / Prefomed/ Préformé / Vorgeformt / Preformato	Latón / Brass / Latón / Messing / Ottone
V4	2	Preformado / Prefomed/ Préformé / Vorgeformt / Preformato	Latón / Brass / Latón / Messing / Ottone
V5	2	ø0,15x100	Hilo crudo / Raw thread / Fil brut / Rohes Baumwollfaden / Filo crudo
V6	2	Preformado / Prefomed/ Préformé / Vorgeformt / PreformatoMe	Metal / Metal / Metal / Metall / Metallo
V7	2	Preformado / Prefomed/ Préformé / Vorgeformt / PreformatoMe	Metal / Metal / Metal / Metall / Metallo
V8	2	Preformado / Prefomed/ Préformé / Vorgeformt / PreformatoMe	Madera / Wood / Bois / Holz / Legno
V9	2	ø3x50	Tilo / Lime wood / Tilleul / Linde / Tiglio
V10	4	ø1x50	Latón / Brass / Latón / Messing / Ottone
V11-V12	2	Preformado / Prefomed/ Préformé / Vorgeformt / PreformatoMe	Latón / Brass / Latón / Messing / Ottone
V13	2	Preformado / Prefomed/ Préformé / Vorgeformt / PreformatoMe	Latón / Brass / Latón / Messing / Ottone
V14	60	Preformado / Prefomed/ Préformé / Vorgeformt / PreformatoMe	Latón / Brass / Latón / Messing / Ottone
V15	86	Preformado / Prefomed/ Préformé / Vorgeformt / PreformatoMe	Metal / Metal / Metal / Metall / Metallo
W1	2	Precortado / Precut / Prédécoupé / Vorgeschnitten/ Pretagliato	Tablero / Plywood / Planche / Sperrholz / Tavola
W2	18	Preformado / Prefomed/ Préformé / Vorgeformt / PreformatoMe	Metal / Metal / Metal / Metall / Metallo
W3	2	Precortado / Precut / Prédécoupé / Vorgeschnitten/ Pretagliato	Tablero / Plywood / Planche / Sperrholz / Tavola
W4	18	ø1x20	Latón / Brass / Latón / Messing / Ottone
W5	2	ø1x35	Latón / Brass / Latón / Messing / Ottone
W6	18	ø0,15x100	Hilo crudo / Raw thread / Fil brut / Rohes Baumwollfaden / Filo crudo
W7	2	ø0,15x100	Hilo crudo / Raw thread / Fil brut / Rohes Baumwollfaden / Filo crudo
W8	2	ø0,15x100	Hilo crudo / Raw thread / Fil brut / Rohes Baumwollfaden / Filo crudo
W9	1	Preformado / Prefomed/ Préformé / Vorgeformt / PreformatoMe	Metal / Metal / Metal / Metall / Metallo
W10	2	1x50	Latón / Brass / Latón / Messing / Ottone
W11	2	1x100	Latón / Brass / Latón / Messing / Ottone
W12	14	Preformado / Prefomed/ Préformé / Vorgeformt / PreformatoMe	Metal / Metal / Metal / Metall / Metallo
X1	9	Precortado / Precut / Prédécoupé / Vorgeschnitten/ Pretagliato	Tablero / Plywood / Planche / Sperrholz / Tavola
X2	6	ø0,50x50	Latón / Brass / Latón / Messing / Ottone
X3	12	ø0,50x45	Latón / Brass / Latón / Messing / Ottone
X4	6	ø0,50x50	Latón / Brass / Latón / Messing / Ottone
X5	6	ø0,50x60	Latón / Brass / Latón / Messing / Ottone
X6	7	ø0,50x45	Latón / Brass / Latón / Messing / Ottone
X7	14	Preformado / Prefomed/ Préformé / Vorgeformt / PreformatoMe	Cristal / Glass / Verre / Glas / Cristallo
X8	3	ø1x15	Latón / Brass / Latón / Messing / Ottone
X9	3	ø1x38	Latón / Brass / Latón / Messing / Ottone
X10	6	ø0,15x50	Hilo crudo / Raw thread / Fil brut / Rohes Baumwollfaden / Filo crudo
X11	3	ø0,15x100	Hilo crudo / Raw thread / Fil brut / Rohes Baumwollfaden / Filo crudo
X12	1	ø0,15x250	Hilo crudo / Raw thread / Fil brut / Rohes Baumwollfaden / Filo crudo
X13	1	ø0,15x200	Hilo crudo / Raw thread / Fil brut / Rohes Baumwollfaden / Filo crudo
Y1	4	Preformado / Prefomed/ Préformé / Vorgeformt / PreformatoMe	Metal / Metal / Metal / Metall / Metallo
Y2	8	2x2x8	Tilo / Lime wood / Tilleul / Linde / Tiglio
Y3	4	2x2x16	Tilo / Lime wood / Tilleul / Linde / Tiglio
Y4	16	2x4x14	Tilo / Lime wood / Tilleul / Linde / Tiglio
Y5	8	2x4x45	Tilo / Lime wood / Tilleul / Linde / Tiglio
Y6	4	Preformado / Prefomed/ Préformé / Vorgeformt / Preformato	Metal / Metal / Metal / Metall / Metallo
Y7	1	Preformado / Prefomed/ Préformé / Vorgeformt / Preformato	Metal / Metal / Metal / Metall / Metallo

Lista de piezas / Parts List / Liste des pièces / Teileliste / Elenco delle parti

Nº/No./N° / Nr. No	Cantidad / Quantity / Quantité / Menge / Quantità	Medidas / Measurements / Dimensions / Maße / Misure	Material / Material / Matériau / Material / Materiale
Y8	1	2x2x65	Tilo / Lime wood / Tilleul / Linde / Tiglio
Y9	2	2x2x5	Tilo / Lime wood / Tilleul / Linde / Tiglio
Y10	2	2x2x37	Tilo / Lime wood / Tilleul / Linde / Tiglio
Y11	2	2x2x8	Tilo / Lime wood / Tilleul / Linde / Tiglio
Y12	3	2x2x18	Tilo / Lime wood / Tilleul / Linde / Tiglio
Y13	2	2x2x15	Tilo / Lime wood / Tilleul / Linde / Tiglio
Y14	14	ø0,15x100	Hilo crudo / Raw thread / Fil brut / Rohes Baumwollfaden / Filo crudo
Y15	14	ø0,15x200	Hilo crudo / Raw thread / Fil brut / Rohes Baumwollfaden / Filo crudo
Y16	12	ø0,15x100	Hilo crudo / Raw thread / Fil brut / Rohes Baumwollfaden / Filo crudo
Z1	4	Preformado / Preformed/ Préformé / Vorgeformt / PreformatoMe	Metal / Metal / Metal / Metall / Metallo
Z2	4	7x7x10	Tilo / Lime wood / Tilleul / Linde / Tiglio
Z3	4	2x2x5	Tilo / Lime wood / Tilleul / Linde / Tiglio
Z4	4	2x4x15	Tilo / Lime wood / Tilleul / Linde / Tiglio
Z5	4	Preformado / Preformed/ Préformé / Vorgeformt / Preformato	Metal / Metal / Metal / Metall / Metallo
Z6	2	Preformado / Preformed/ Préformé / Vorgeformt / Preformato	Metal / Metal / Metal / Metall / Metallo
Z7	1	Preformado / Preformed/ Préformé / Vorgeformt / Preformato	Metal / Metal / Metal / Metall / Metallo
Z8	2	Precortado / Precut / Prédécoupé / Vorgeschnitten/ Pretagliato	Tablero / Plywood / Planche / Sperrholz / Tavola
Z9	1	Preformado / Preformed/ Préformé / Vorgeformt / Preformato	Metal / Metal / Metal / Metall / Metallo
Z10	3	1x3x3	Tilo / Lime wood / Tilleul / Linde / Tiglio
Z11	8	1x3x10	Tilo / Lime wood / Tilleul / Linde / Tiglio
Z12	4	ø0,50x15	Latón / Brass / Latón / Messing / Ottone
Z13	2	1x3x8	Tilo / Lime wood / Tilleul / Linde / Tiglio
Z14	4	1x3x4	Tilo / Lime wood / Tilleul / Linde / Tiglio
Z15	8	ø0,15x200	Hilo crudo / Raw thread / Fil brut / Rohes Baumwollfaden / Filo crudo
Z16-Z18	4	Precortado / Precut / Prédécoupé / Vorgeschnitten/ Pretagliato	Tablero / Plywood / Planche / Sperrholz / Tavola
Z19	1	Preformado / Preformed/ Préformé / Vorgeformt / Preformato	Metal / Metal / Metal / Metall / Metallo
Z20	4	ø0,50x30	Latón / Brass / Latón / Messing / Ottone
Z21	1	Preformado / Preformed/ Préformé / Vorgeformt / Preformato	Composite / Composite / Composite / Composite / Composite
Z22	4	ø0,50x100	Hilo marrón / Brown thread / Fil brun /braunes Baumwollfaden / Filo marrone
Z23	2	ø0,50x250	Hilo marrón / Brown thread / Fil brun /braunes Baumwollfaden / Filo marrone
MT1	1	ø8x117	Tilo / Lime wood / Tilleul / Linde / Tiglio
MT2	1	Preformado / Preformed/ Préformé / Vorgeformt / Preformato	Metal / Metal / Metal / Metall / Metallo
MT3	1	ø6x164	Tilo / Lime wood / Tilleul / Linde / Tiglio
MT4	1	Preformado / Preformed/ Préformé / Vorgeformt / Preformato	Metal / Metal / Metal / Metall / Metallo
MT5	2	Precortado / Precut / Prédécoupé / Vorgeschnitten/ Pretagliato	Tablero / Plywood / Planche / Sperrholz / Tavola
MT6	1	ø4x145	Tilo / Lime wood / Tilleul / Linde / Tiglio
MT7	1	ø3x40	Tilo / Lime wood / Tilleul / Linde / Tiglio
MT8	2	ø3x75	Tilo / Lime wood / Tilleul / Linde / Tiglio
MT9	1	ø8x212	Tilo / Lime wood / Tilleul / Linde / Tiglio
MT10	1	Precortado / Precut / Prédécoupé / Vorgeschnitten/ Pretagliato	Tablero / Plywood / Planche / Sperrholz / Tavola
MT10a	1	2x2x23	Tilo / Lime wood / Tilleul / Linde / Tiglio
MT11	4	2x4x18	Tilo / Lime wood / Tilleul / Linde / Tiglio
MT12	14	Preformado / Preformed/ Préformé / Vorgeformt / Preformato	Latón / Brass / Latón / Messing / Ottone
MT13	6	ø0,50x34	Latón / Brass / Latón / Messing / Ottone
MT14	2	Preformado / Preformed/ Préformé / Vorgeformt / Preformato	Metal / Metal / Metal / Metall / Metallo
MT15	2	Preformado / Preformed/ Préformé / Vorgeformt / Preformato	Metal / Metal / Metal / Metall / Metallo
MT16	4	Precortado / Precut / Prédécoupé / Vorgeschnitten/ Pretagliato	Tablero / Plywood / Planche / Sperrholz / Tavola
MT17	2	2x4x35	Tilo / Lime wood / Tilleul / Linde / Tiglio
MT18	2	2x2x6	Tilo / Lime wood / Tilleul / Linde / Tiglio
MT19	2	Precortado / Precut / Prédécoupé / Vorgeschnitten/ Pretagliato	Tablero / Plywood / Planche / Sperrholz / Tavola
MT20	1	Precortado / Precut / Prédécoupé / Vorgeschnitten/ Pretagliato	Tablero / Plywood / Planche / Sperrholz / Tavola
MT21	1	4x4x10	Tilo / Lime wood / Tilleul / Linde / Tiglio
MT22	1	Preformado / Preformed/ Préformé / Vorgeformt / Preformato	Metal / Metal / Metal / Metall / Metallo
MT23	4	ø1x80	Latón / Brass / Latón / Messing / Ottone
MT24	1	Preformado / Preformed/ Préformé / Vorgeformt / Preformato	Composite / Composite / Composite / Composite / Composite
MT25	2	Precortado / Precut / Prédécoupé / Vorgeschnitten/ Pretagliato	Tablero / Plywood / Planche / Sperrholz / Tavola
MT26	1	ø6x152	Tilo / Lime wood / Tilleul / Linde / Tiglio
MT27	2	Preformado / Preformed/ Préformé / Vorgeformt / Preformato	Metal / Metal / Metal / Metall / Metallo
MT28	2	Precortado / Precut / Prédécoupé / Vorgeschnitten/ Pretagliato	Tablero / Plywood / Planche / Sperrholz / Tavola
MT29	4	2x2x20	Tilo / Lime wood / Tilleul / Linde / Tiglio
MT30	2	2x2x5	Tilo / Lime wood / Tilleul / Linde / Tiglio
MT31	2	Precortado / Precut / Prédécoupé / Vorgeschnitten/ Pretagliato	Tablero / Plywood / Planche / Sperrholz / Tavola
MT32	1	ø4x138	Tilo / Lime wood / Tilleul / Linde / Tiglio







Lista de piezas / Parts List / Liste des pièces / Teileliste / Elenco delle parti

Nº/No./N° / Nr. No	Cantidad / Quantity / Quantité / Menge / Quantità	Medidas / Measurements / Dimensions / Maße / Misure	Material / Material / Matériau / Material / Materiale
MT33	3	ø3	Cristal / Glass / Verre / Glas / Cristallo
MT34	3	ø1x12	Latón / Brass / Latón / Messing / Ottone
MT35	1	ø6x245	Tilo / Lime wood / Tilleul / Linde / Tiglio
MT36	2	ø0,50x105	Latón / Brass / Latón / Messing / Ottone
MT37	6	ø0,50x90	Hilo marrón / Brown thread / Fil brun /braunes Baumwollfaden / Filo marrone
MT38	3	ø1x60	Latón / Brass / Latón / Messing / Ottone
MT39	6	ø5x2	Madera / Wood / Bois / Holz / Legno
MT40	3	ø6	Latón / Brass / Latón / Messing / Ottone
MT41	3	1x75	Latón / Brass / Latón / Messing / Ottone
MT42	2	ø0,50x150	Hilo marrón / Brown thread / Fil brun /braunes Baumwollfaden / Filo marrone
MT43	1	ø5x225	Tilo / Lime wood / Tilleul / Linde / Tiglio
MT44	2	ø0,50x95	Latón / Brass / Latón / Messing / Ottone
MT45	2	ø0,50x140	Hilo marrón / Brown thread / Fil brun /braunes Baumwollfaden / Filo marrone
MT46	1	ø4x190	Tilo / Lime wood / Tilleul / Linde / Tiglio
MT47	2	ø0,50x80	Latón / Brass / Latón / Messing / Ottone
MT48	9	Precortado / Precut / Prédécoupé / Vorgeschnitten/ Pretagliato	Tablero / Plywood / Planche / Sperrholz / Tavola
MT49	3	ø0,50x60	Hilo marrón / Brown thread / Fil brun /braunes Baumwollfaden / Filo marrone
MT50	2	ø0,50x130	Hilo marrón / Brown thread / Fil brun /braunes Baumwollfaden / Filo marrone
MT51	1	ø4x125	Tilo / Lime wood / Tilleul / Linde / Tiglio
MT52	2	ø0,50x46	Latón / Brass / Latón / Messing / Ottone
MT53	2	ø0,50x80	Hilo marrón / Brown thread / Fil brun /braunes Baumwollfaden / Filo marrone
MT54	2	ø0,50x120	Hilo marrón / Brown thread / Fil brun /braunes Baumwollfaden / Filo marrone
MT55	1	ø4x80	Tilo / Lime wood / Tilleul / Linde / Tiglio
MT56	2	ø0,50x32	Latón / Brass / Latón / Messing / Ottone
MT57	2	ø0,50x100	Hilo marrón / Brown thread / Fil brun /braunes Baumwollfaden / Filo marrone
MT58	2	ø3x110	Tilo / Lime wood / Tilleul / Linde / Tiglio
MT59	1	ø8x238	Tilo / Lime wood / Tilleul / Linde / Tiglio
MT60	2	2x4x30	Tilo / Lime wood / Tilleul / Linde / Tiglio
MT61	1	10x30	Composite / Composite / Composite / Composite / Composite
MT62	1	ø6x165	Tilo / Lime wood / Tilleul / Linde / Tiglio
MT63	1	ø4x138	Tilo / Lime wood / Tilleul / Linde / Tiglio
MT64	1	ø6x290	Tilo / Lime wood / Tilleul / Linde / Tiglio
MT65	2	ø0,50x128	Latón / Brass / Latón / Messing / Ottone
MT66	6	ø0,50x95	Hilo marrón / Brown thread / Fil brun /braunes Baumwollfaden / Filo marrone
MT67	2	ø0,50x175	Hilo marrón / Brown thread / Fil brun /braunes Baumwollfaden / Filo marrone
MT68	1	ø5x250	Tilo / Lime wood / Tilleul / Linde / Tiglio
MT69	2	ø0,50x100	Latón / Brass / Latón / Messing / Ottone
MT70	2	ø0,50x160	Hilo marrón / Brown thread / Fil brun /braunes Baumwollfaden / Filo marrone
MT71	1	ø4x207	Tilo / Lime wood / Tilleul / Linde / Tiglio
MT72	2	ø0,50x83	Latón / Brass / Latón / Messing / Ottone
MT73	3	ø0,50x70	Hilo marrón / Brown thread / Fil brun /braunes Baumwollfaden / Filo marrone
MT74	2	ø0,50x145	Hilo marrón / Brown thread / Fil brun /braunes Baumwollfaden / Filo marrone
MT75	1	ø4x137	Tilo / Lime wood / Tilleul / Linde / Tiglio
MT76	2	ø0,50x60	Latón / Brass / Latón / Messing / Ottone
MT77	2	ø0,50x80	Hilo marrón / Brown thread / Fil brun /braunes Baumwollfaden / Filo marrone
MT78	2	ø0,50x100	Hilo marrón / Brown thread / Fil brun /braunes Baumwollfaden / Filo marrone
MT79	1	ø4x105	Tilo / Lime wood / Tilleul / Linde / Tiglio
MT80	2	ø0,50x50	Latón / Brass / Latón / Messing / Ottone
MT81	2	ø0,50x90	Hilo marrón / Brown thread / Fil brun /braunes Baumwollfaden / Filo marrone
MT82	1	ø6x174	Tilo / Lime wood / Tilleul / Linde / Tiglio
MT83	1	Preformado / Preformed/ Préformé / Vorgeformt / Preformato	Metal / Metal / Metal / Metall / Metallo
MT84	2	Precortado / Precut / Prédécoupé / Vorgeschnitten/ Pretagliato	Tablero / Plywood / Planche / Sperrholz / Tavola
MT85	2	2x4x25	Tilo / Lime wood / Tilleul / Linde / Tiglio
MT86	1	2x2x8	Tilo / Lime wood / Tilleul / Linde / Tiglio
MT87	1	Precortado / Precut / Prédécoupé / Vorgeschnitten/ Pretagliato	Tablero / Plywood / Planche / Sperrholz / Tavola
MT88	4	Preformado / Preformed/ Préformé / Vorgeformt / Preformato	Latón / Brass / Latón / Messing / Ottone
MT89	2	ø0,50x25	Latón / Brass / Latón / Messing / Ottone
MT90	1	10x25	Composite / Composite / Composite / Composite / Composite
MT91	1	Precortado / Precut / Prédécoupé / Vorgeschnitten/ Pretagliato	Tablero / Plywood / Planche / Sperrholz / Tavola
MT92	1	Preformado / Preformed/ Préformé / Vorgeformt / Preformato	Metal / Metal / Metal / Metall / Metallo
MT93	1	ø4x114	Tilo / Lime wood / Tilleul / Linde / Tiglio
MT94	2	2x2x14	Tilo / Lime wood / Tilleul / Linde / Tiglio
MT95	1	Precortado / Precut / Prédécoupé / Vorgeschnitten/ Pretagliato	Tablero / Plywood / Planche / Sperrholz / Tavola

Lista de piezas / Parts List / Liste des pièces / Teileliste / Elenco delle parti

Nº/No./ N° / Nr. / No	Cantidad / Quantity / Quantité / Menge / Quantità	Medidas / Measurements / Dimensions /Maße / Misure	Material / Material / Matériau / Material / Materiale
MT96	1	2x2x6	Tilo / Lime wood / Tilleul / Linde / Tiglio
MT97	1	Precortado / Precut / Prédécoupé / Vorgeschnitten/ Pretagliato	Tablero / Plywood / Planche / Sperrholz / Tavola
MT98	1	ø3x102	Tilo / Lime wood / Tilleul / Linde / Tiglio
MT99	1	ø5x180	Tilo / Lime wood / Tilleul / Linde / Tiglio
MT100	2	ø0,50x75	Latón / Brass / Latón / Messing / Ottone
MT101	6	ø0,50x80	Hilo marrón / Brown thread / Fil brun /braunes Baumwollfaden / Filo marrone
MT102	4	ø0,50x9	Hilo marrón / Brown thread / Fil brun /braunes Baumwollfaden / Filo marrone
MT103	2	ø0,50x150	Hilo marrón / Brown thread / Fil brun /braunes Baumwollfaden / Filo marrone
MT104	1	ø4x165	Tilo / Lime wood / Tilleul / Linde / Tiglio
MT105	2	ø0,50x70	Latón / Brass / Latón / Messing / Ottone
MT106	2	ø0,50x135	Hilo marrón / Brown thread / Fil brun /braunes Baumwollfaden / Filo marrone
MT107	1	ø4x130	Tilo / Lime wood / Tilleul / Linde / Tiglio
MT108	2	ø0,50x47	Latón / Brass / Latón / Messing / Ottone
MT109	2	ø0,50x80	Hilo marrón / Brown thread / Fil brun /braunes Baumwollfaden / Filo marrone
MT110	2	ø0,50x110	Hilo marrón / Brown thread / Fil brun /braunes Baumwollfaden / Filo marrone
MT111	1	ø4x100	Tilo / Lime wood / Tilleul / Linde / Tiglio
MT112	2	ø0,50x40	Latón / Brass / Latón / Messing / Ottone
MT113	2	ø0,50x100	Hilo marrón / Brown thread / Fil brun /braunes Baumwollfaden / Filo marrone
MT114	1	ø4x75	Tilo / Lime wood / Tilleul / Linde / Tiglio
MT115	2	ø0,50x35	Latón / Brass / Latón / Messing / Ottone
MT116	2	ø0,50x90	Hilo marrón / Brown thread / Fil brun /braunes Baumwollfaden / Filo marrone
MT117	1	ø5x155	Tilo / Lime wood / Tilleul / Linde / Tiglio
MT118	2	11x14	Metal / Metal / Metal / Metall / Metallo
MT119	1	ø4x110	Tilo / Lime wood / Tilleul / Linde / Tiglio
MT120	2	ø0,50X75	Hilo marrón / Brown thread / Fil brun /braunes Baumwollfaden / Filo marrone

Lista de piezas / Parts List / Liste des pièces / Teileliste / Elenco delle parti

Nº/No./ N° / Nr. / No	Descripción / Description /Description / Beschreibung / Descrizione	Cantidad / Quantity / Quantité / Menge / Quantità	Medidas / Measurements / Dimensions /Maße / Misure	Material / Material / Matériau / Material / Materiale
A		1200	10	Metal / Metal / Metal / Metall / Metallo
B		550	15	Latón / Brass / Latón / Messing / Ottone
C		335	ø0,15x100	Hilo crudo / Raw thread / Fil brut / Rohes Baumwollfaden / Filo crudo
D		230	4	Madera / Wood / Bois / Holz / Legno
E		105	4	Madera / Wood / Bois / Holz / Legno
H		60	ø3	Latón / Brass / Latón / Messing / Ottone
J		70	10	Madera / Wood / Bois / Holz / Legno



Accede a vídeos tutoriales fotografiando los códigos QR.
Access tutorial videos photographing QR codes.
Accédez aux didacticiels vidéo photographiant les codes QR.
Greifen Sie auf Video-Tutorials zu, die QR-Code fotografieren.
Accedi ai video tutorial fotografando i codici QR.
Доступ к видеоурокам фотографирования QR-кодов.

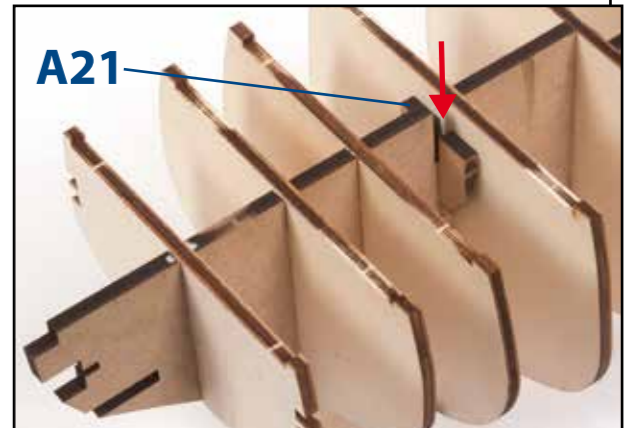
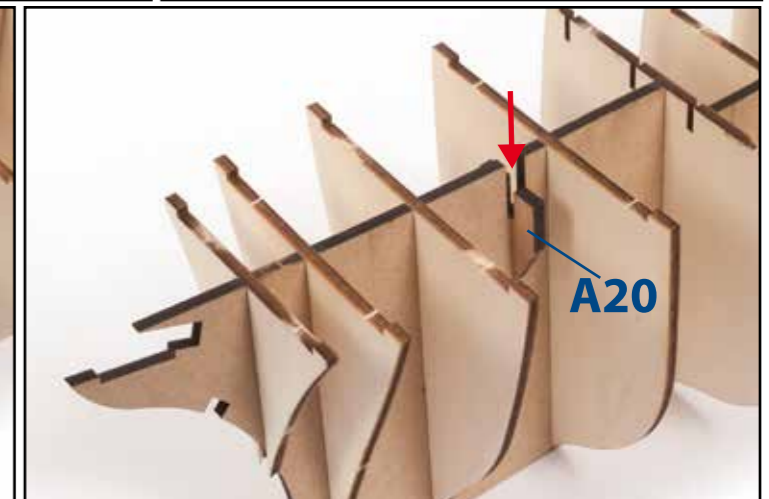
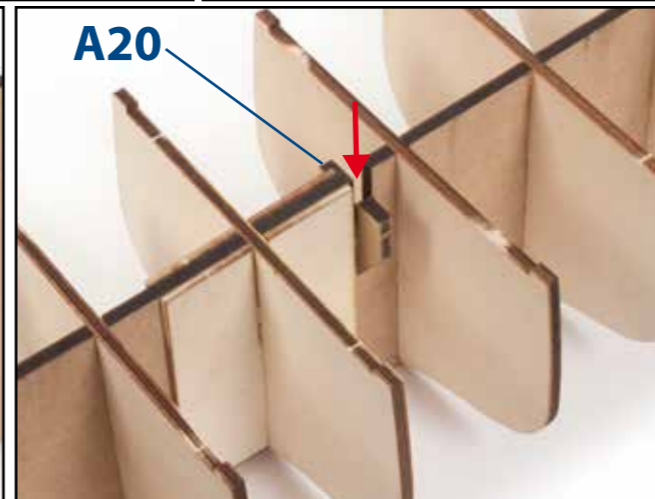
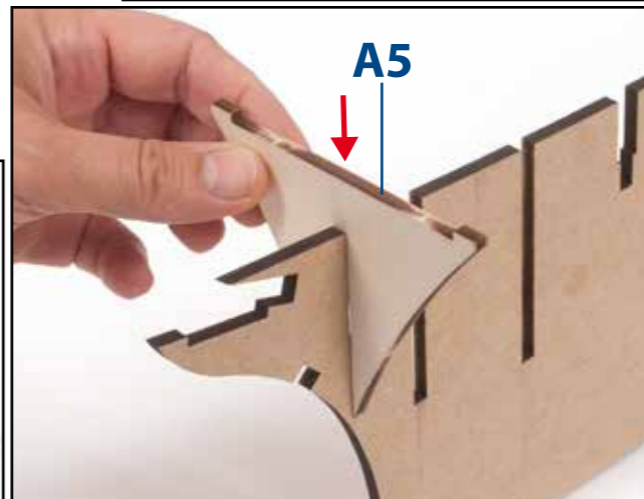
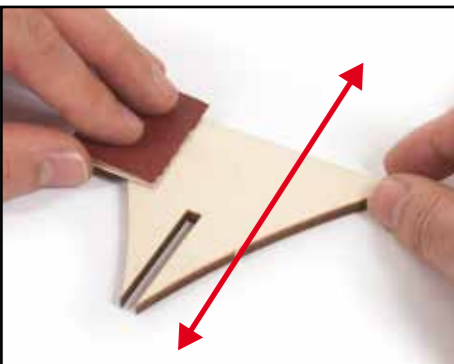
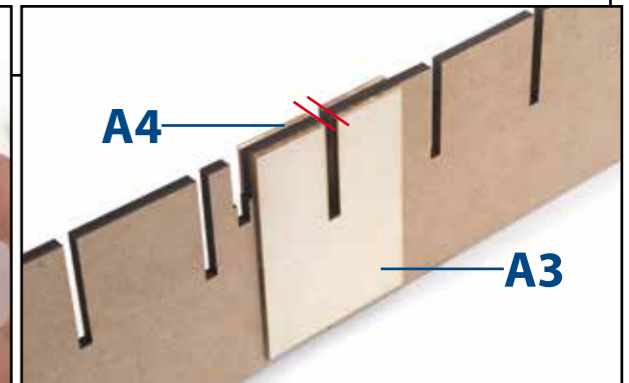
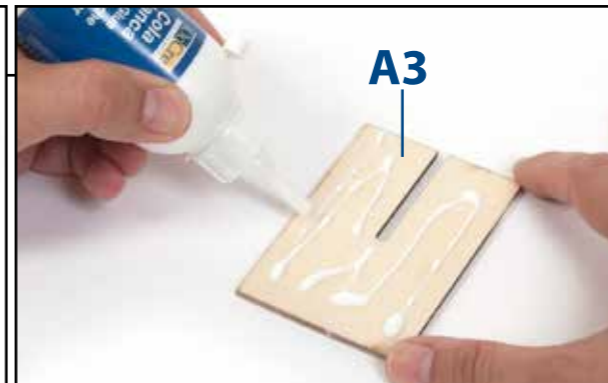
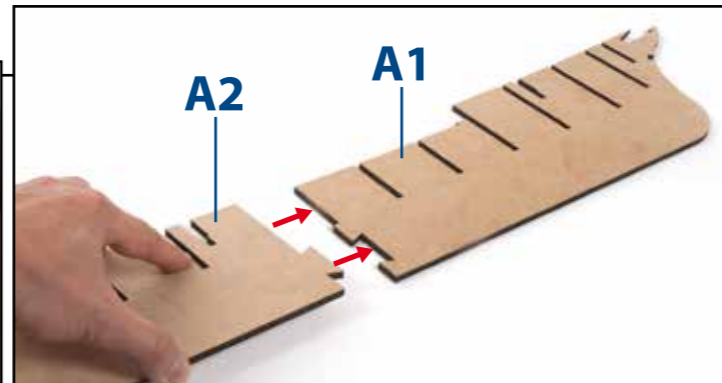
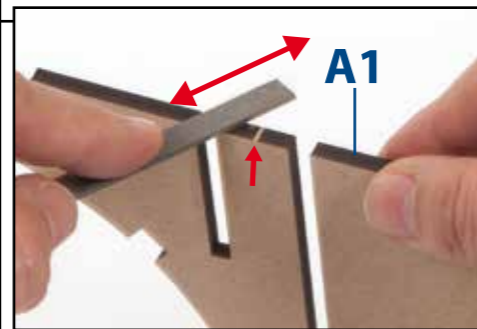
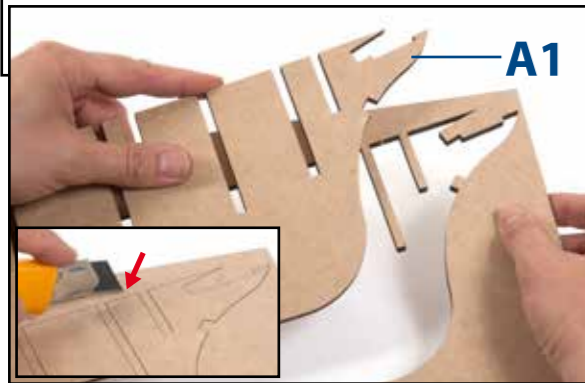
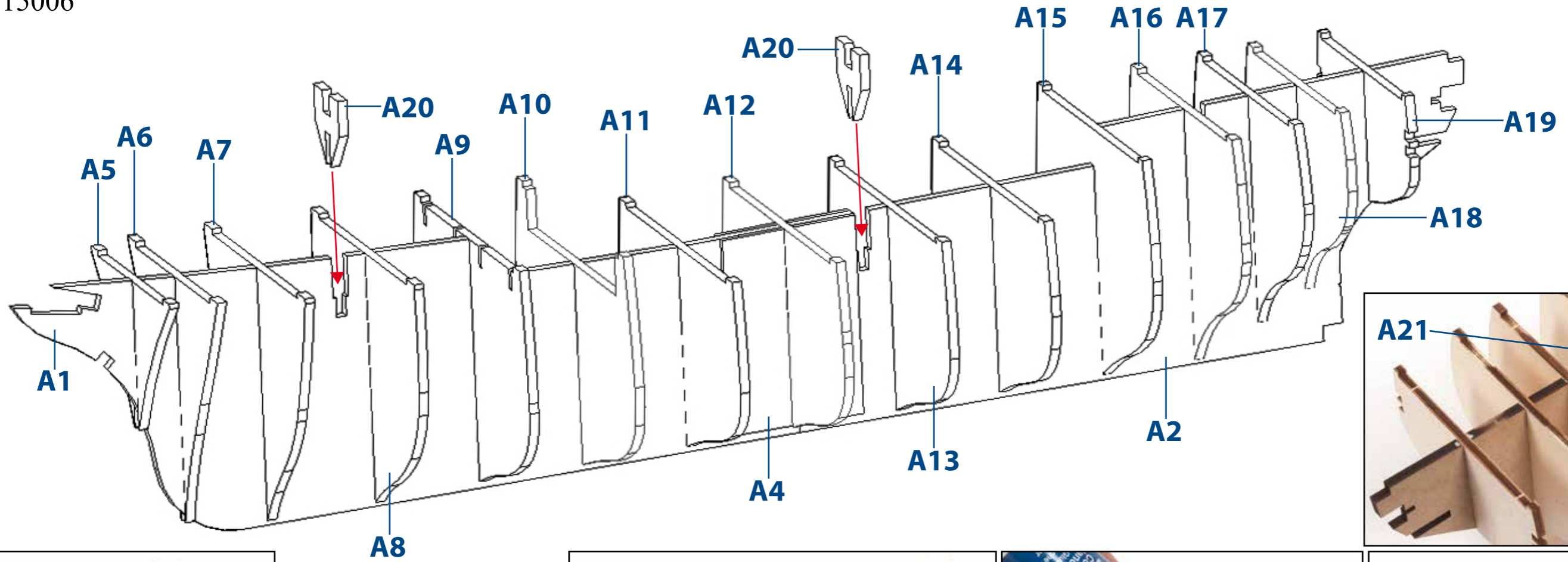

B

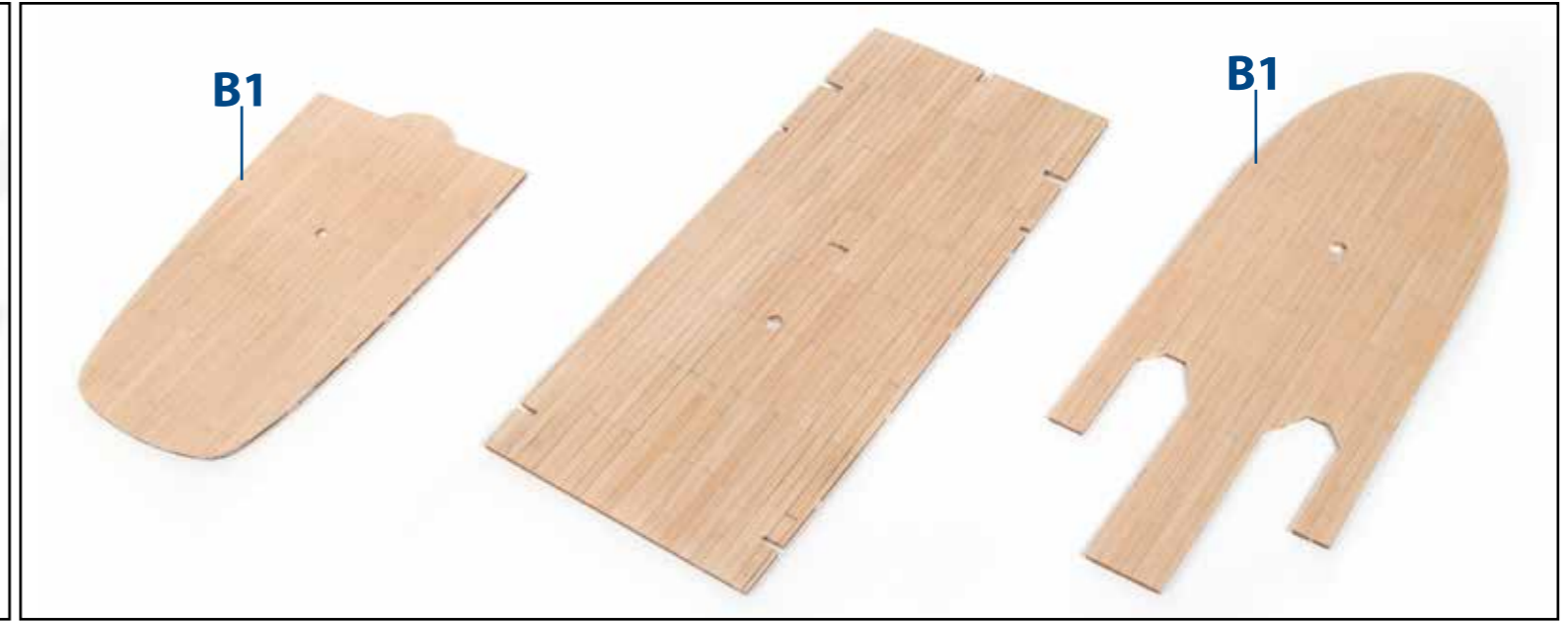
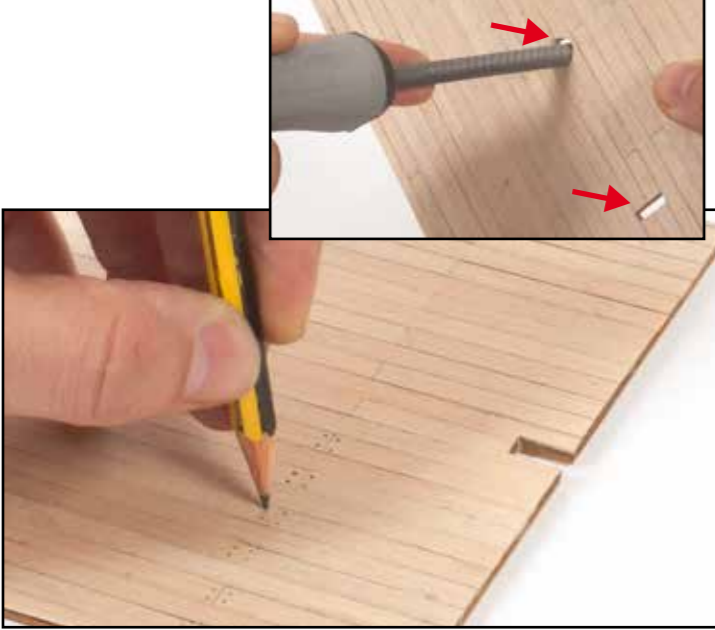
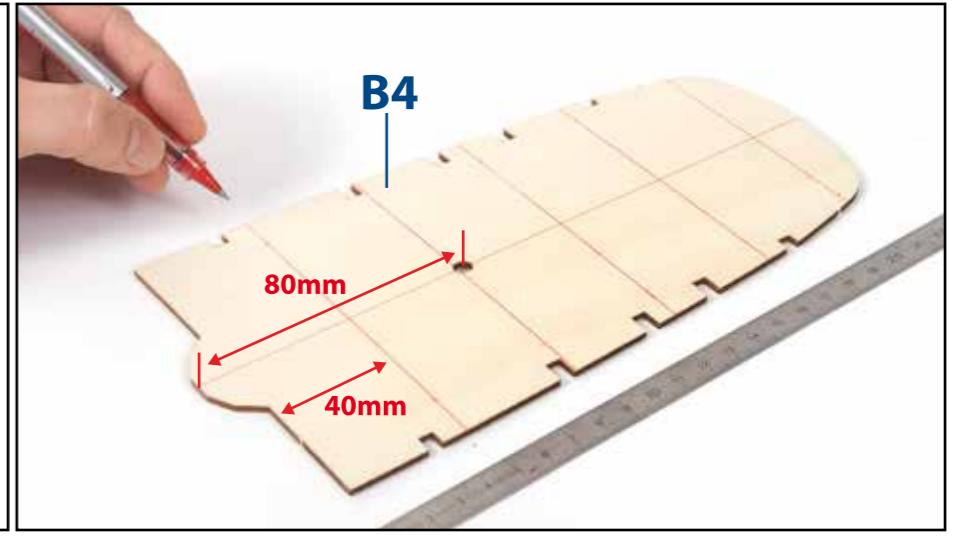
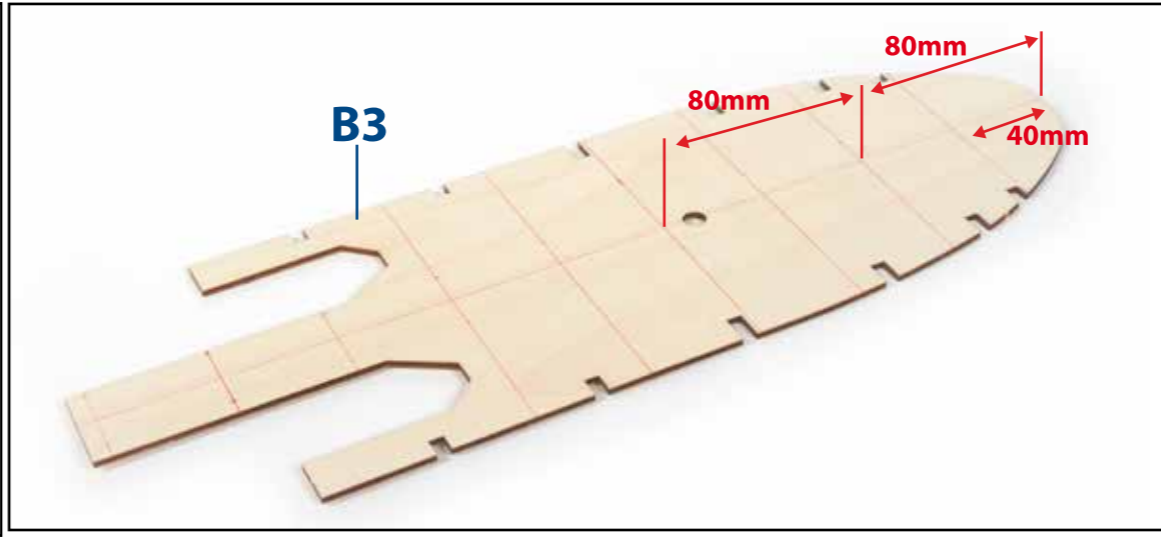
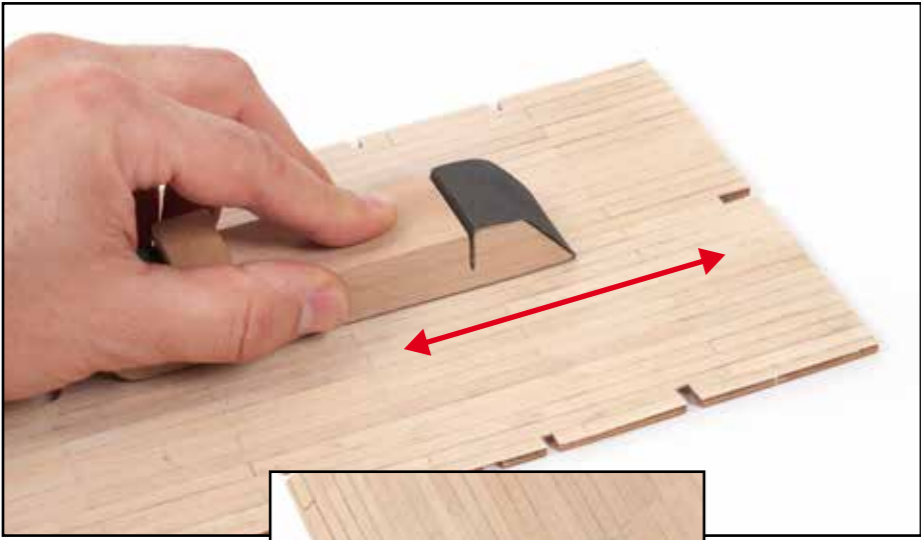
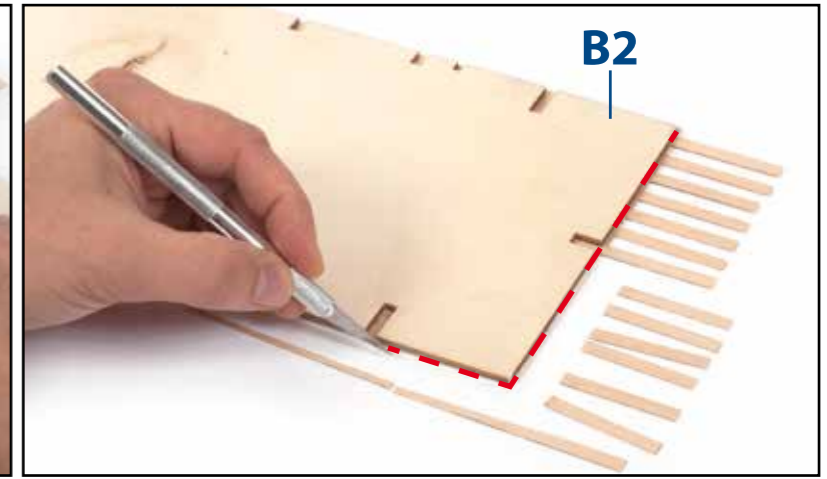
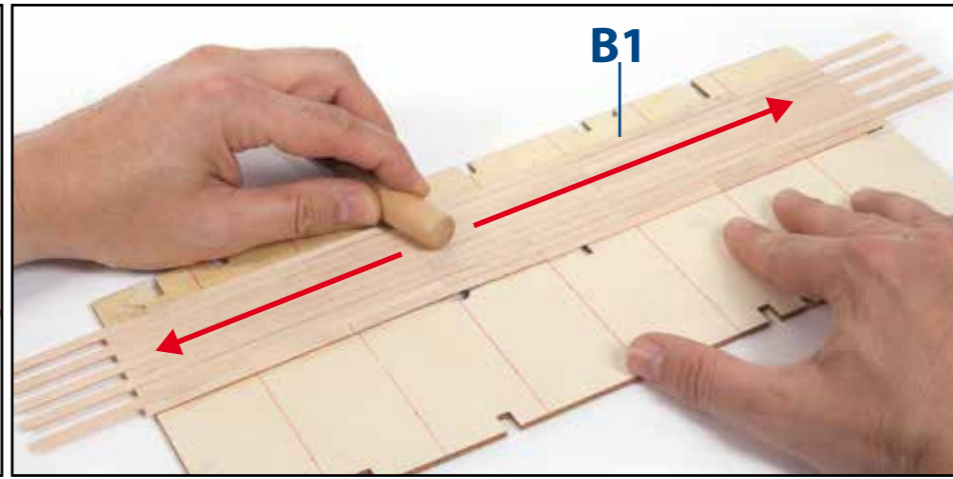
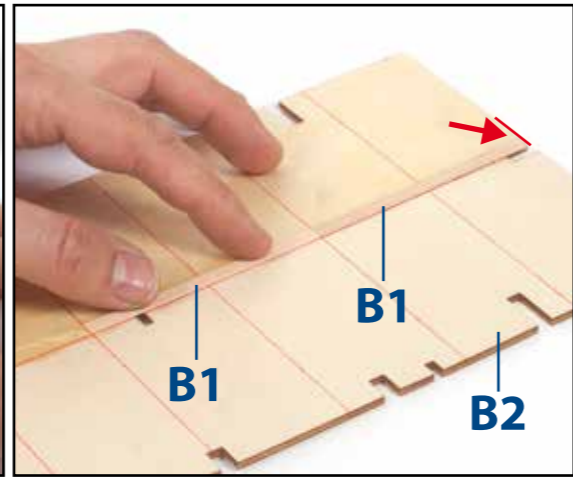
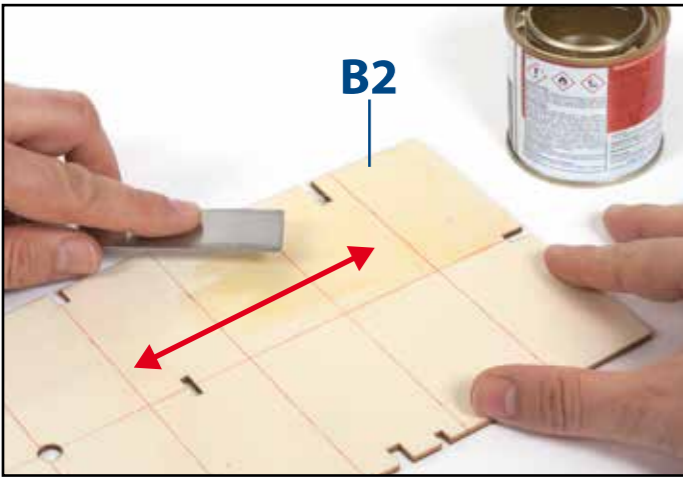
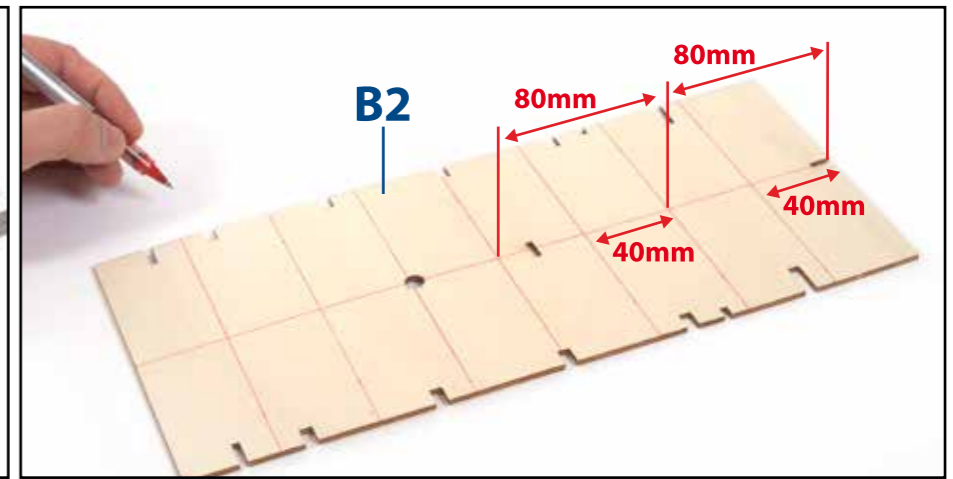
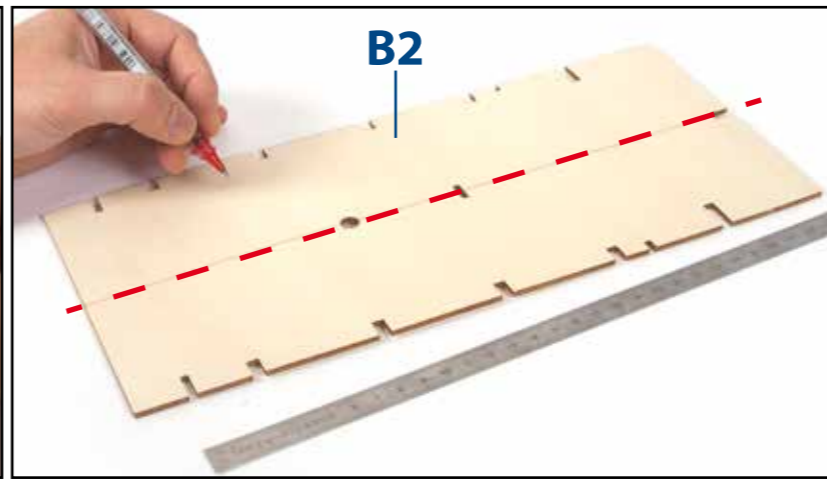
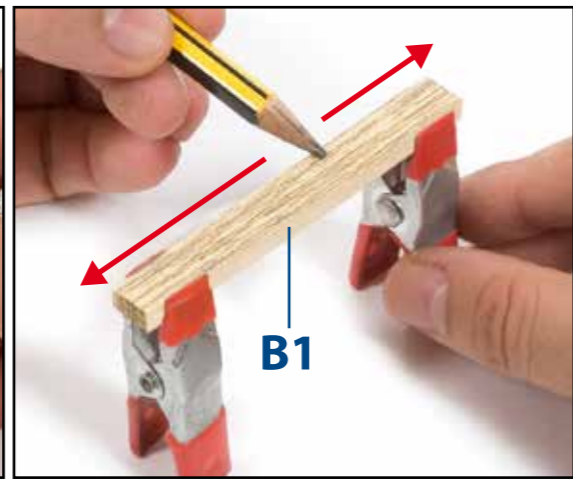
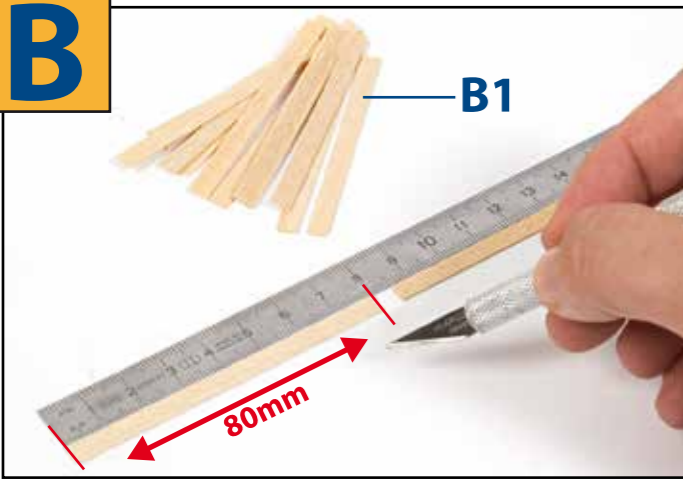

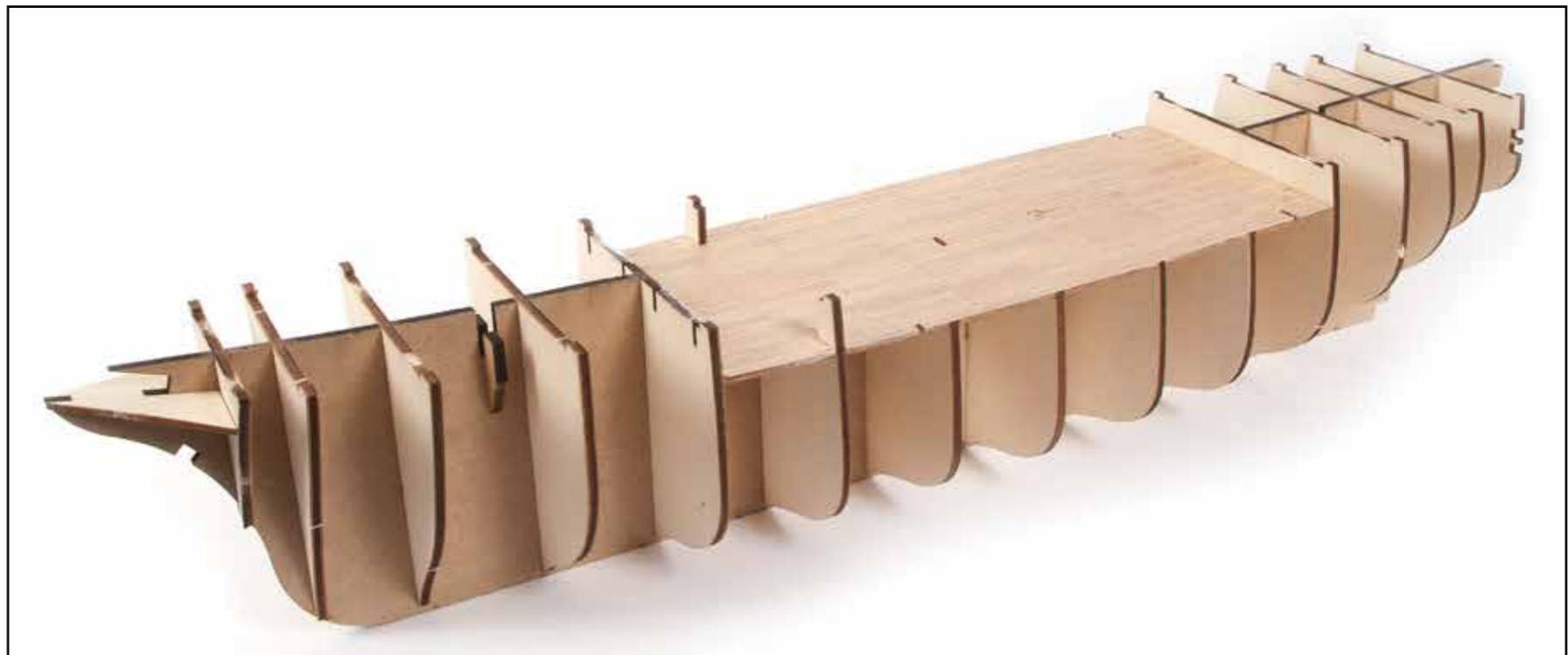
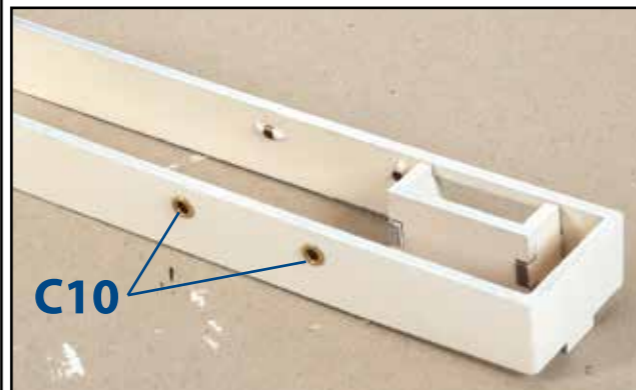
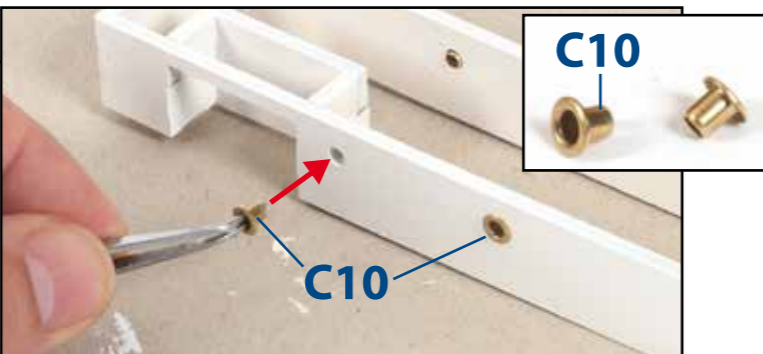
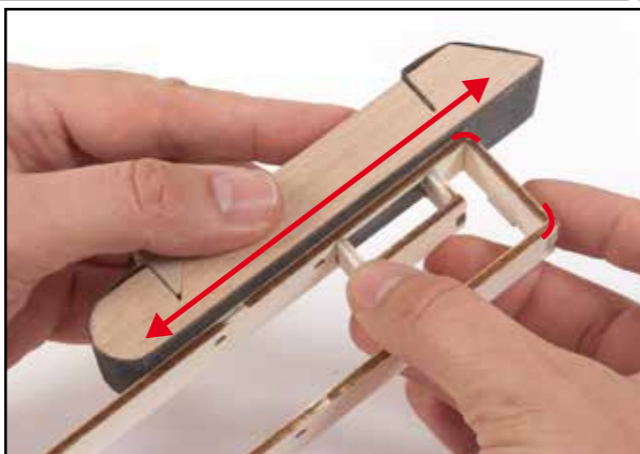
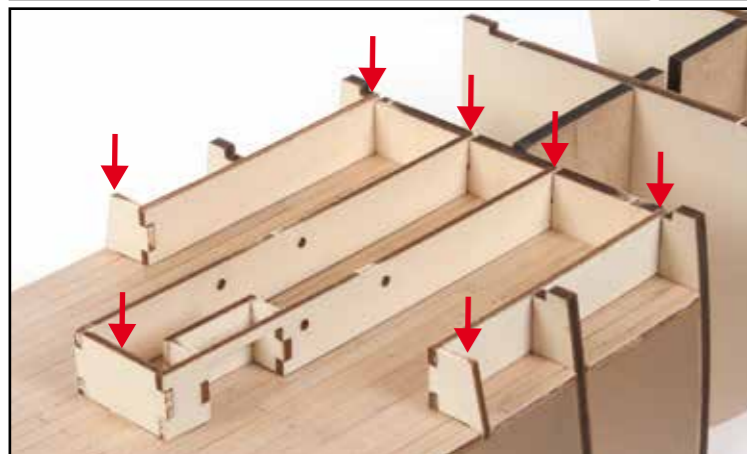
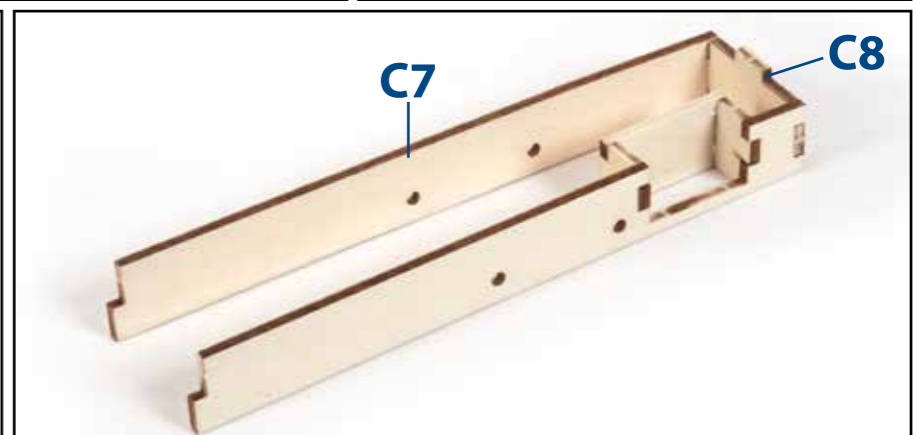
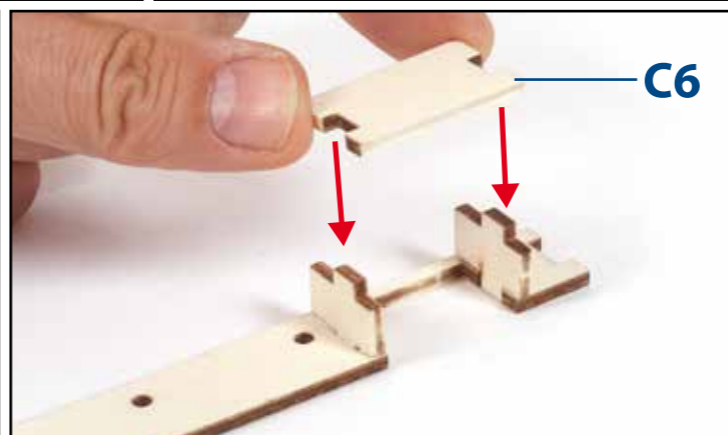
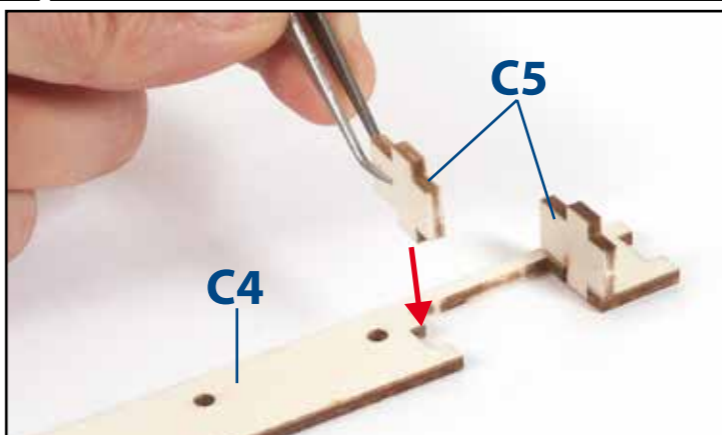
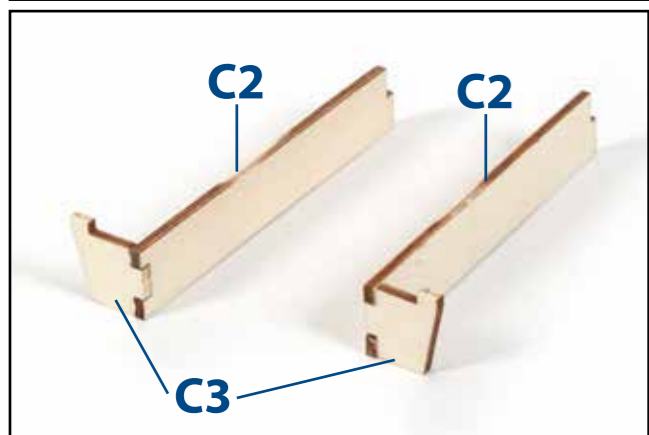
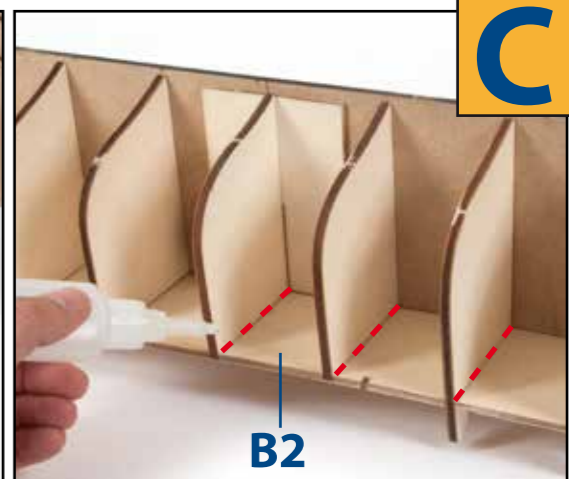
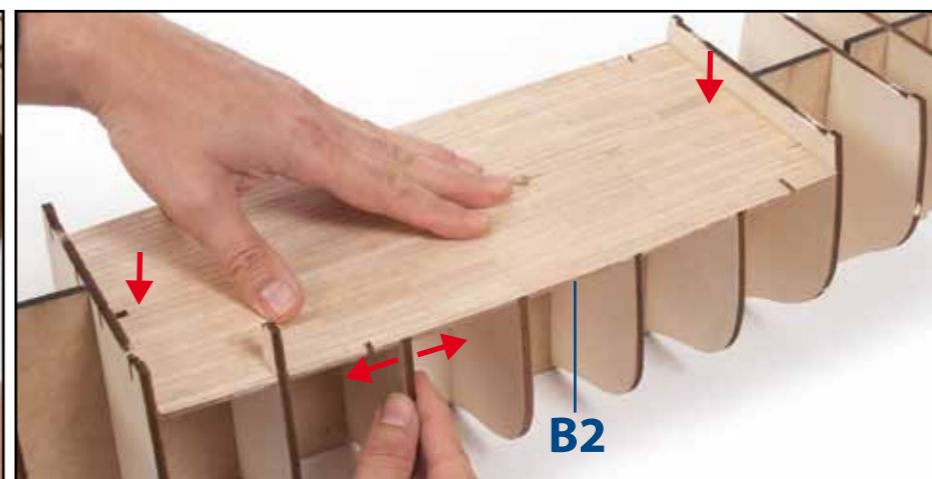
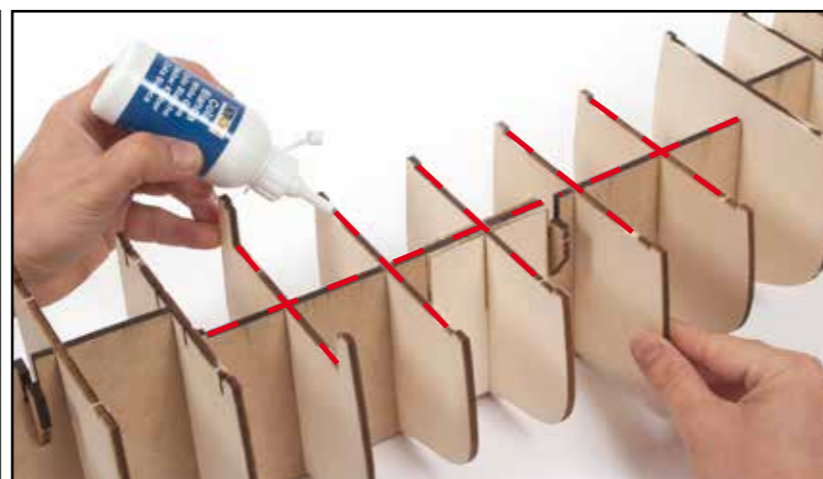
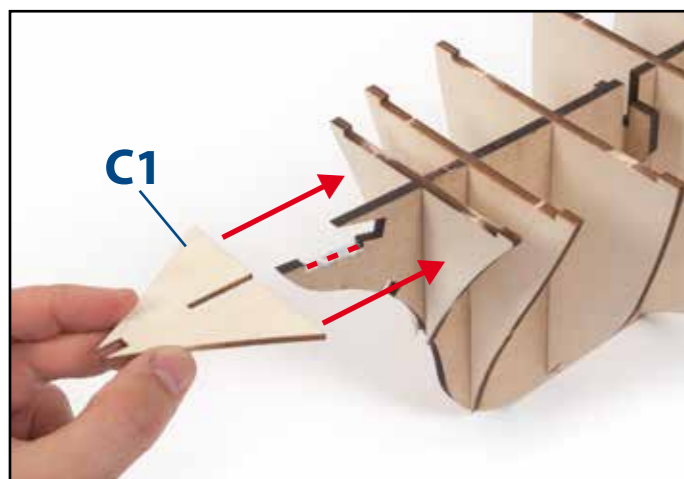

D

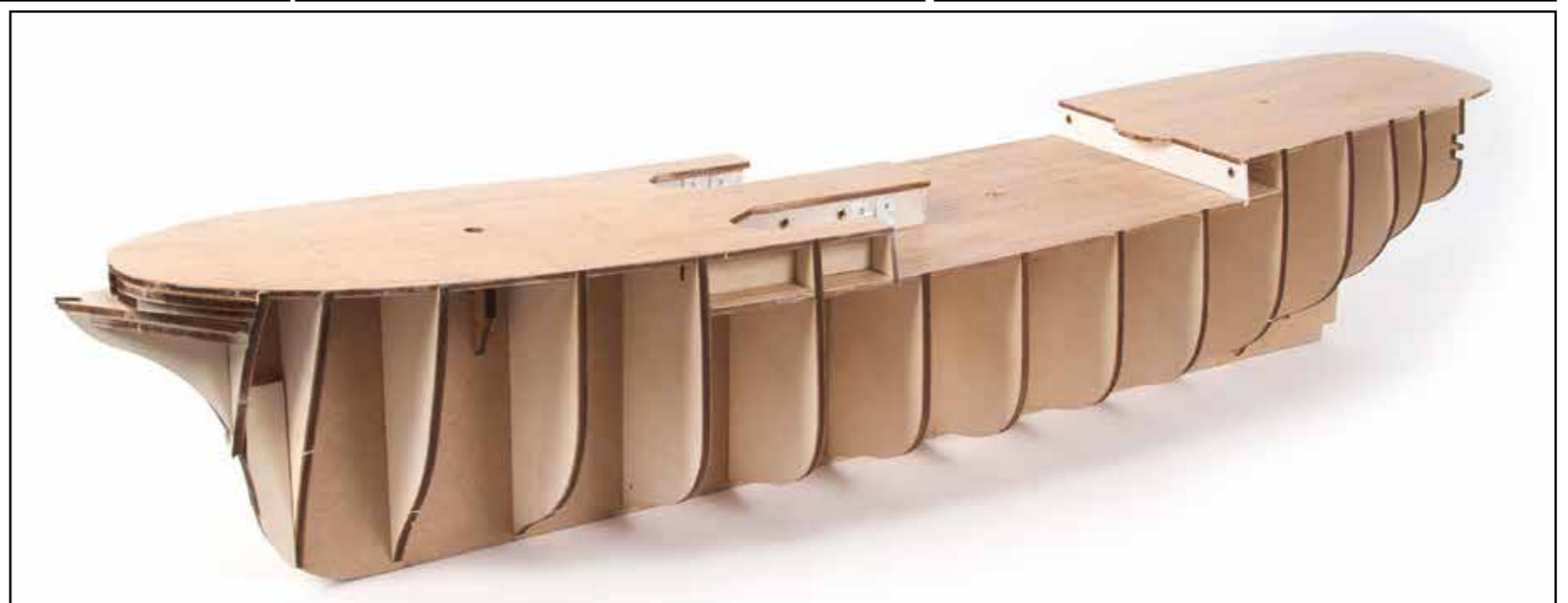
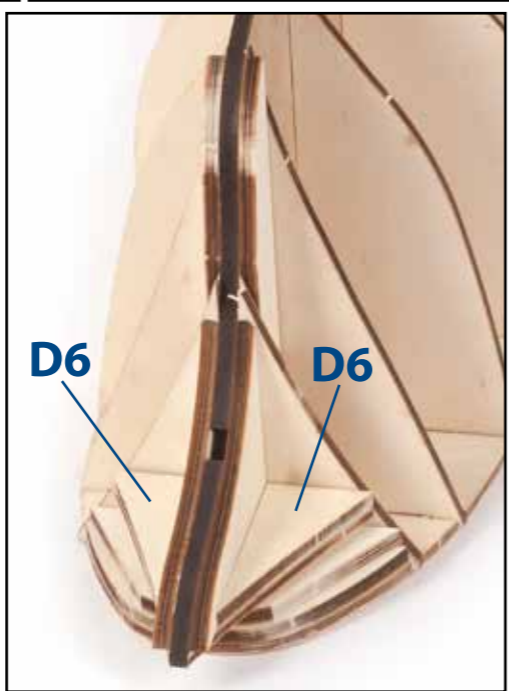
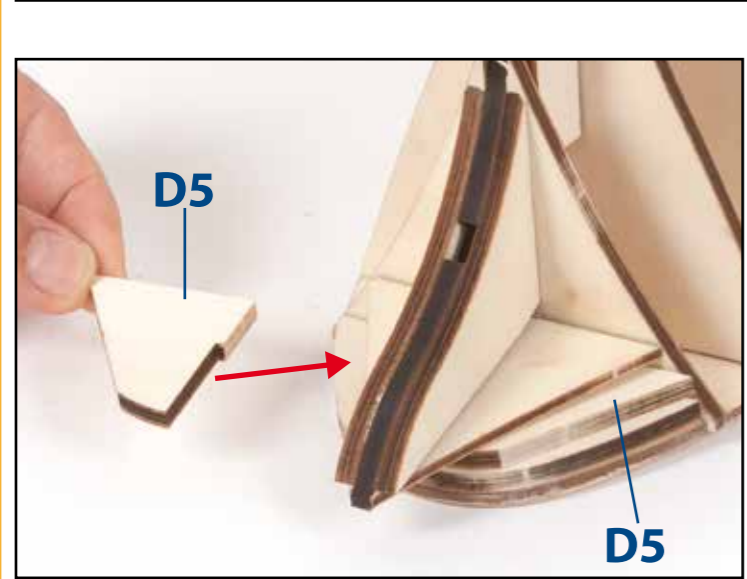
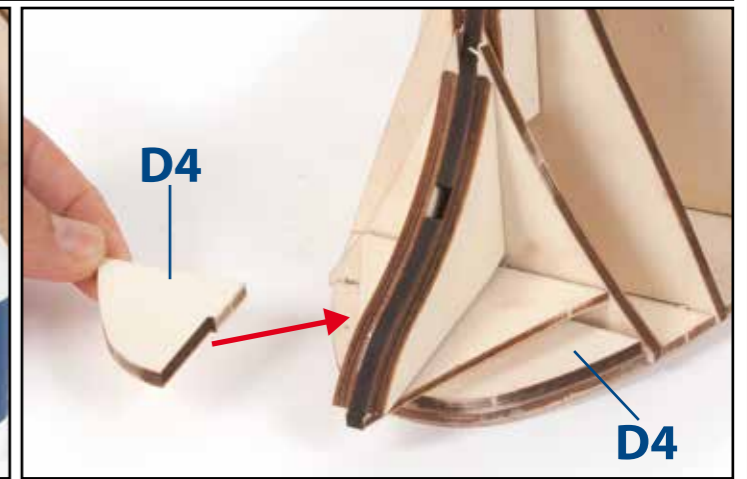
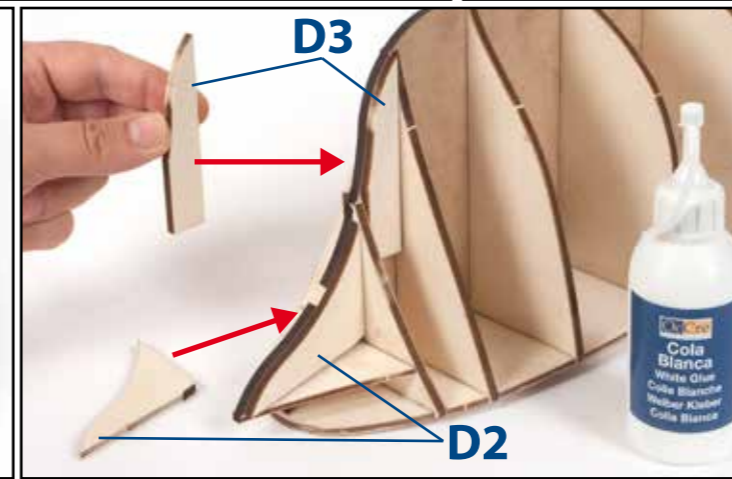
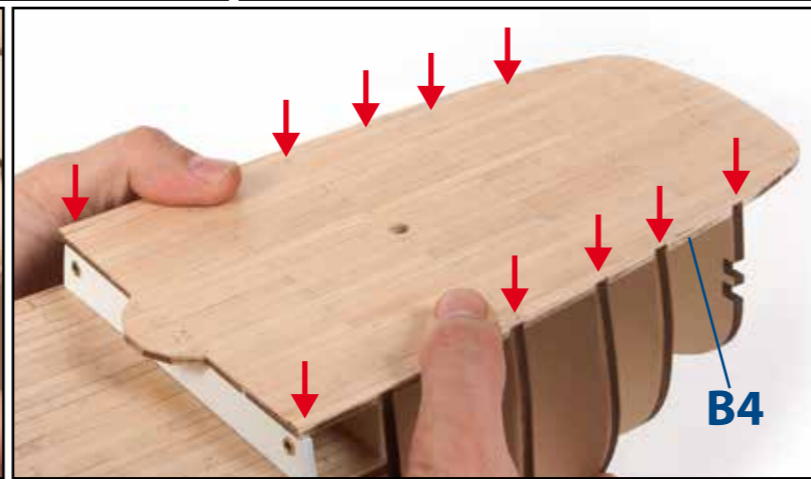
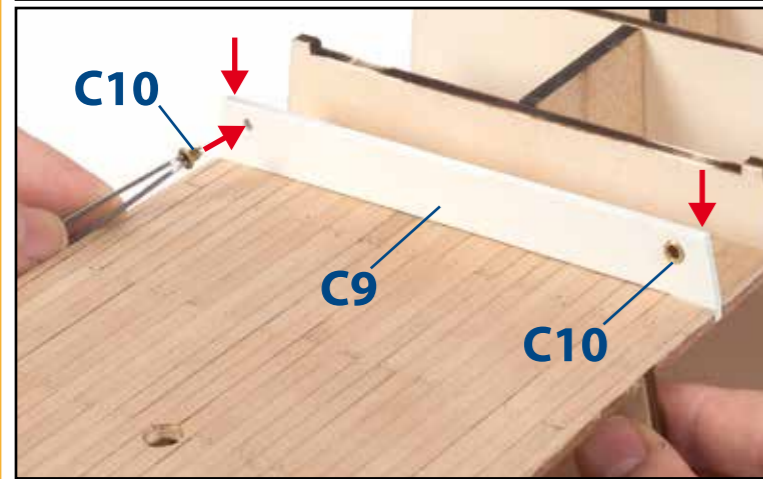
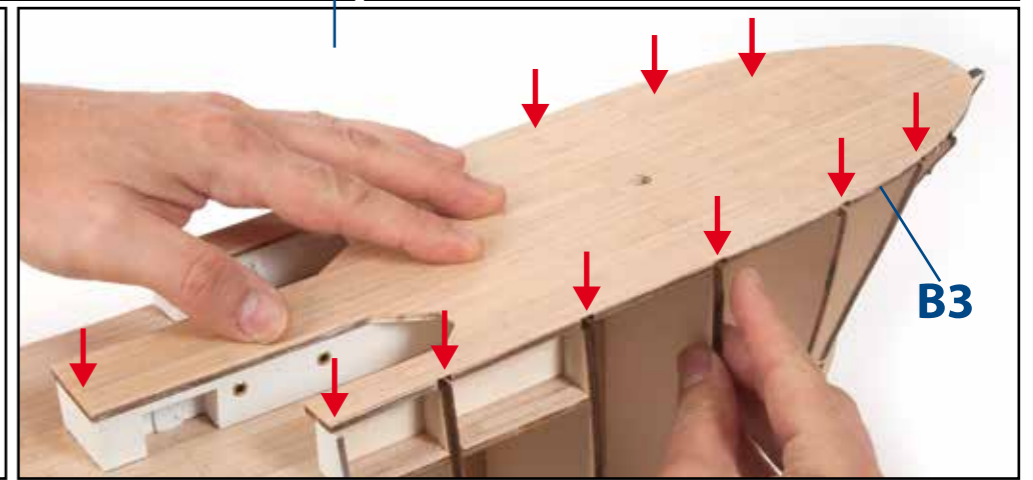
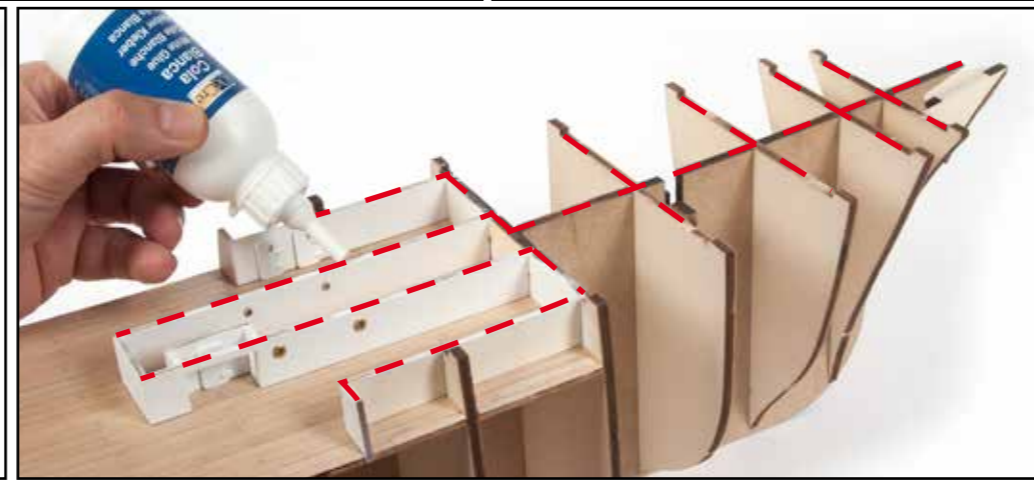
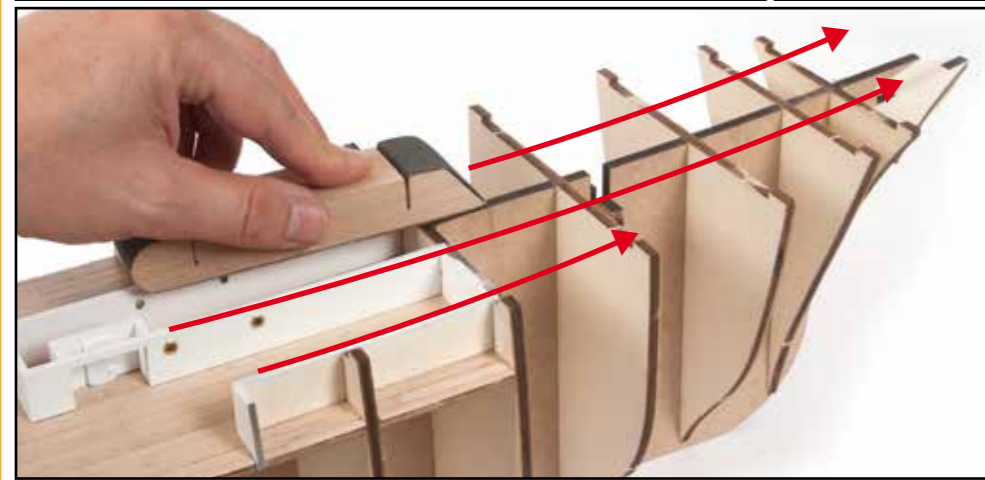
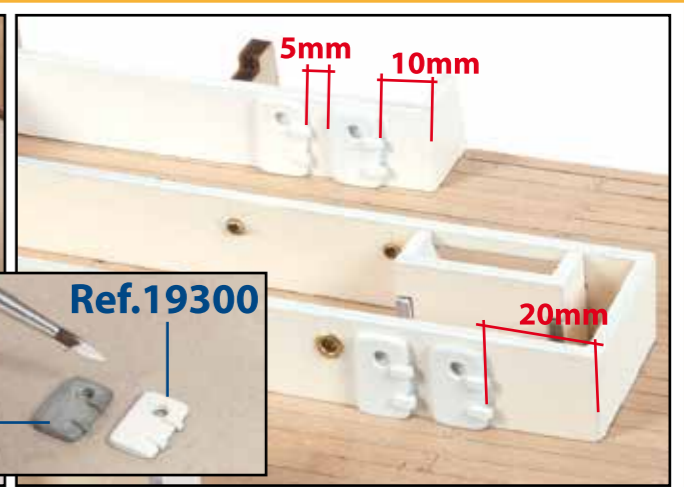
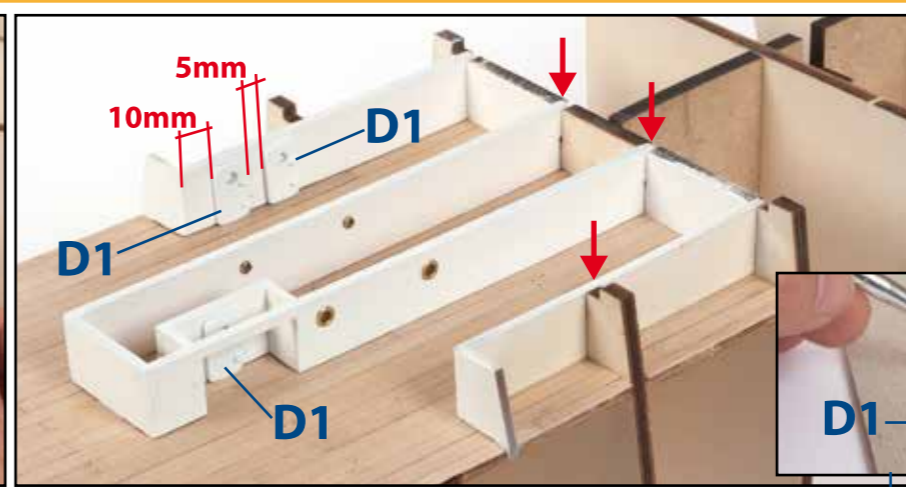
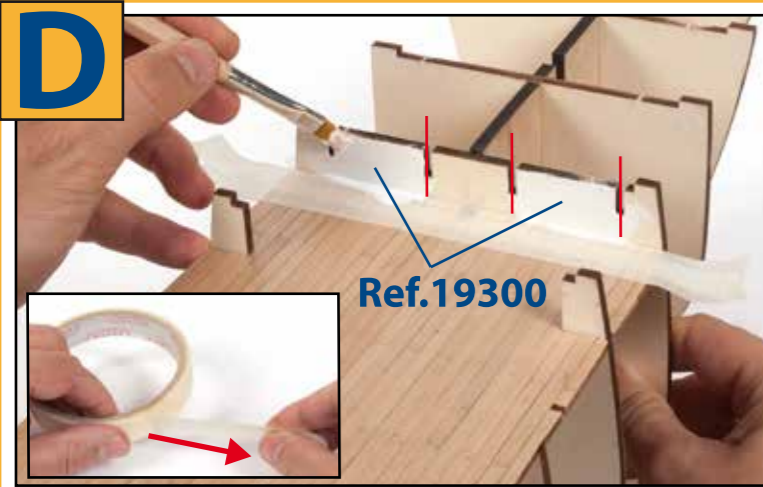

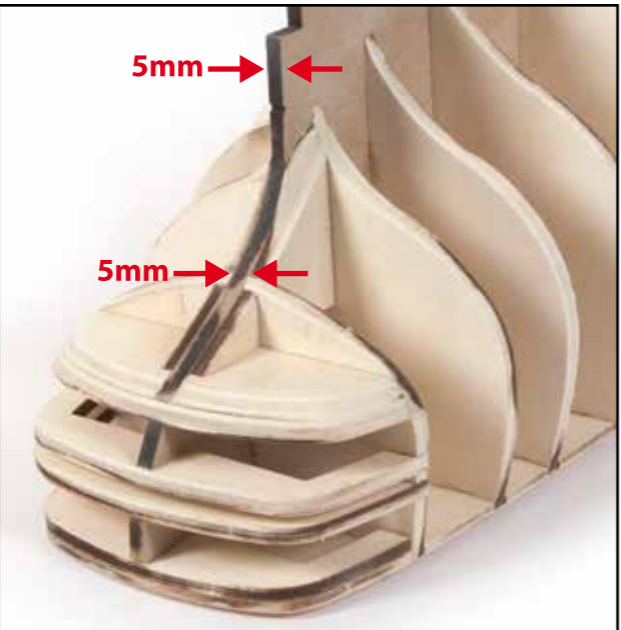
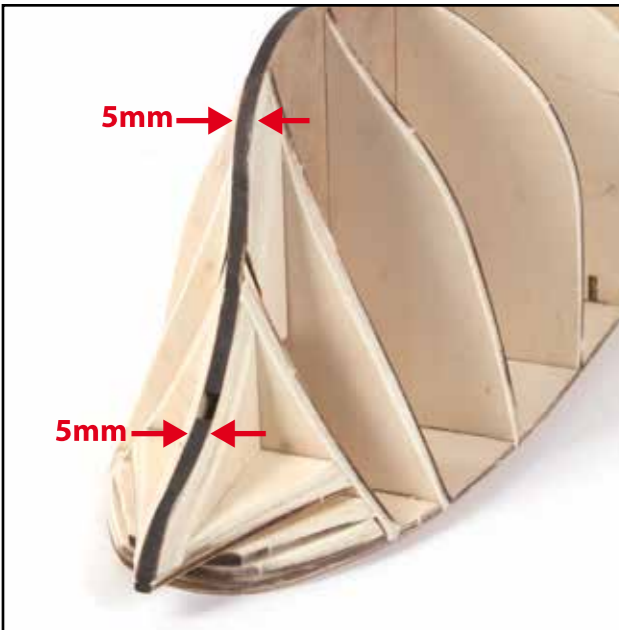
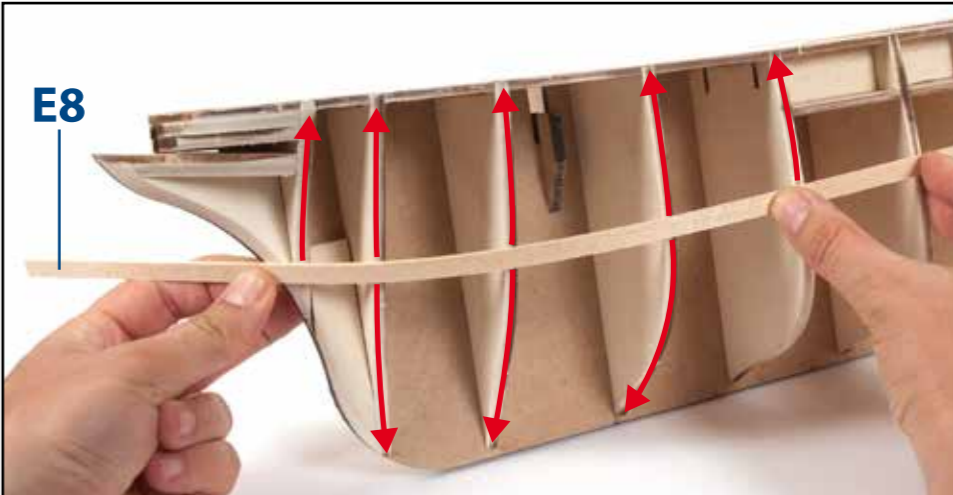
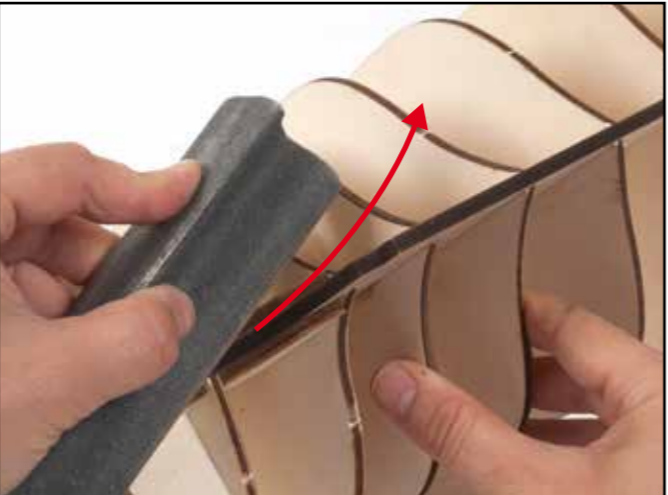
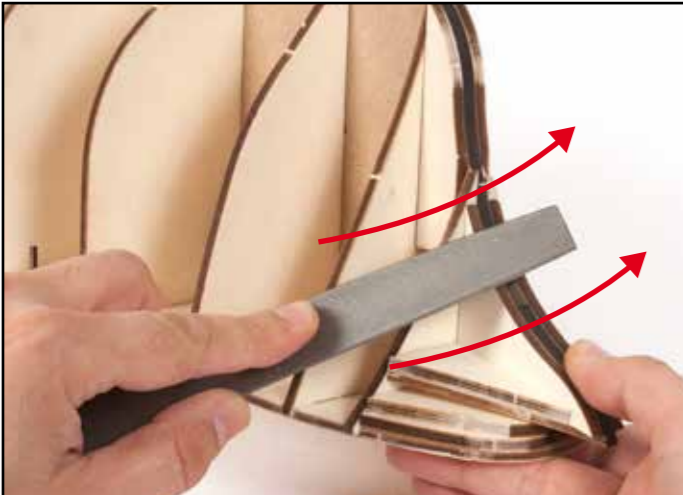
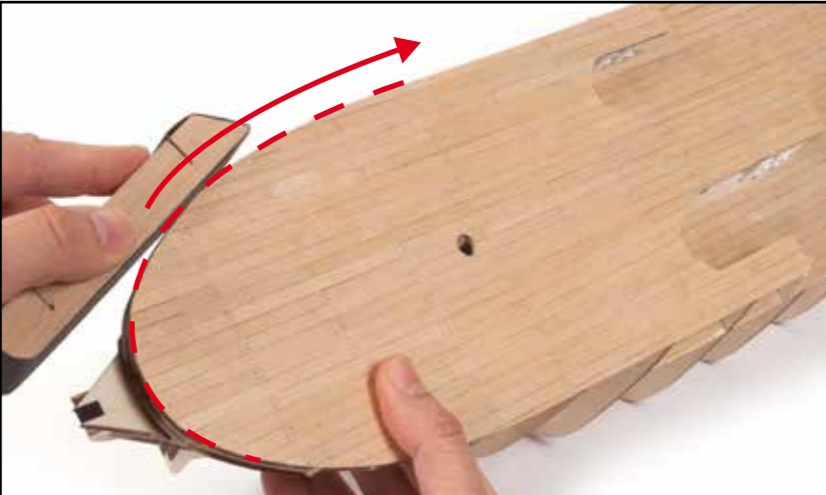
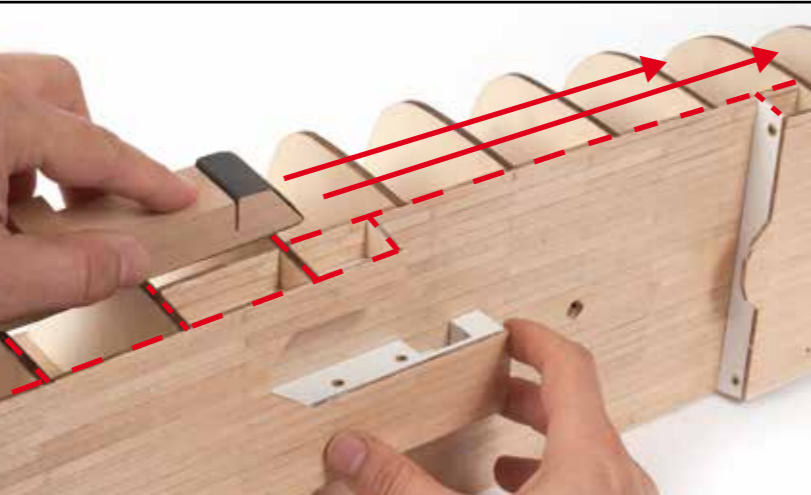
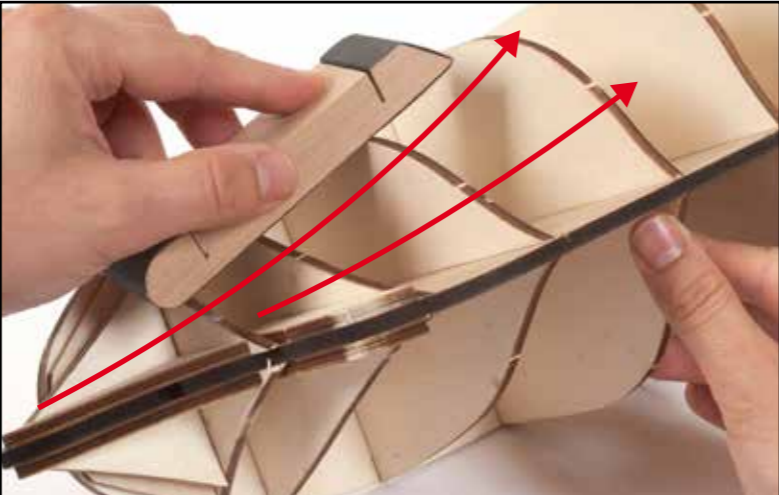
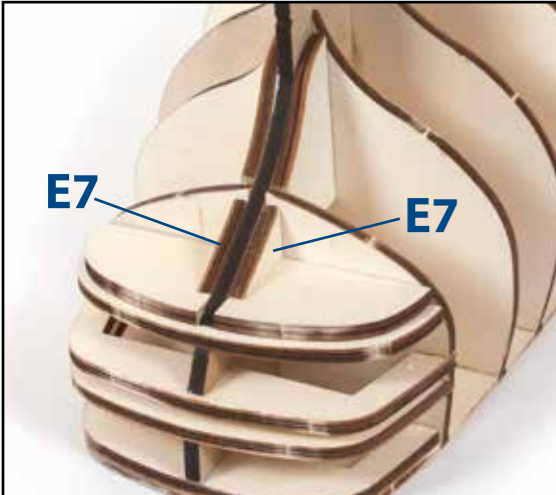
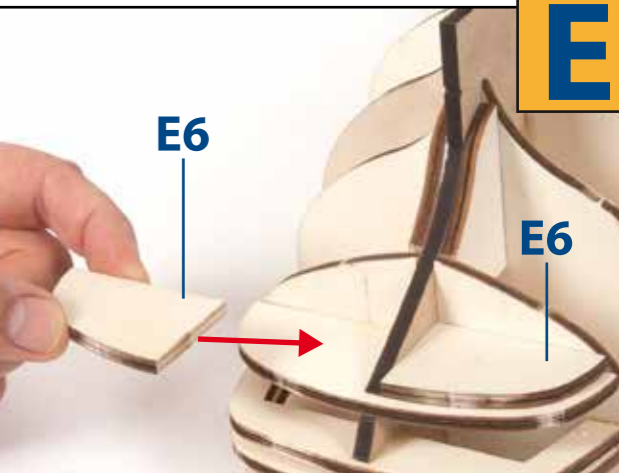
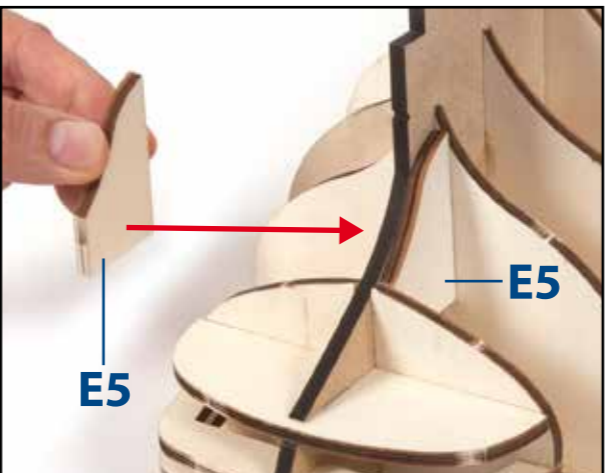
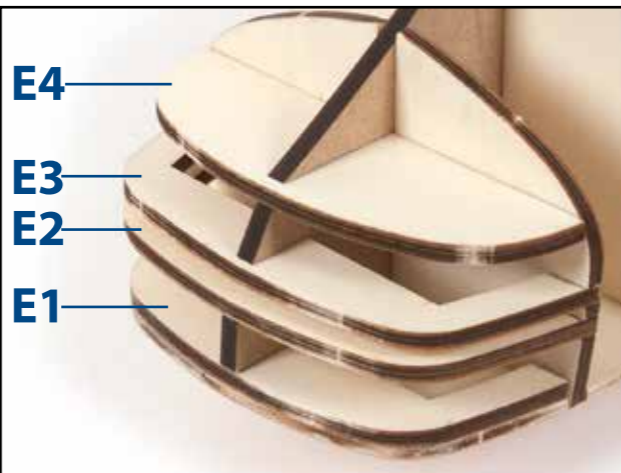
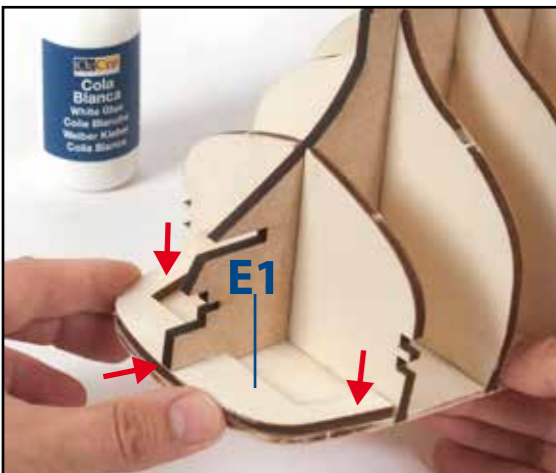

F

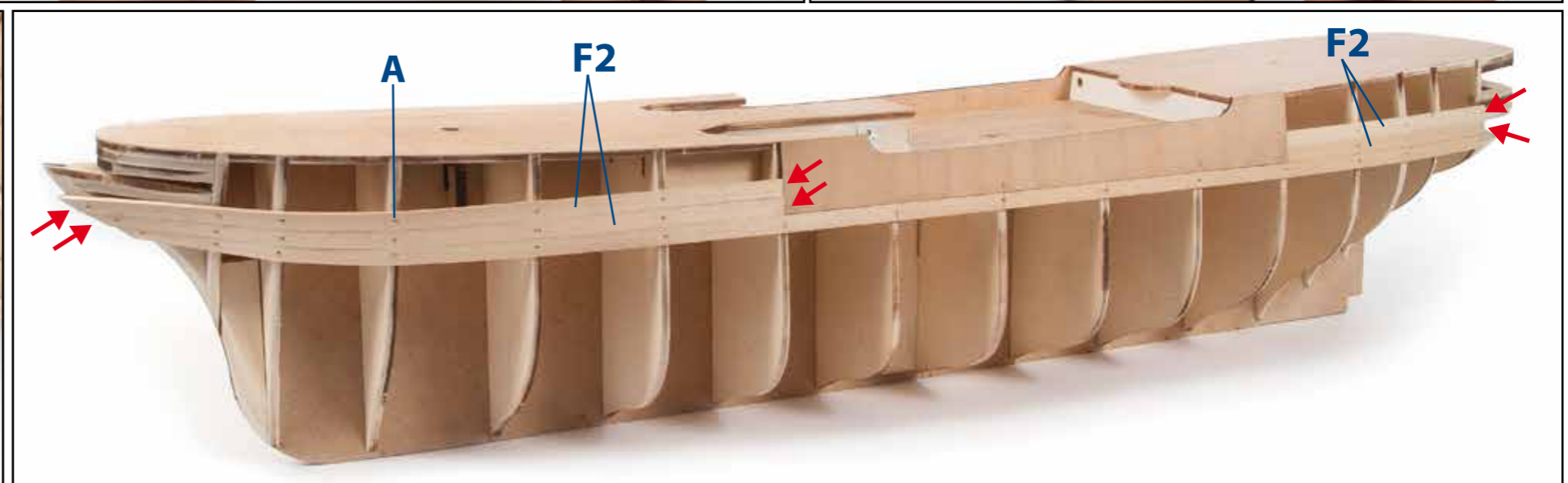
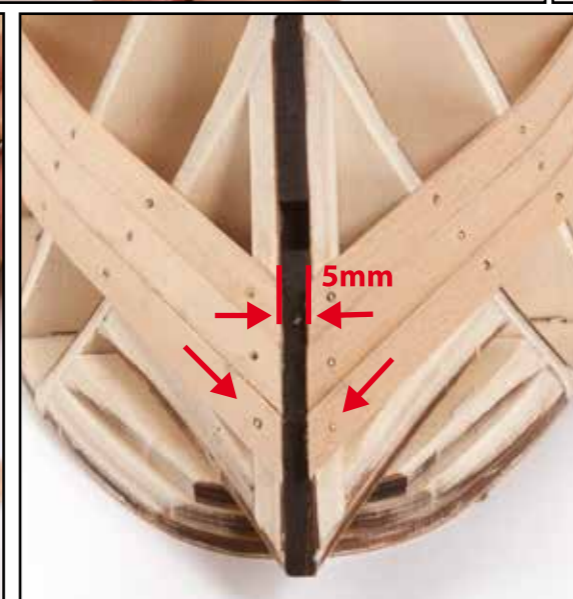
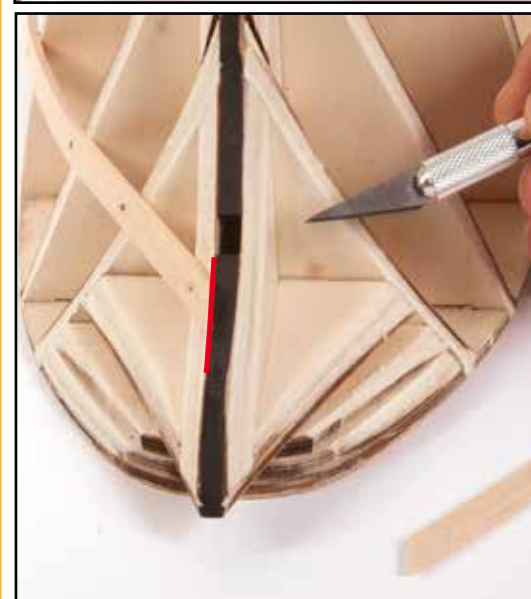
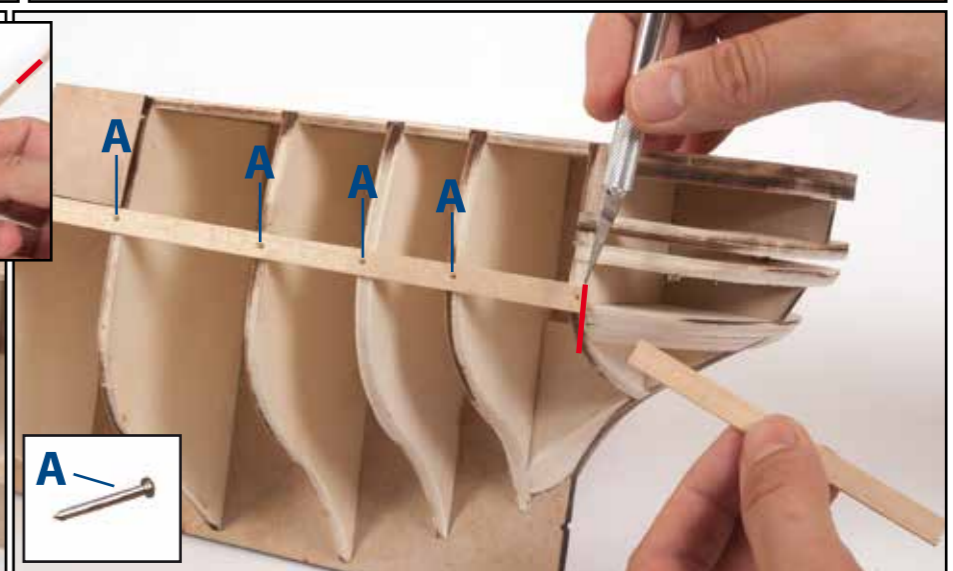
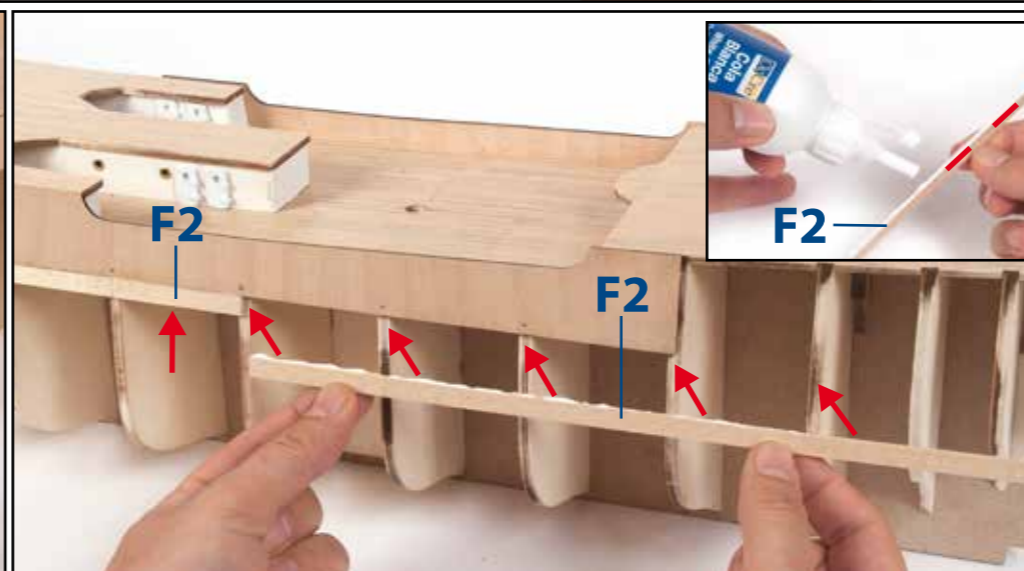
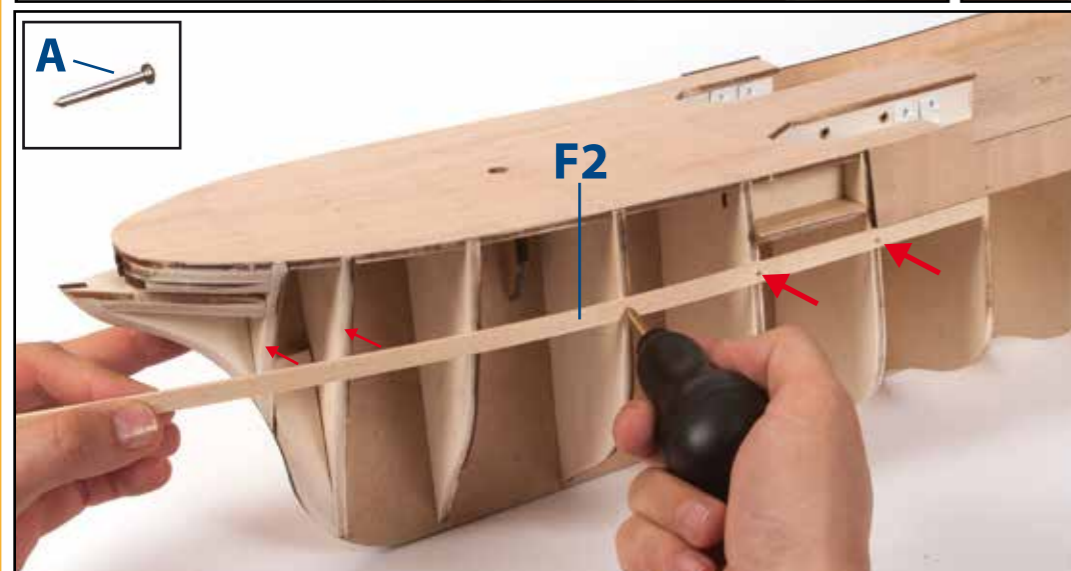
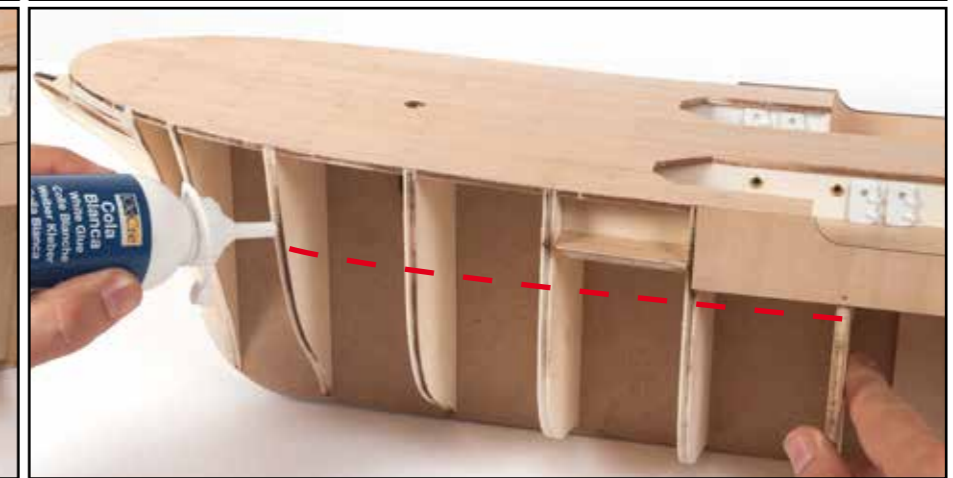
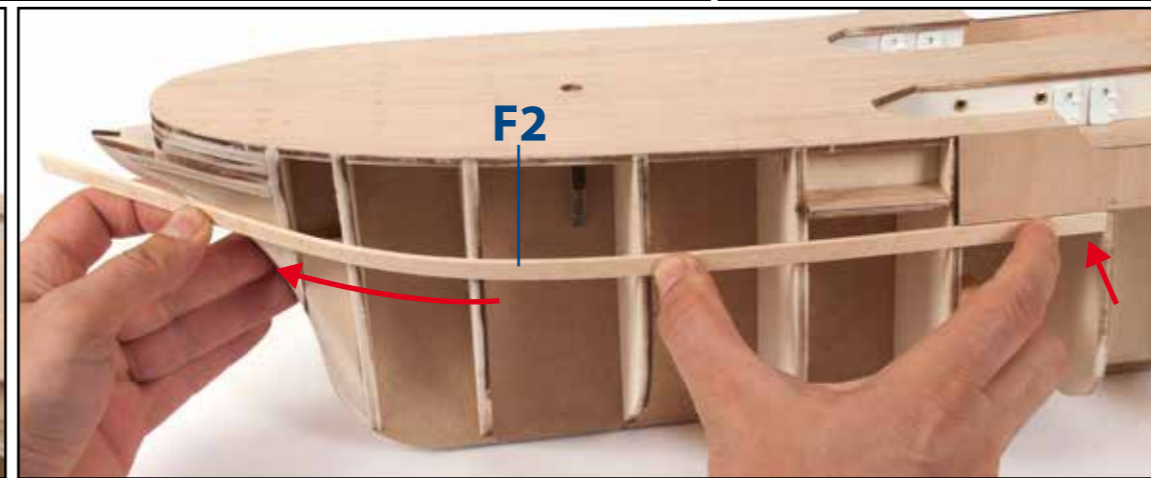
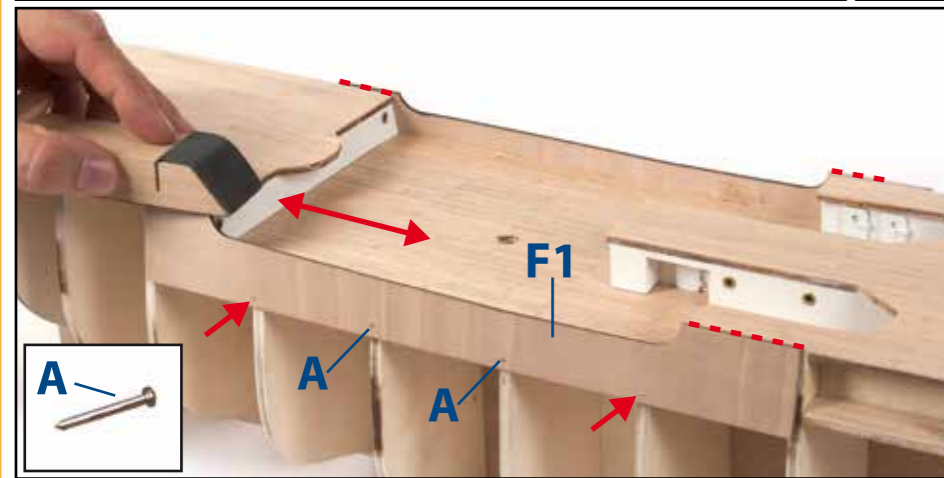
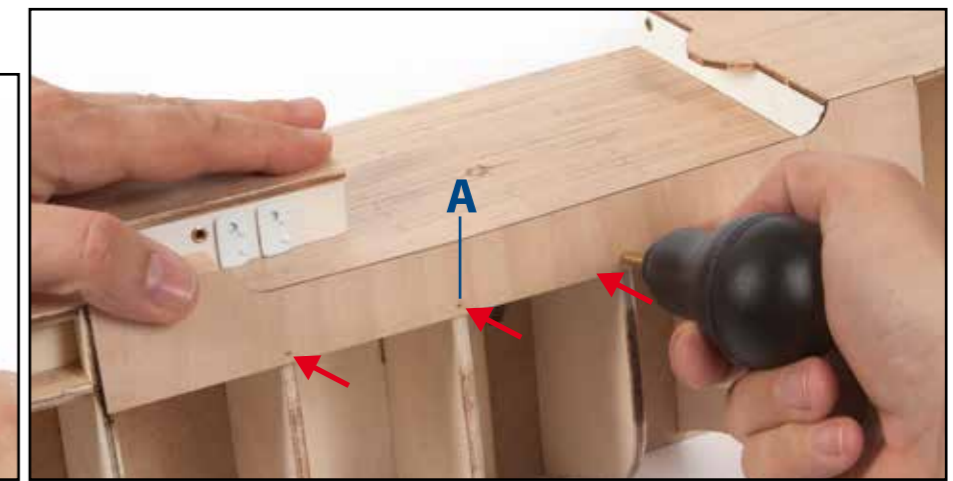
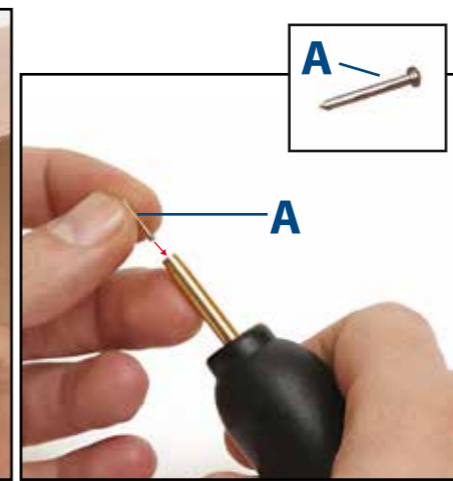
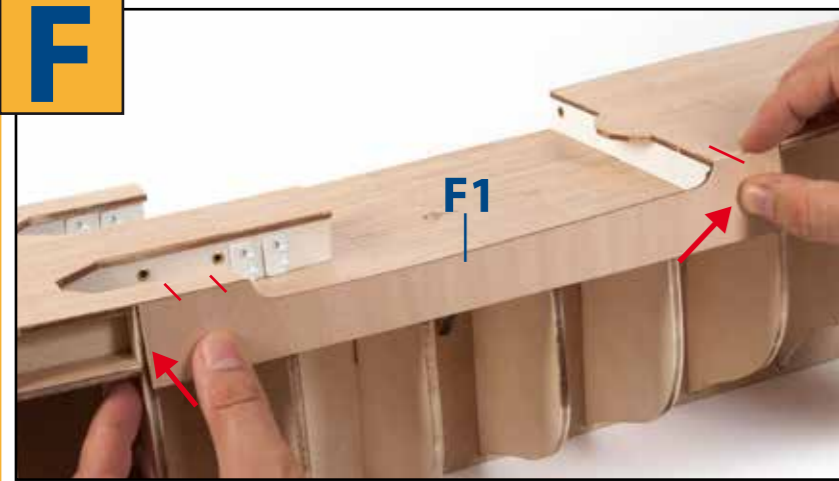

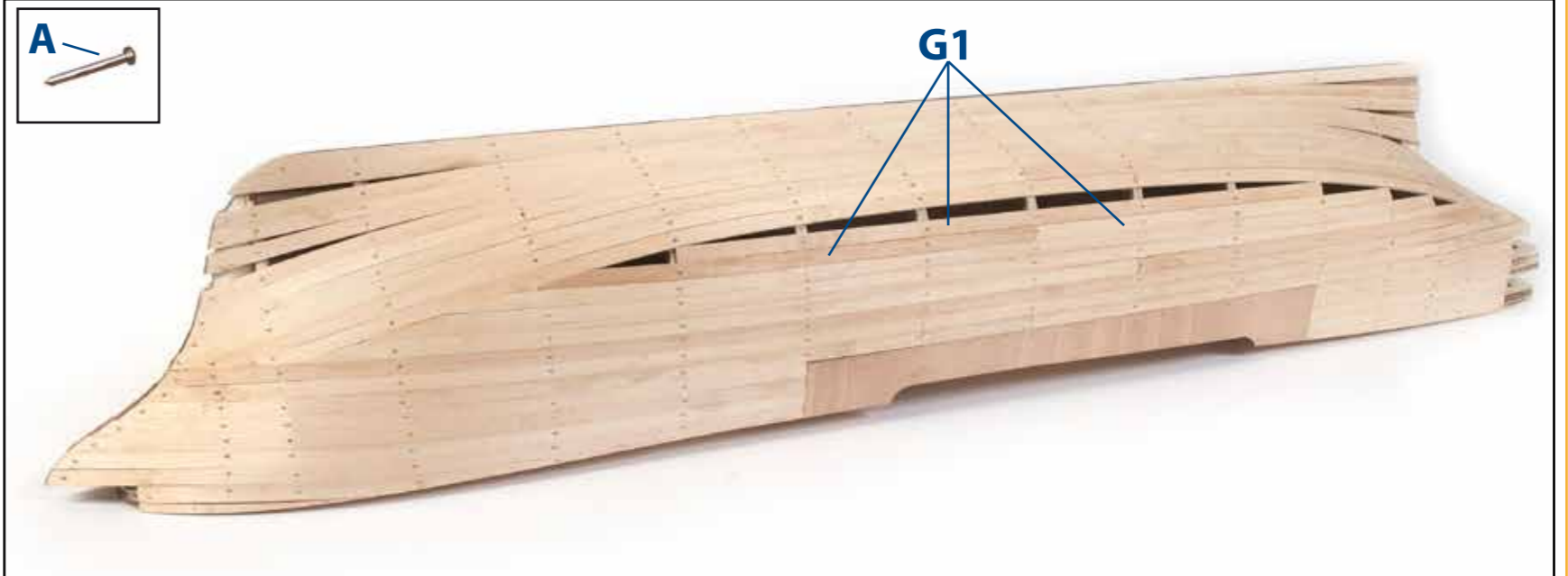
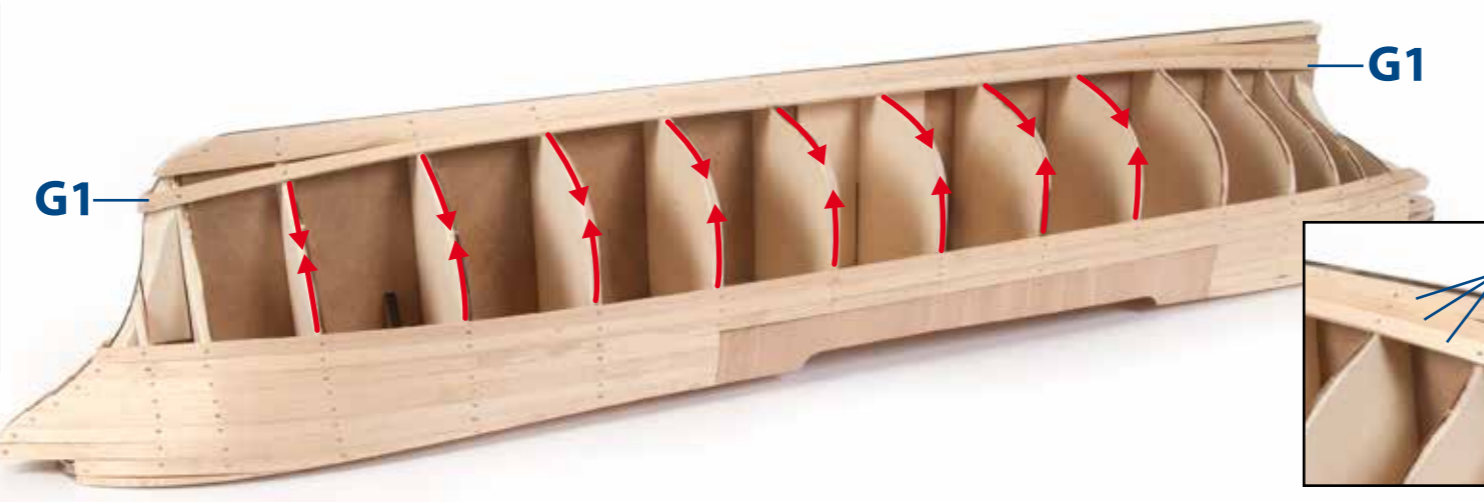
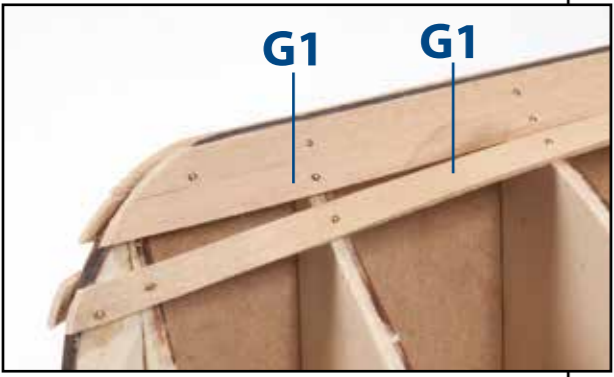
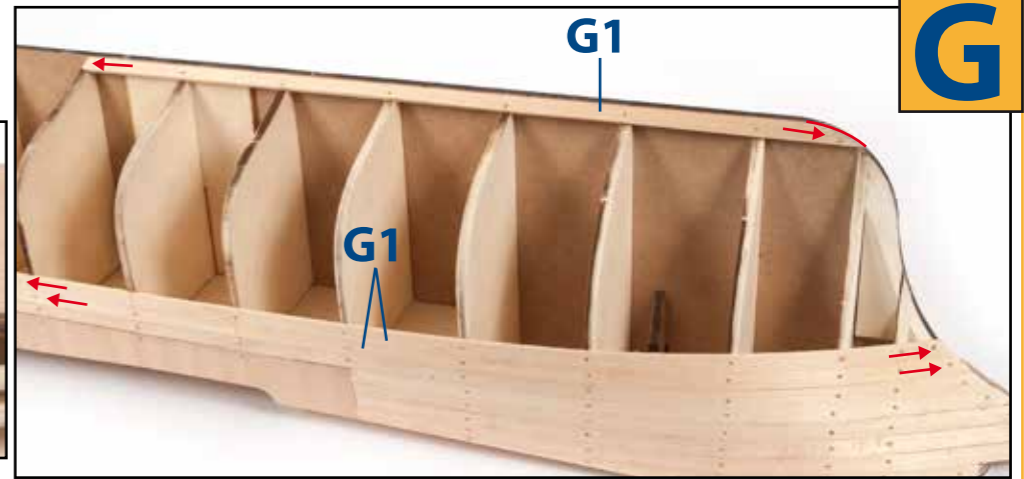
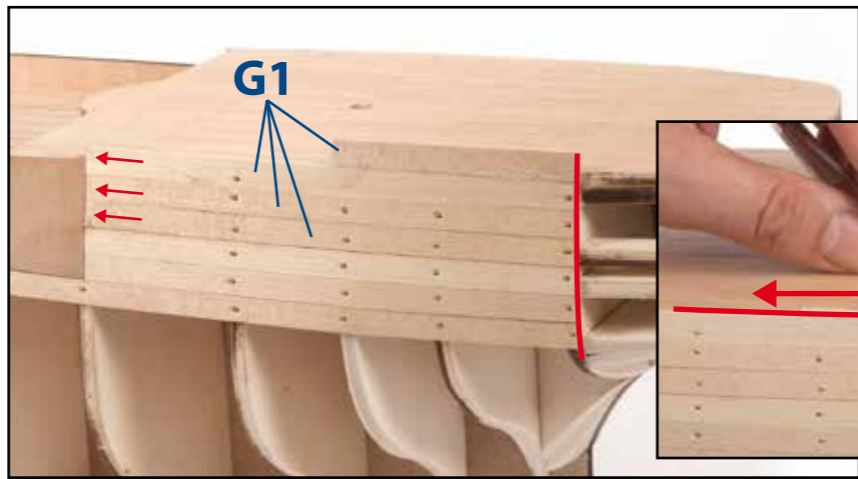
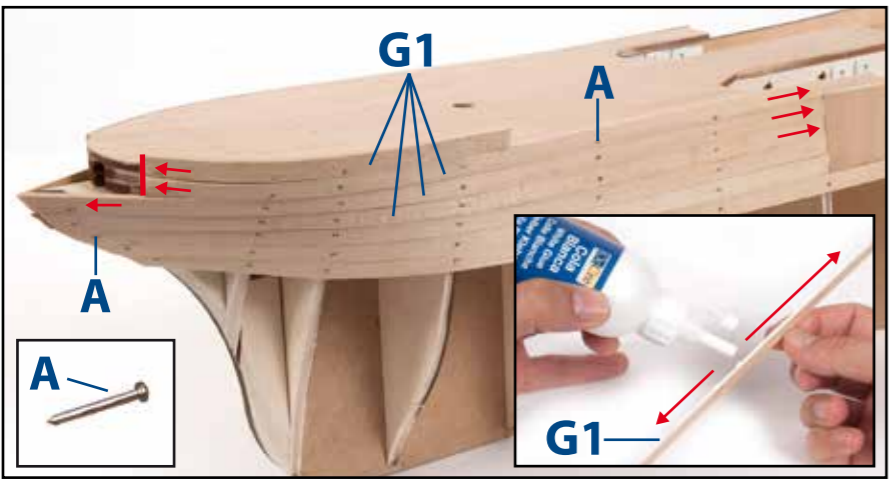

H

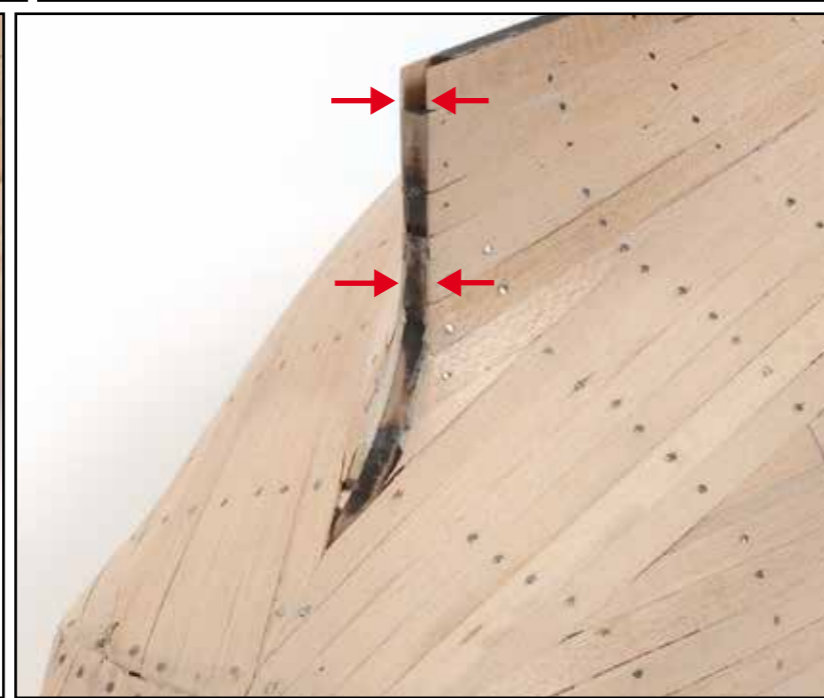
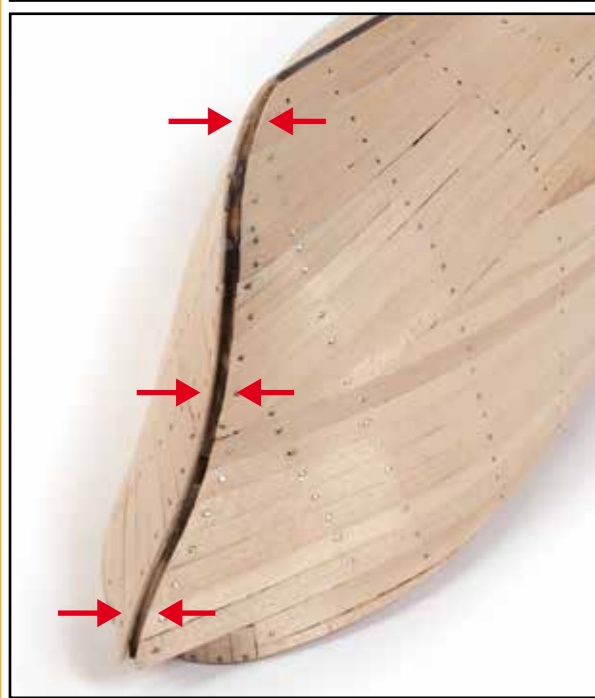
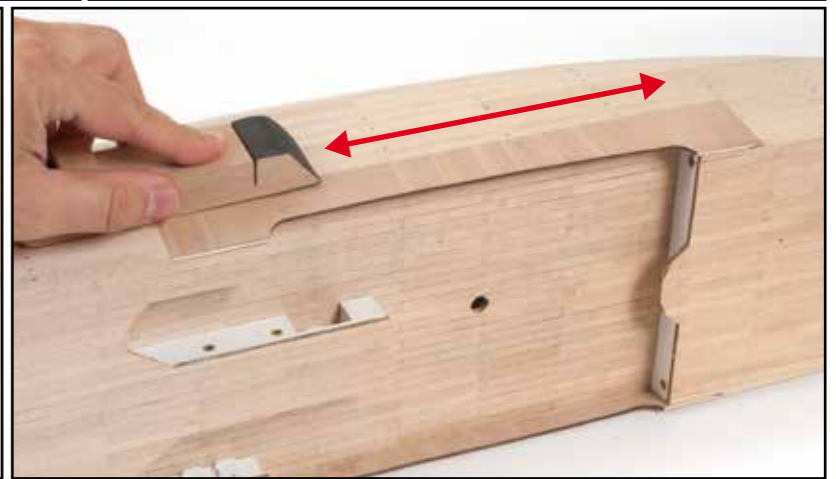
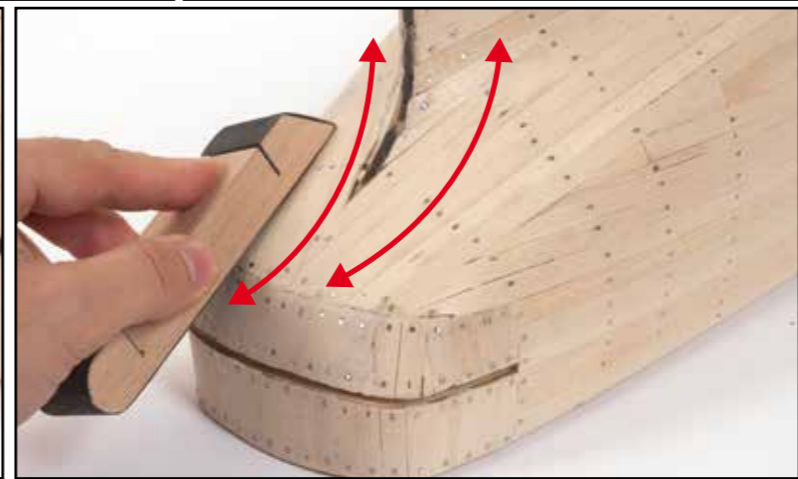
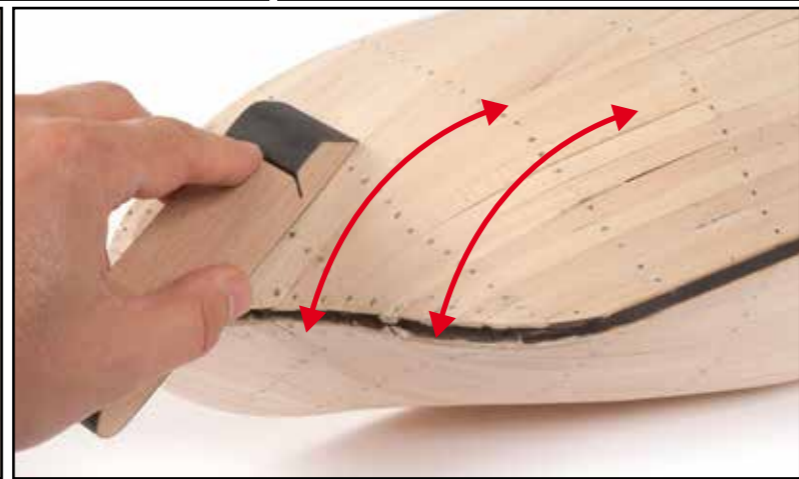
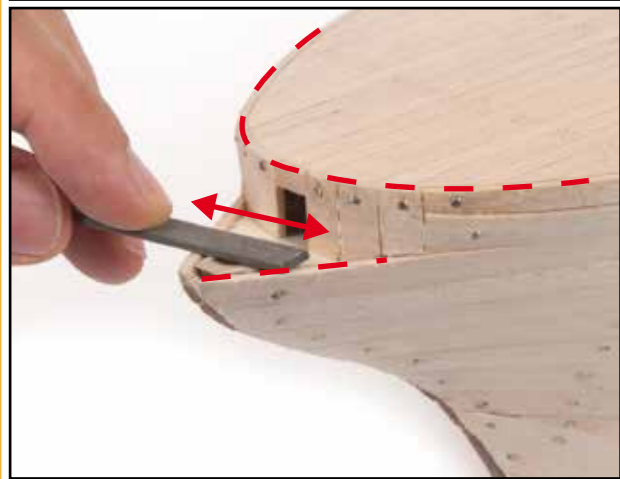
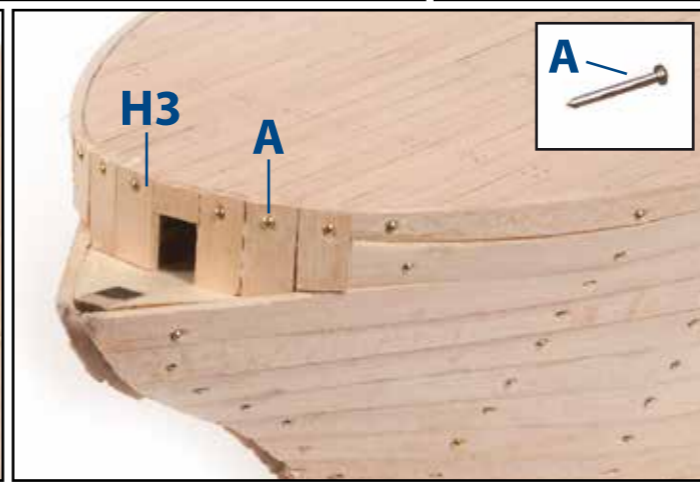
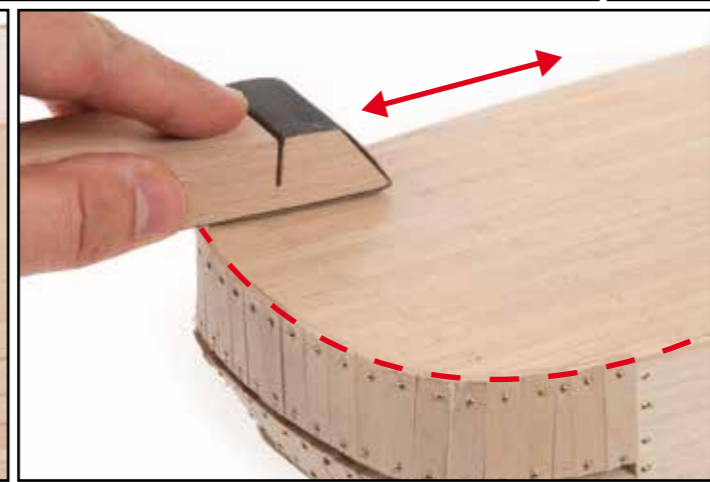
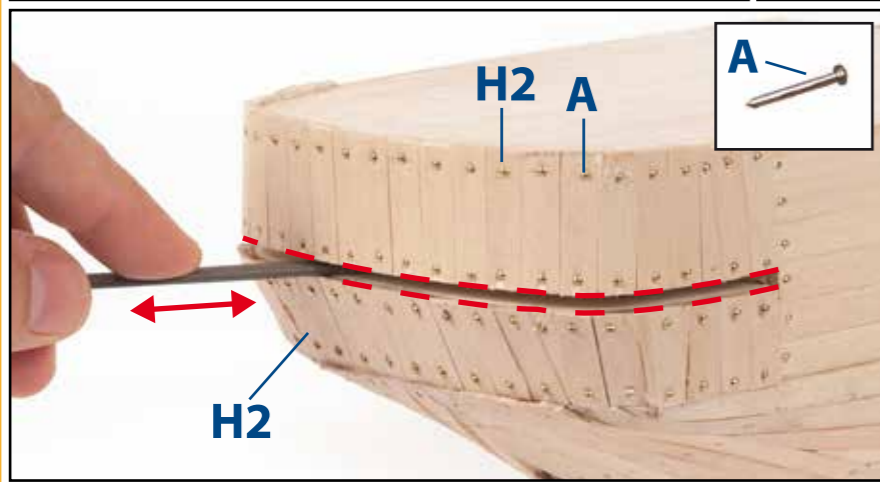
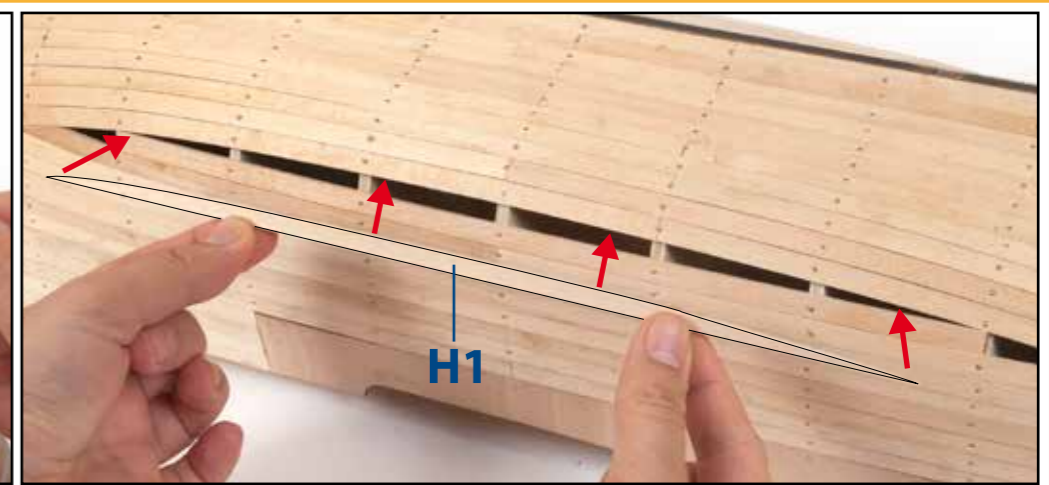
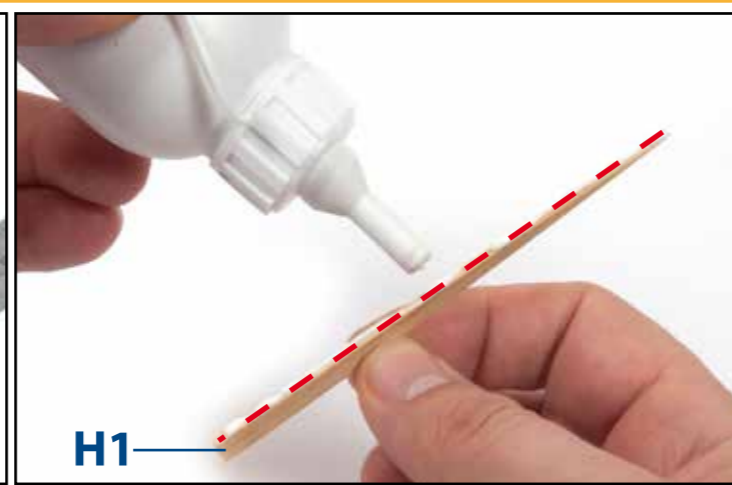
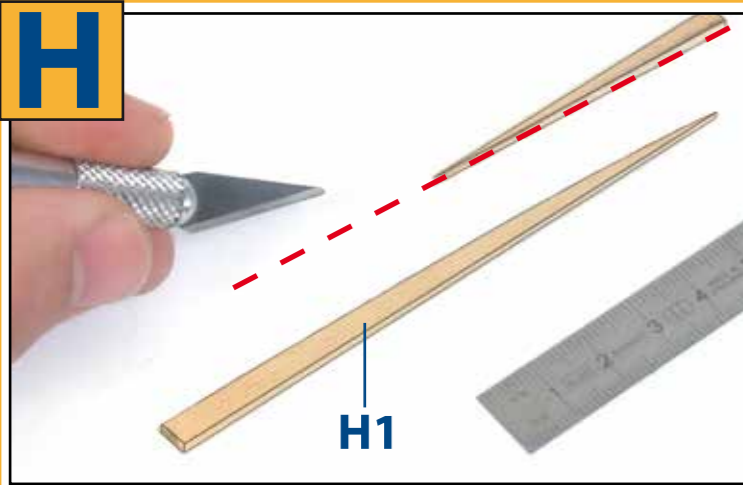

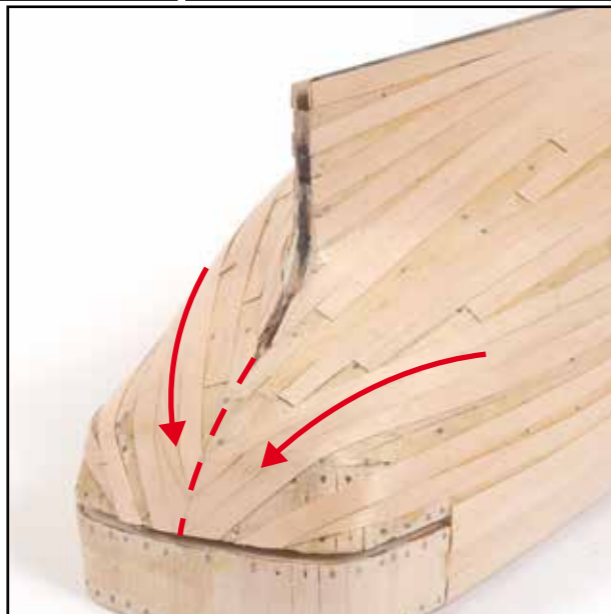
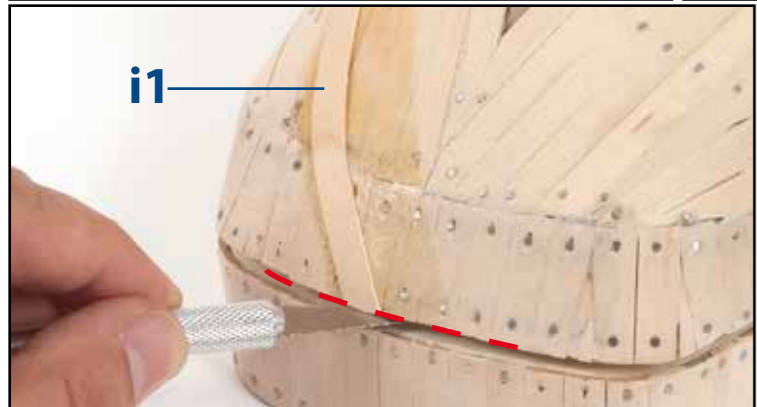
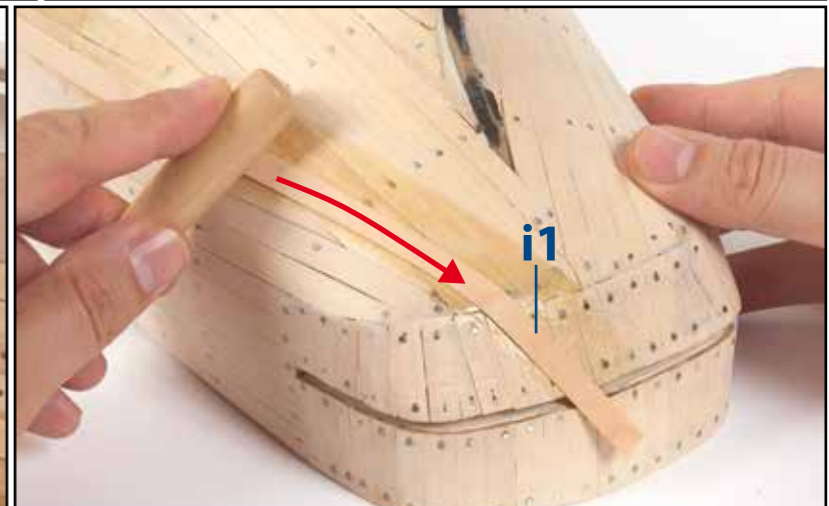
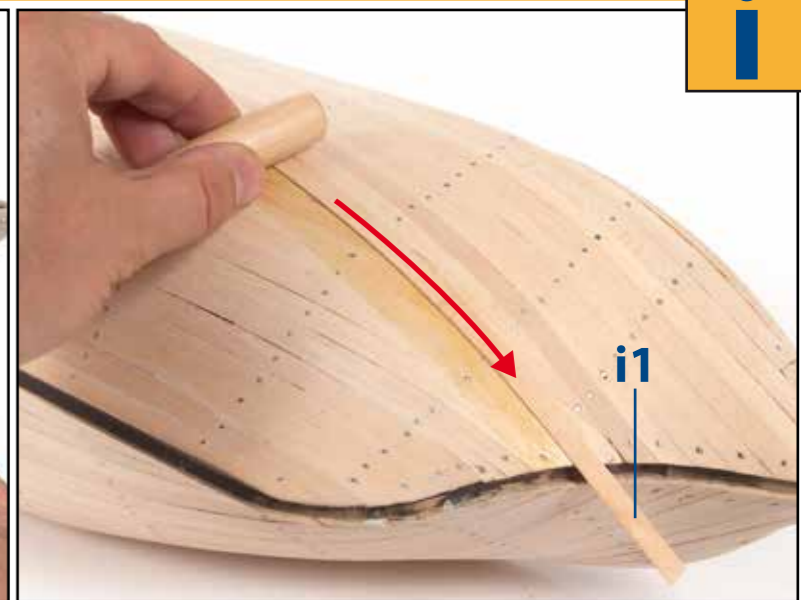
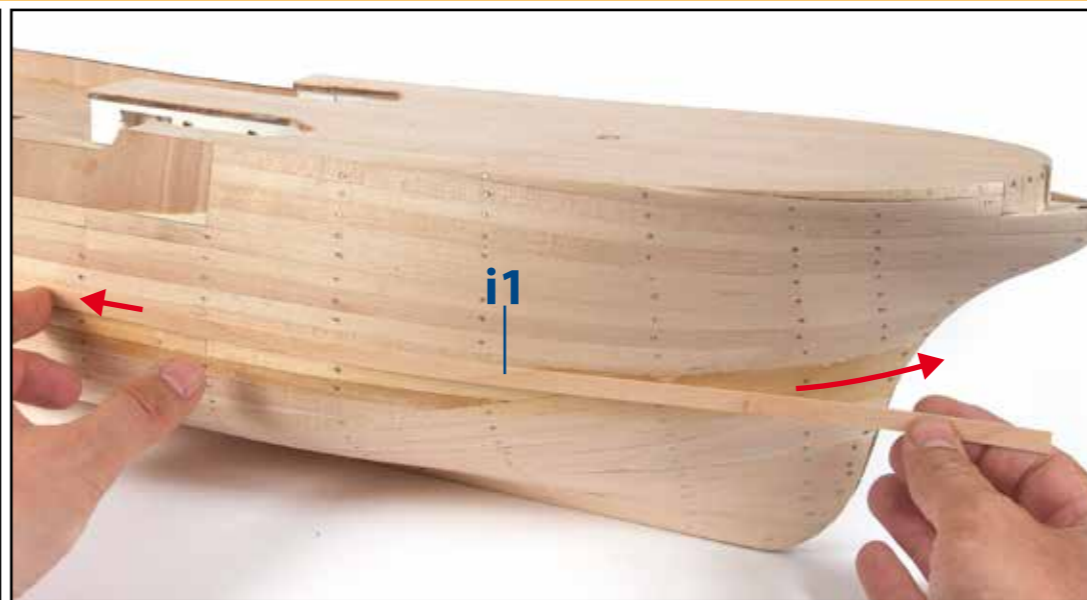
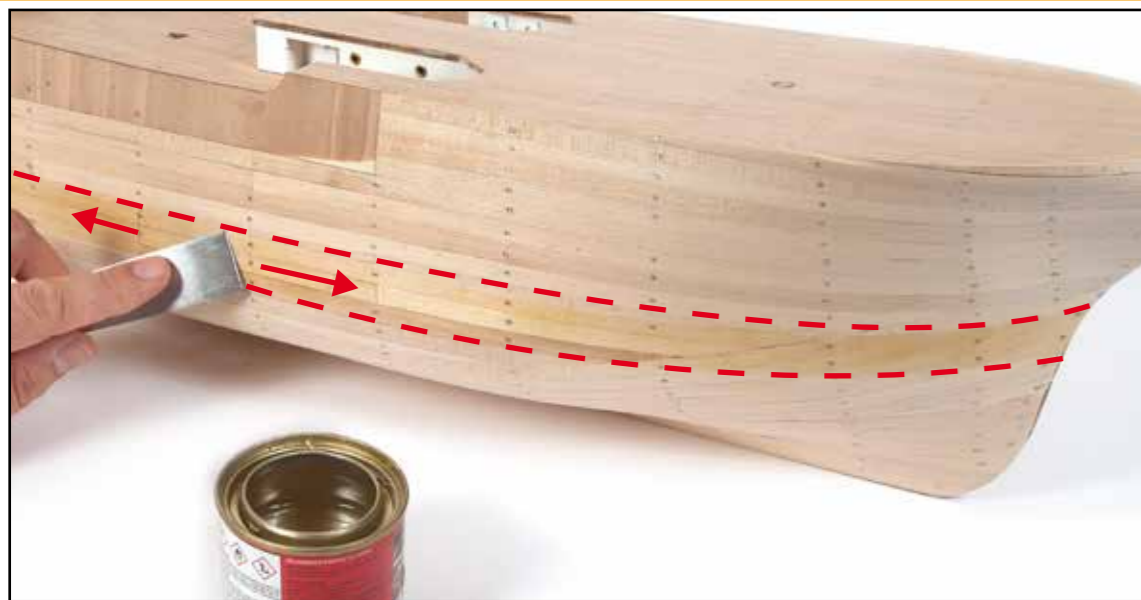

J

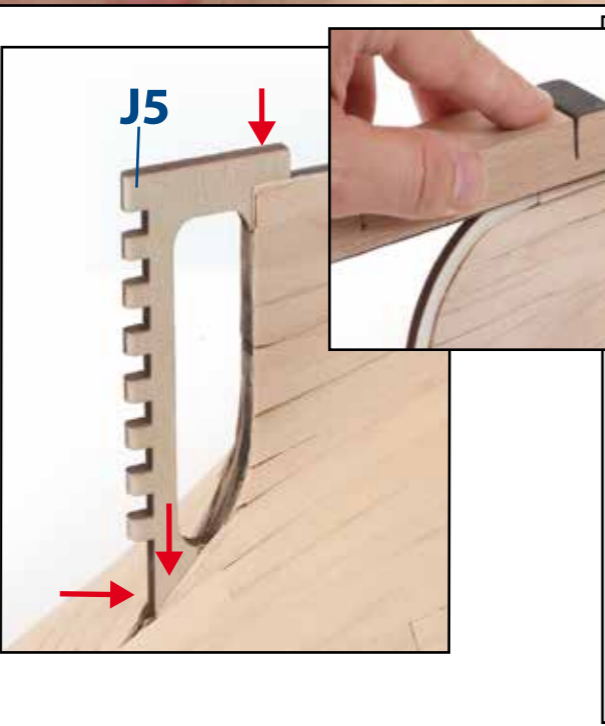
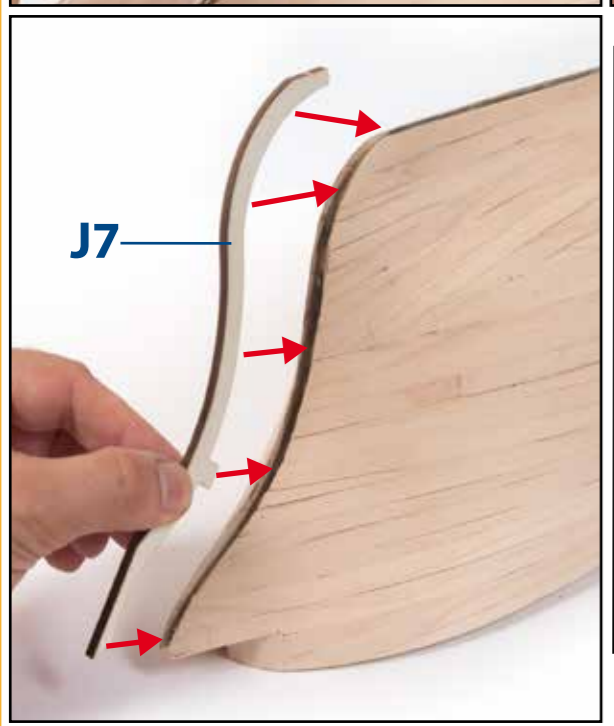
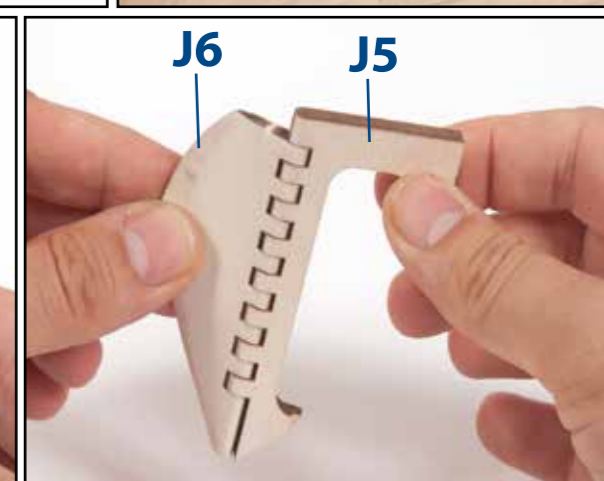
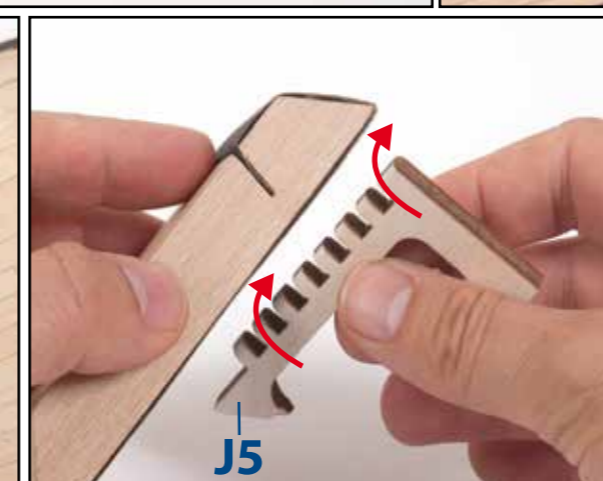
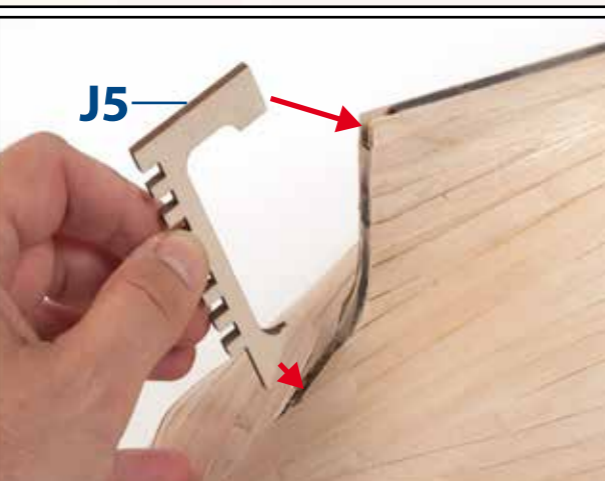
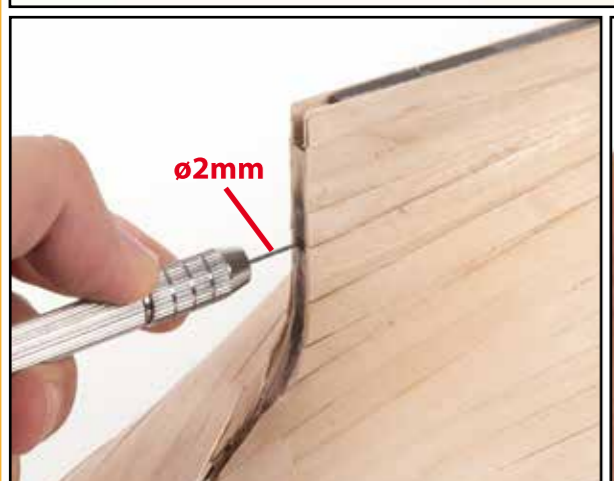
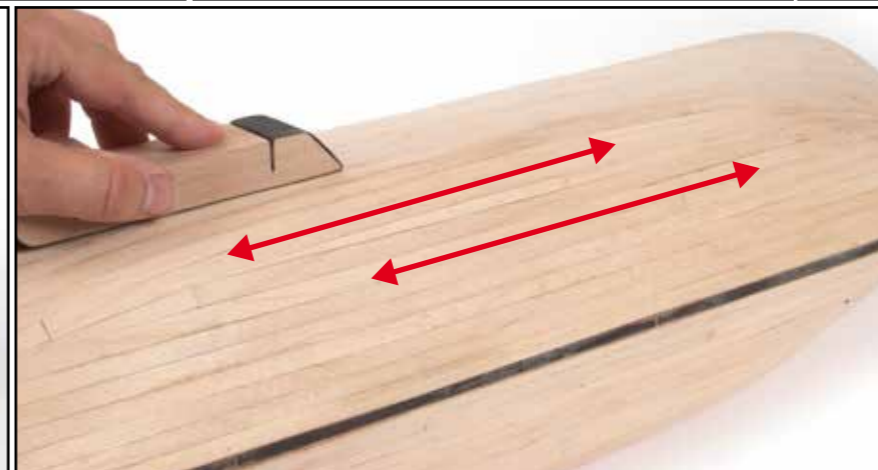
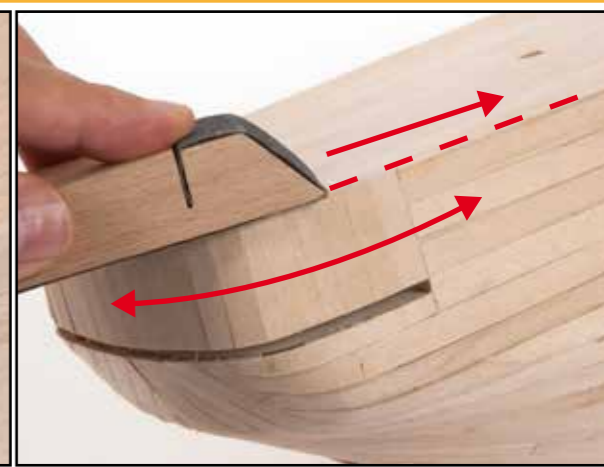
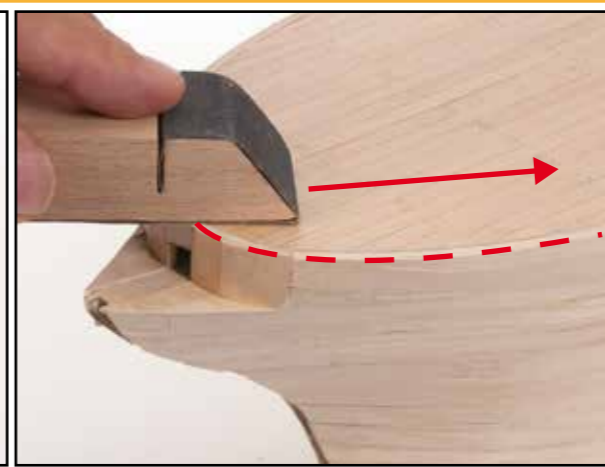
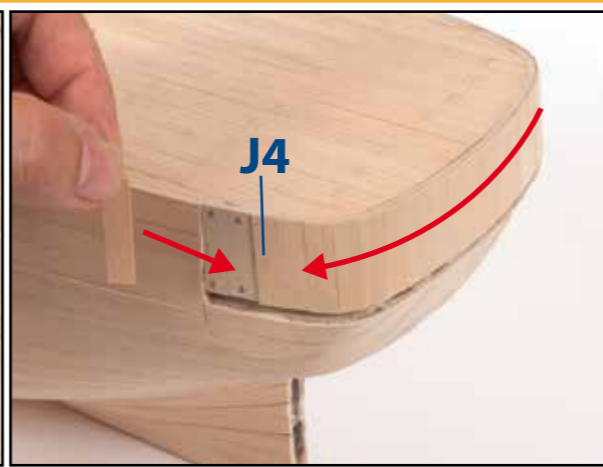
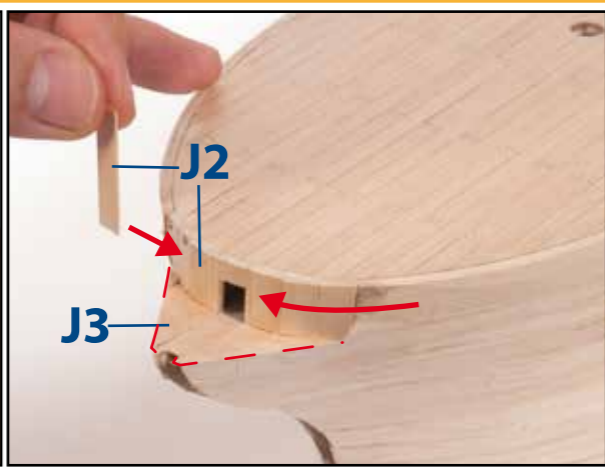

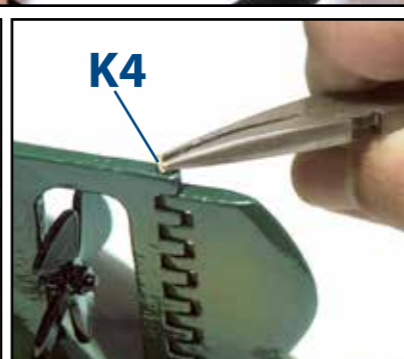
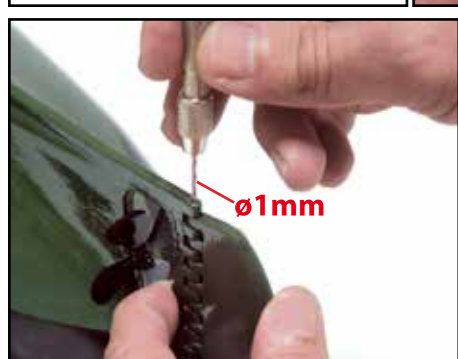
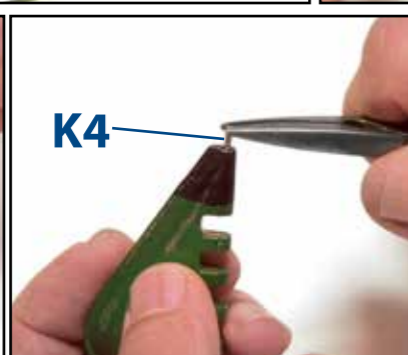
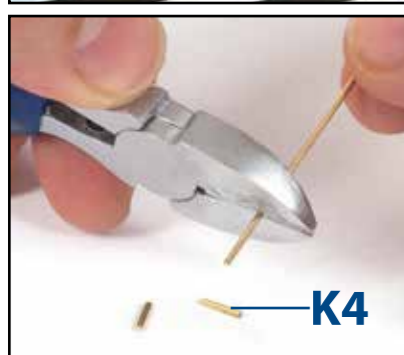
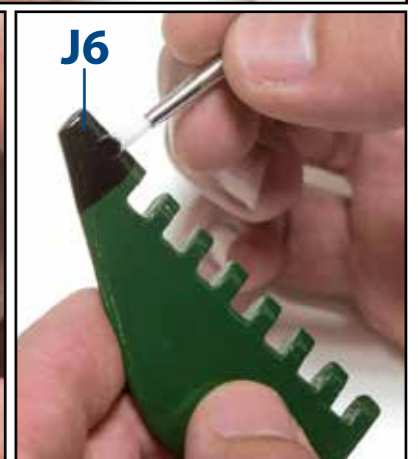
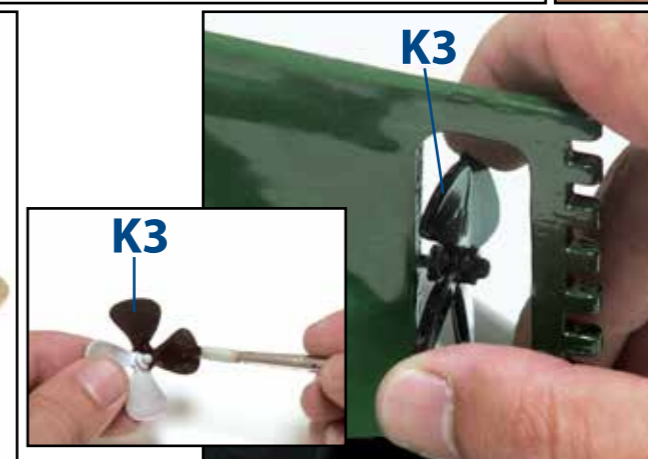
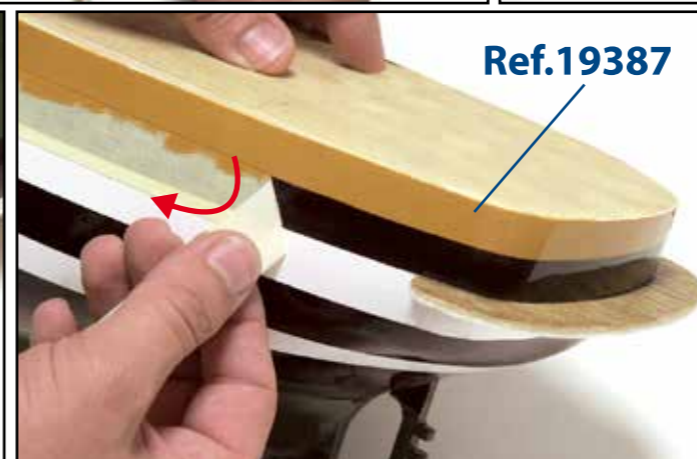
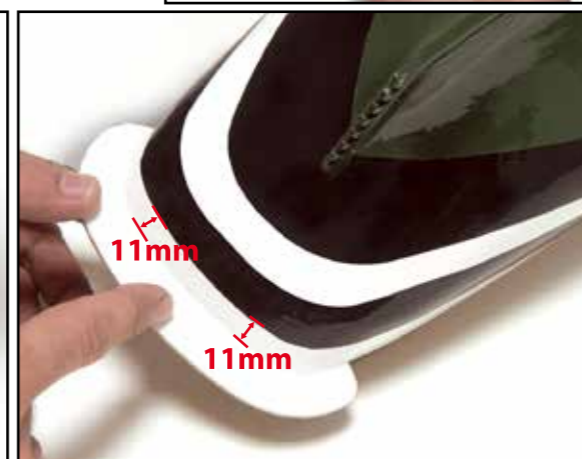
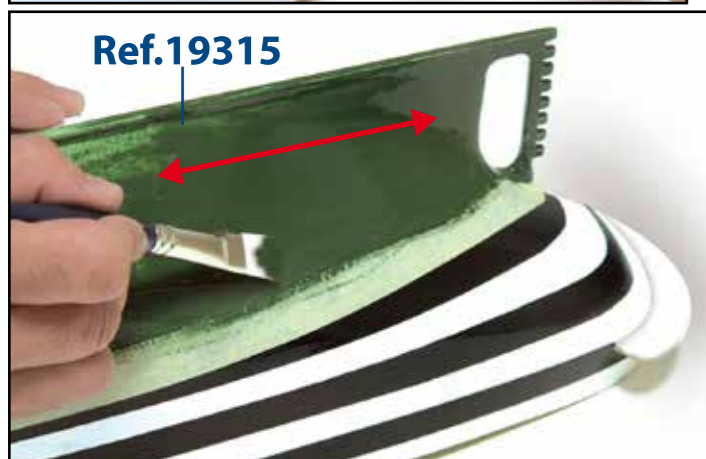
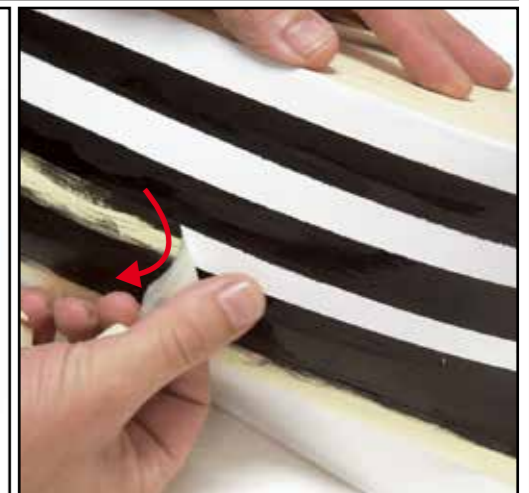
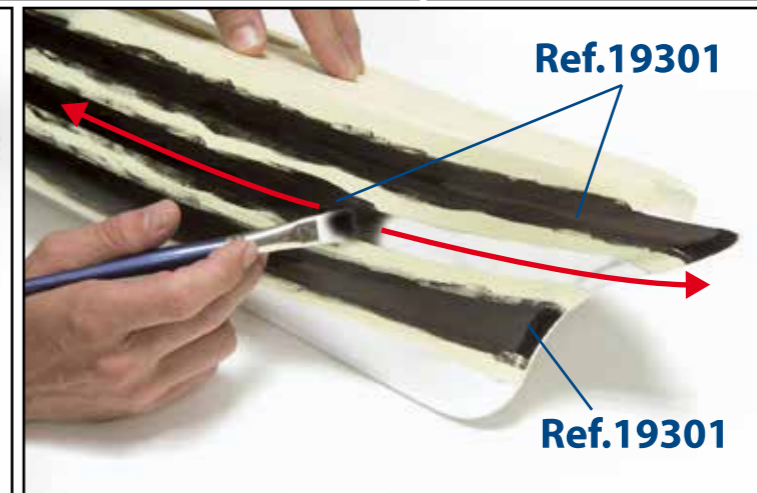
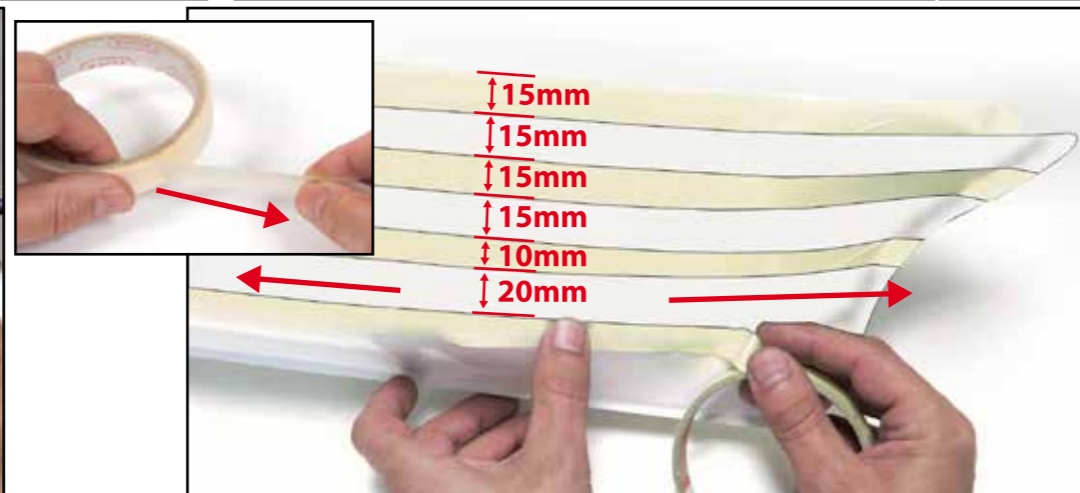
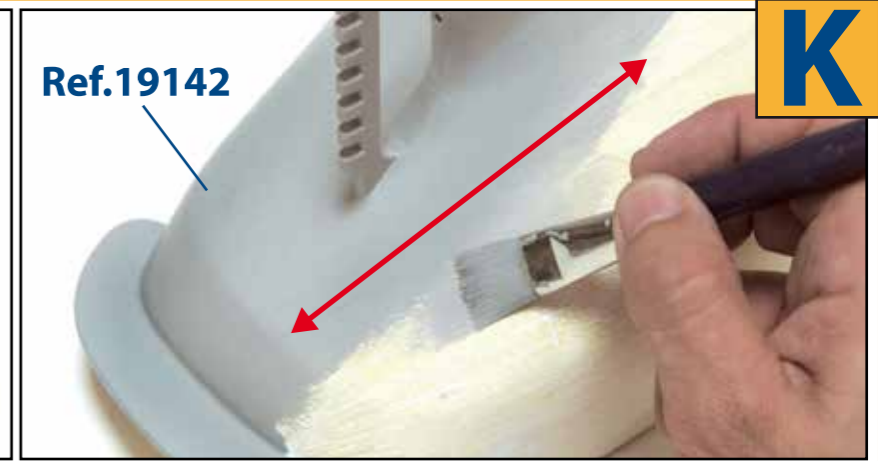
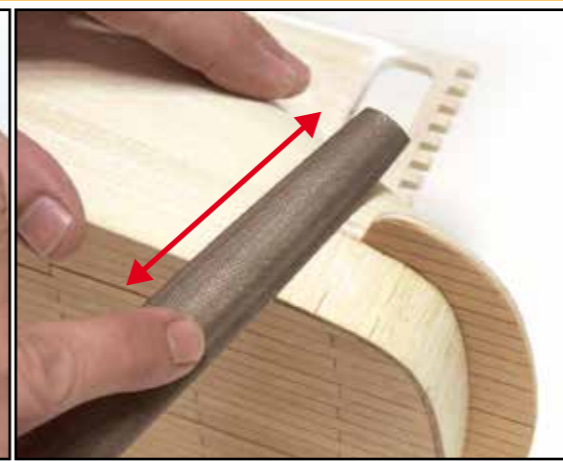
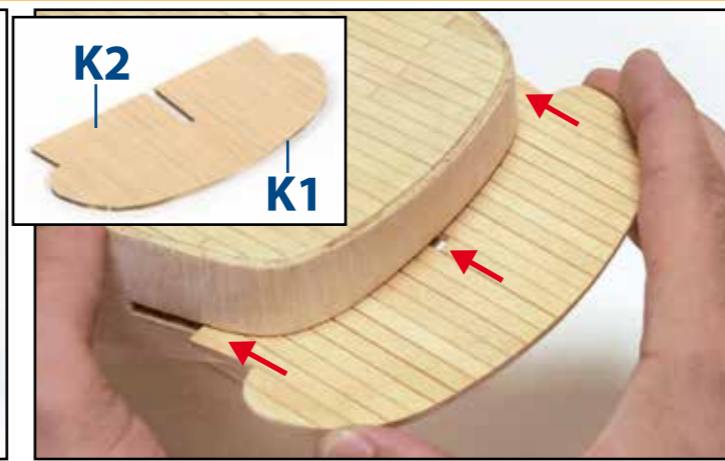

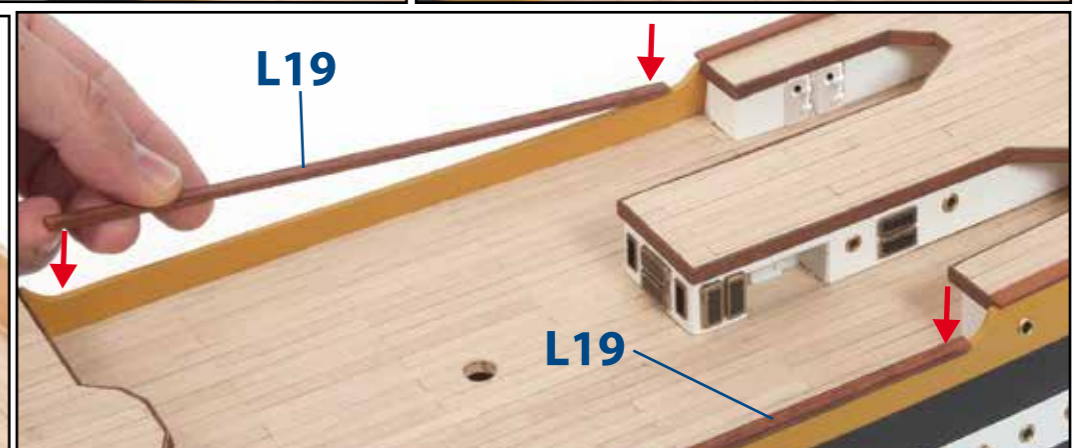
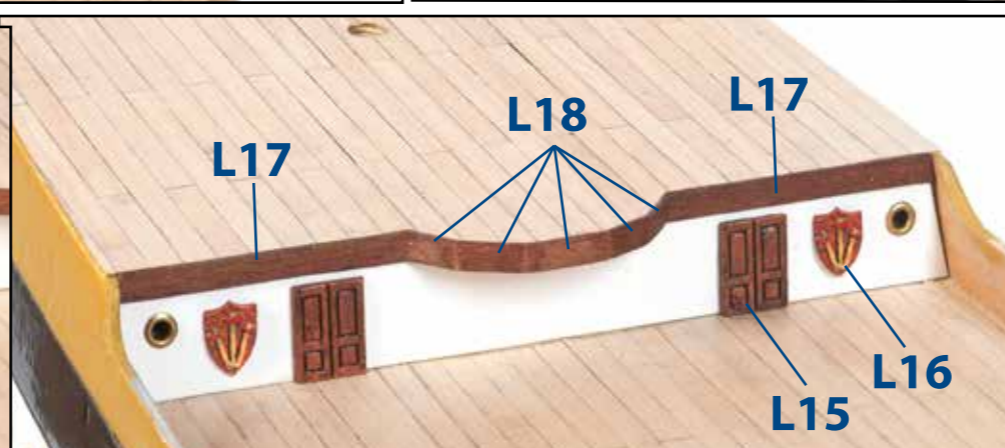
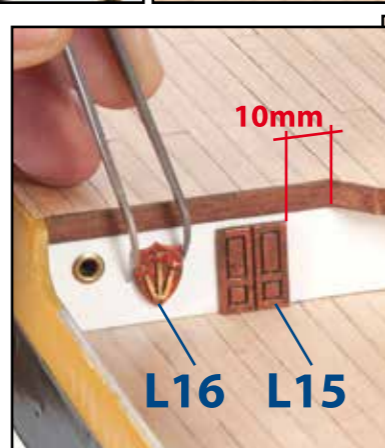
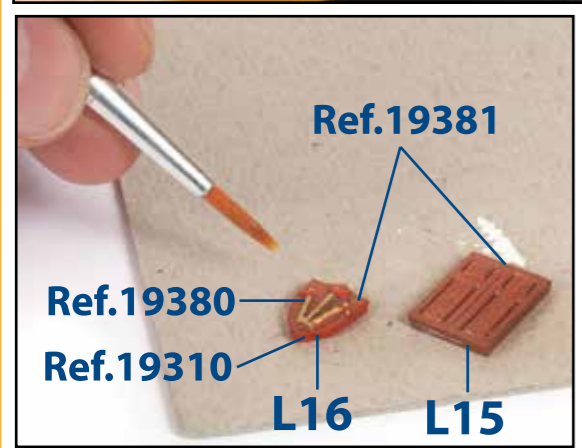
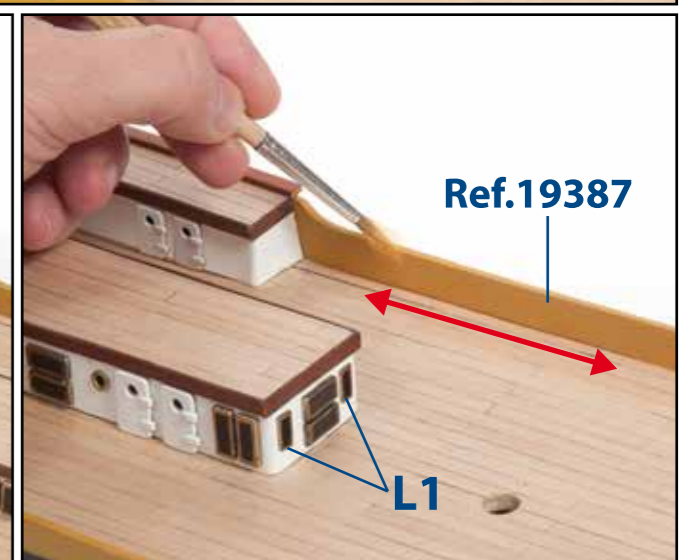
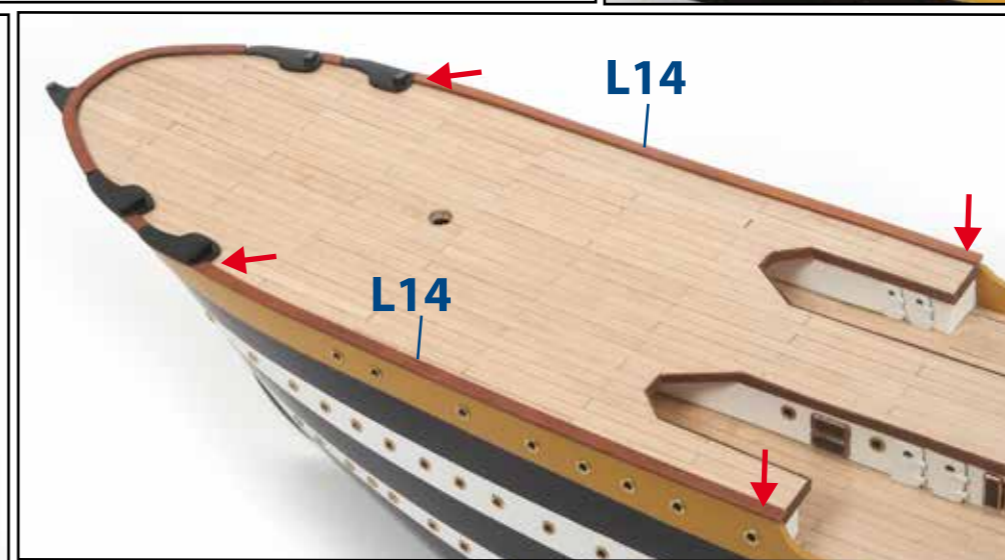
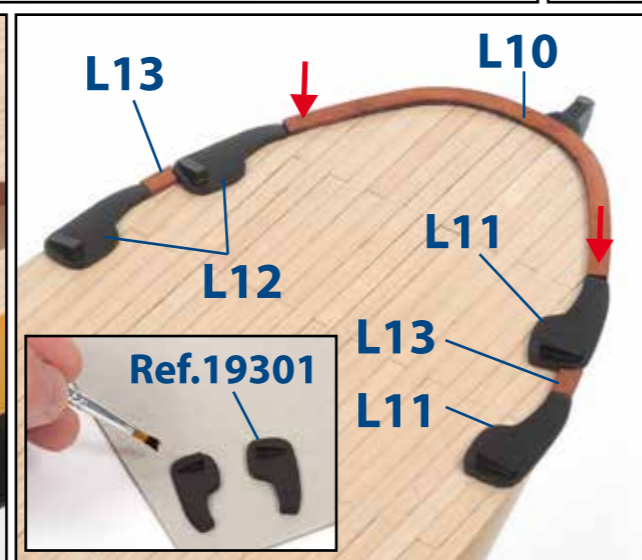
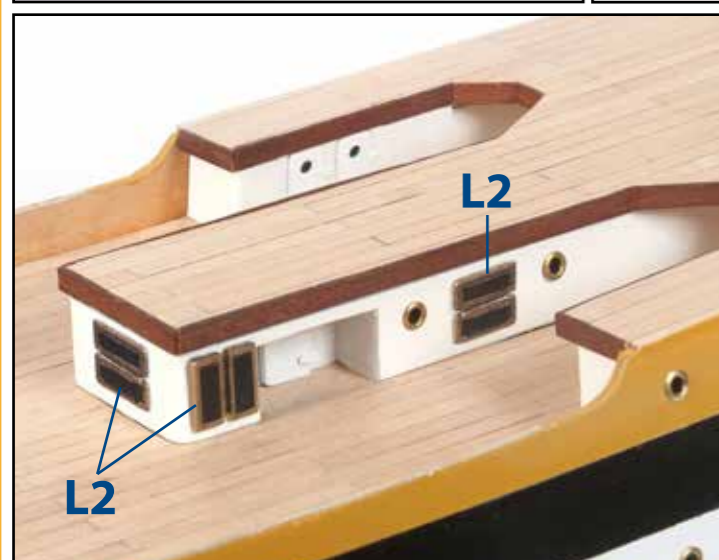
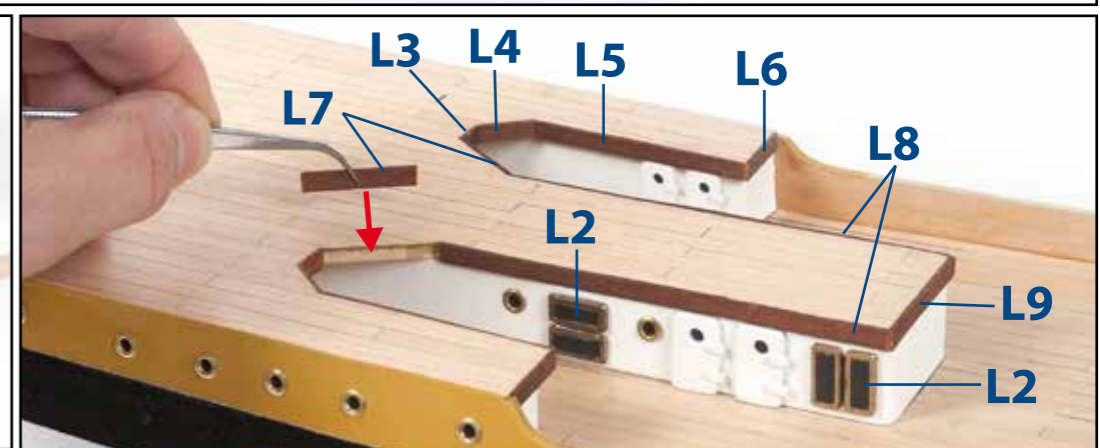
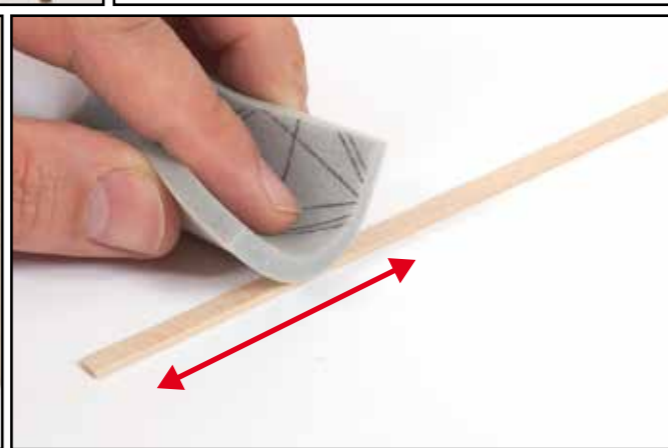
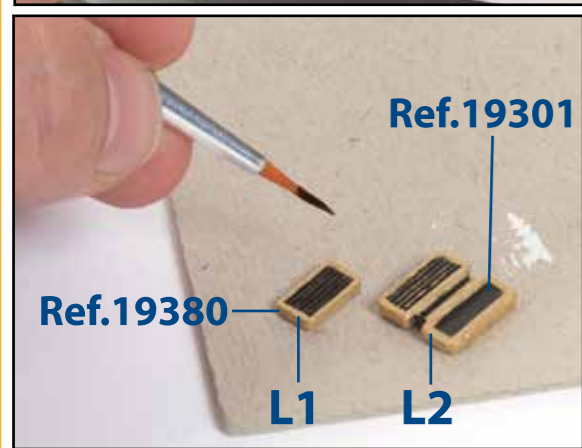
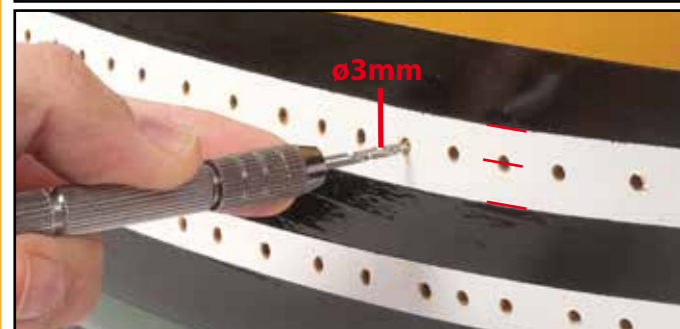

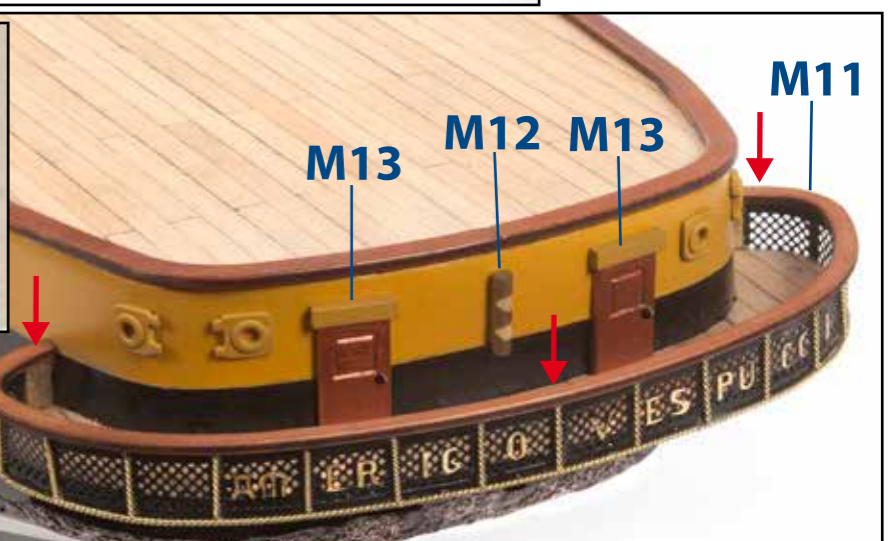
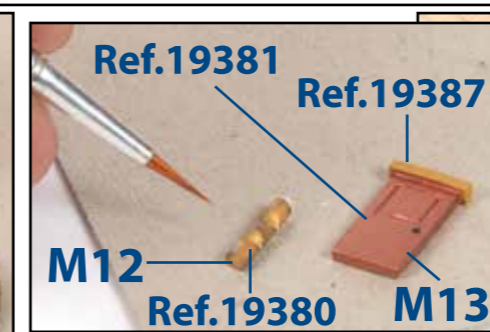
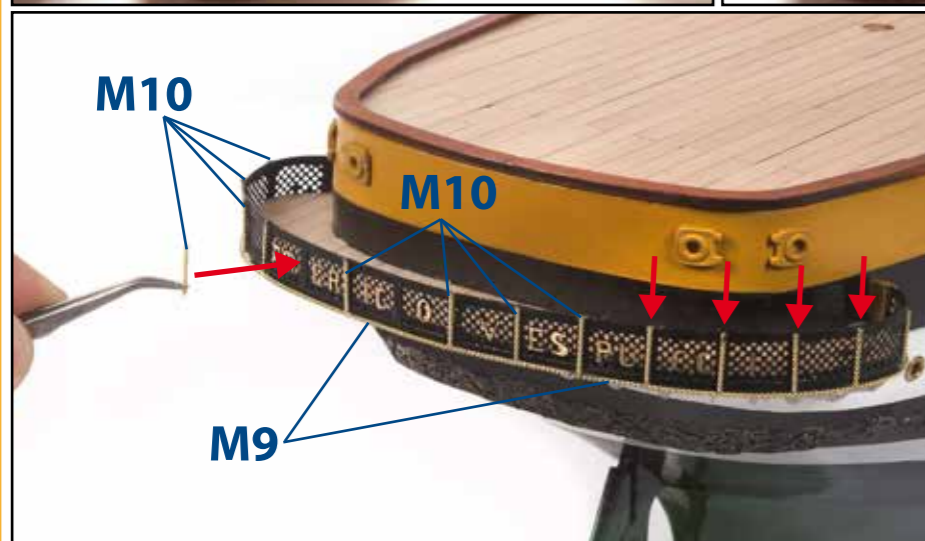
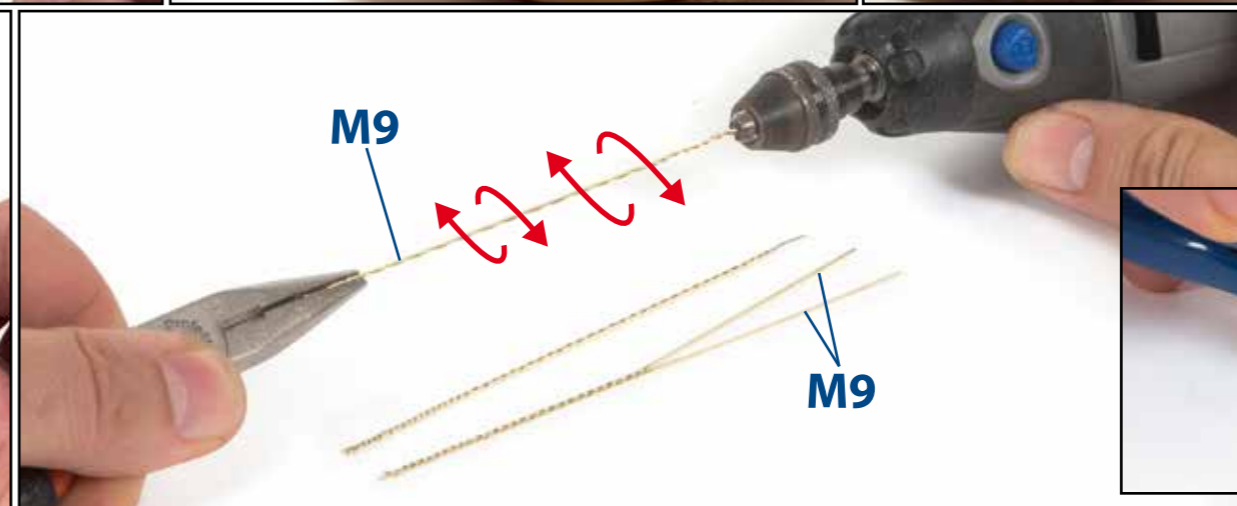
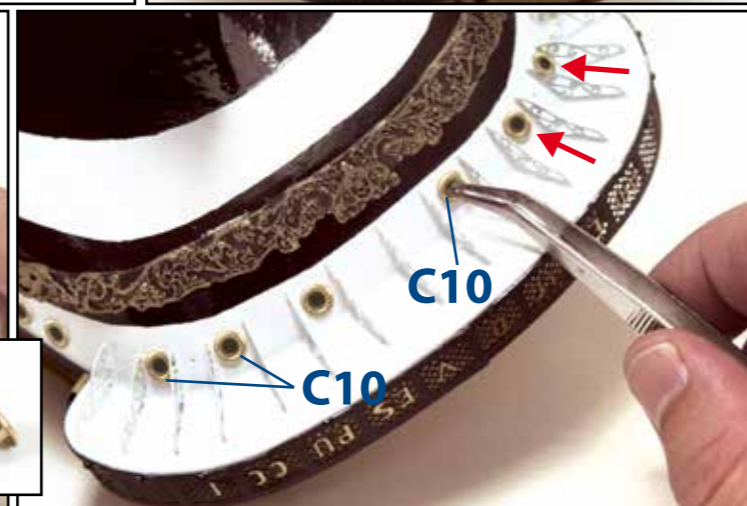
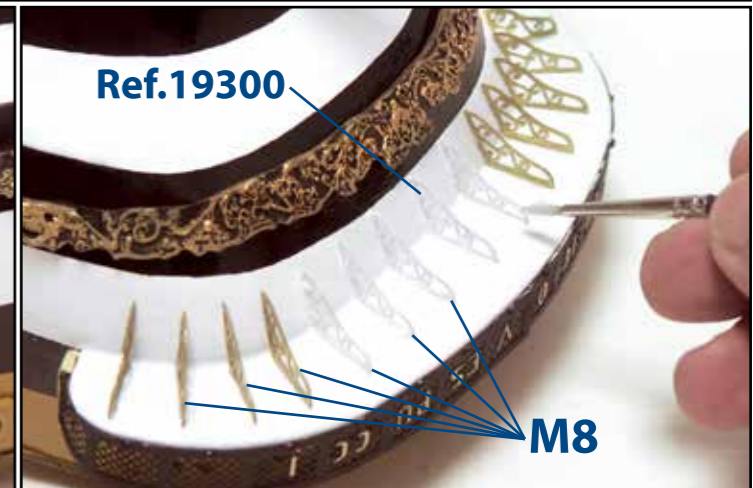
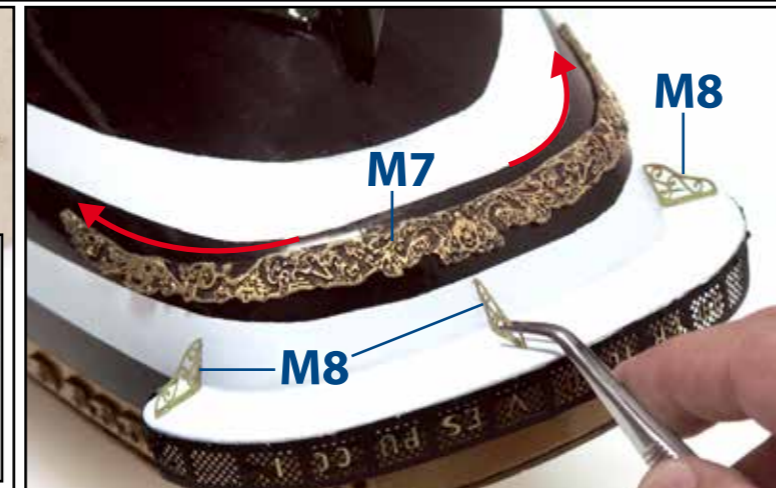
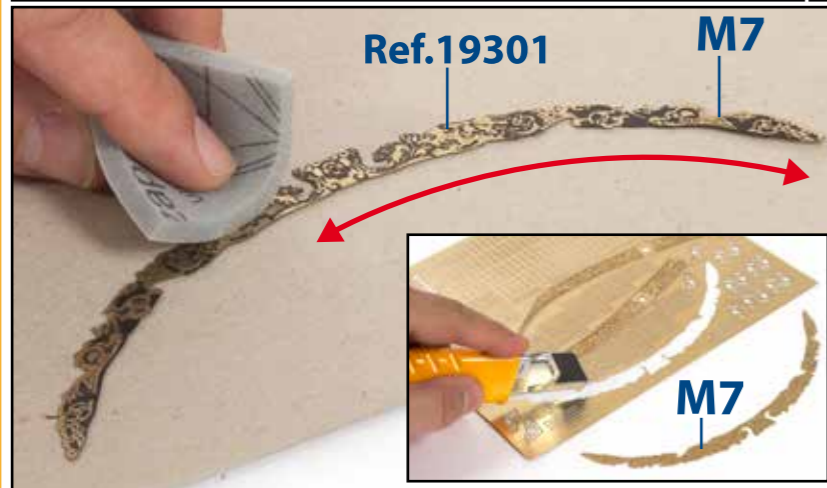
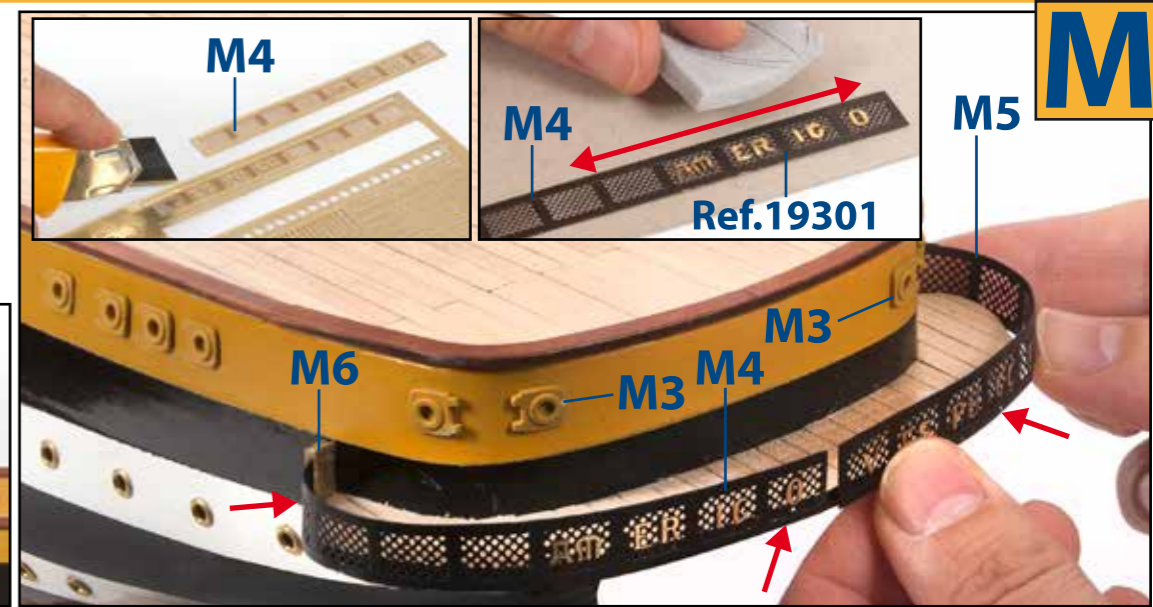
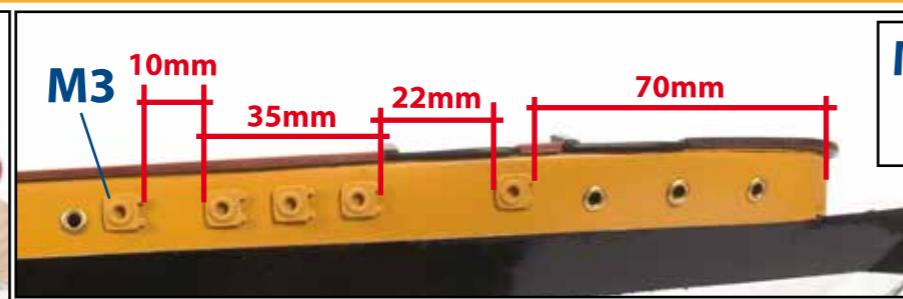
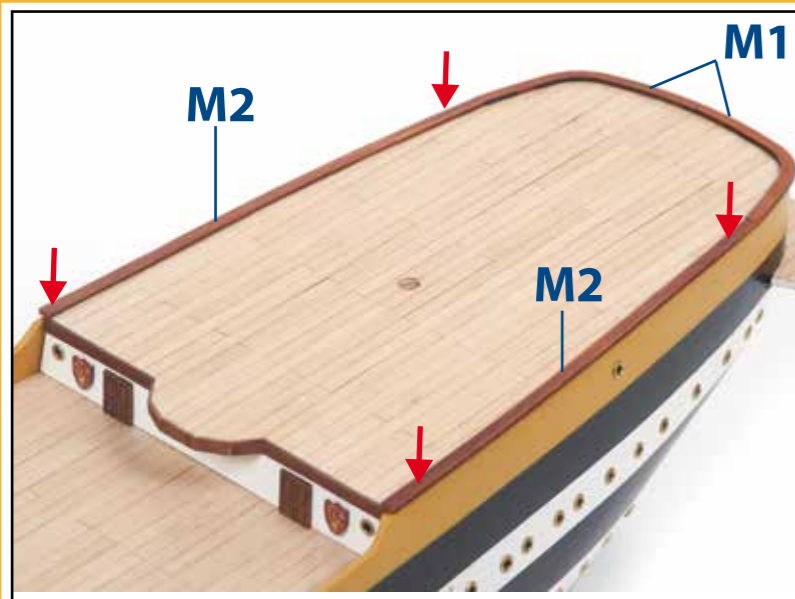

N

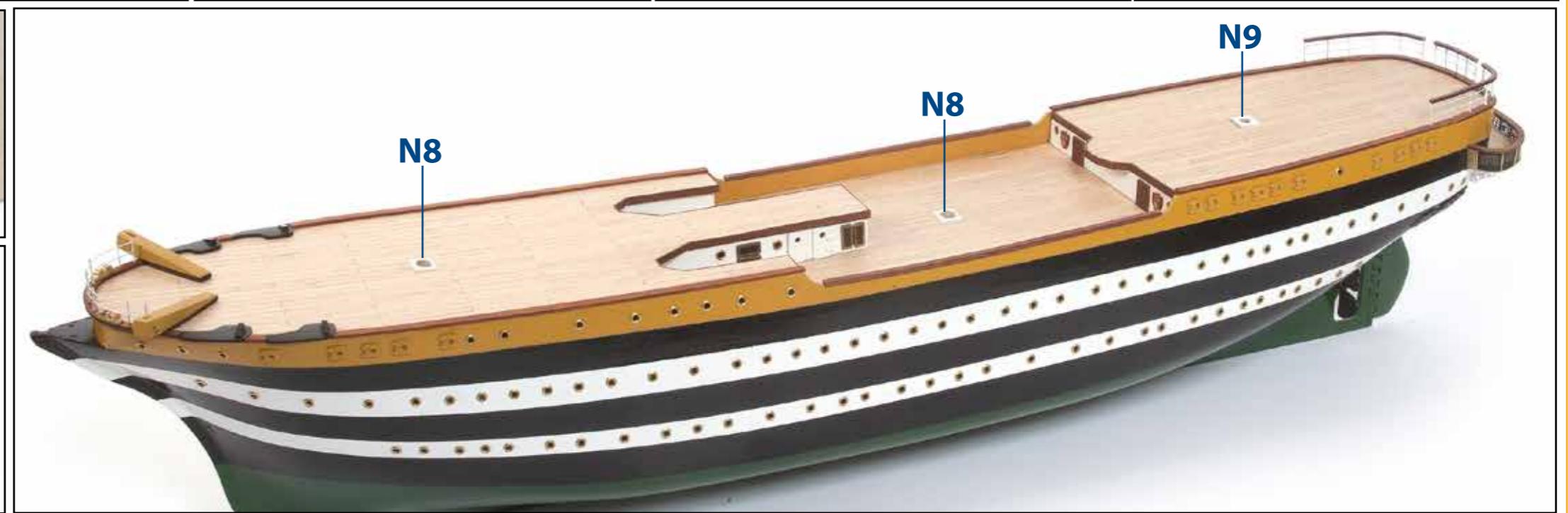
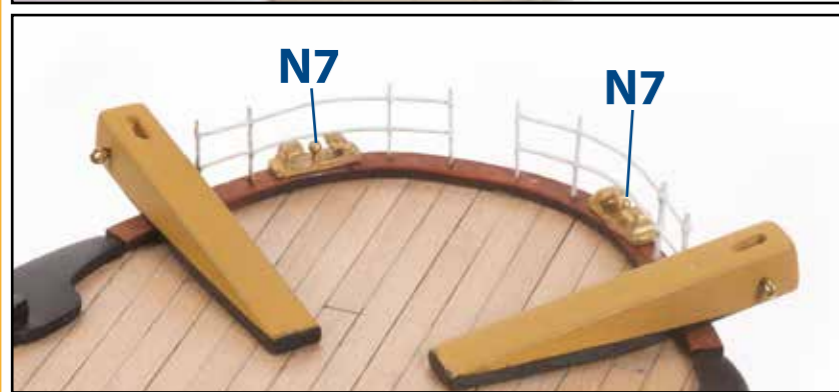
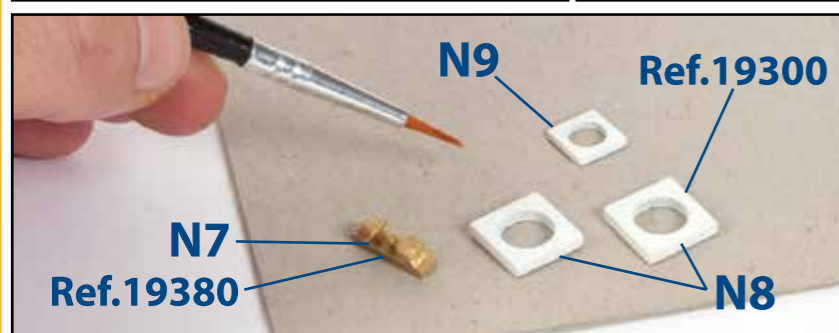
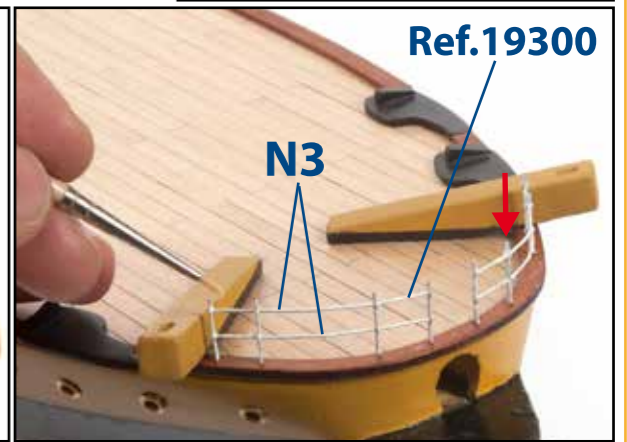
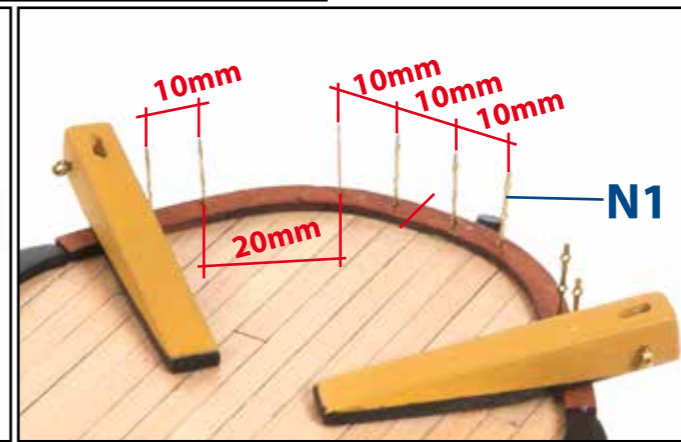
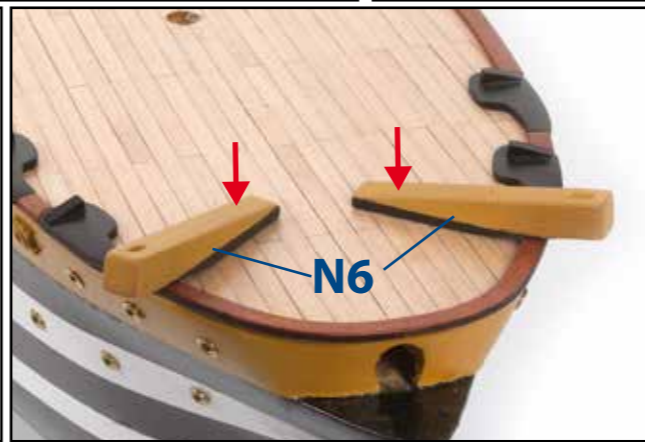
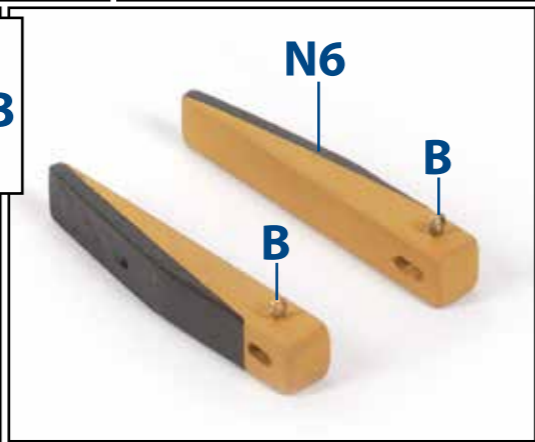
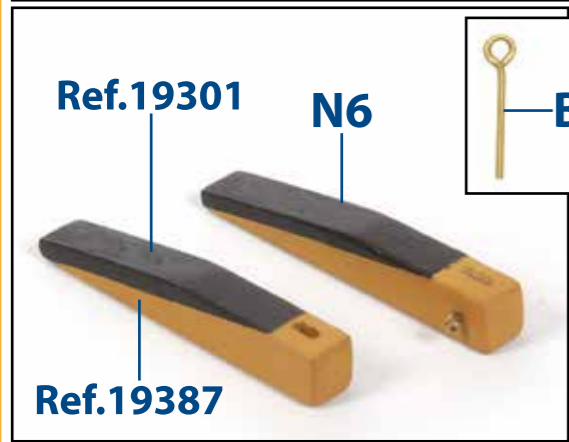
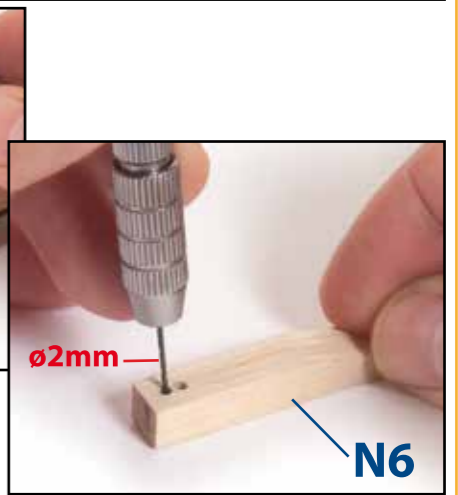
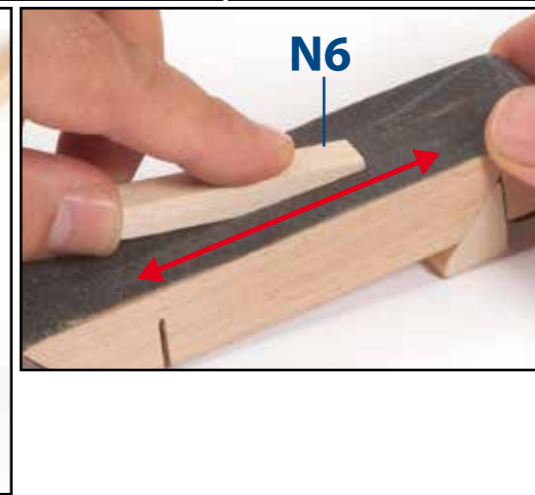
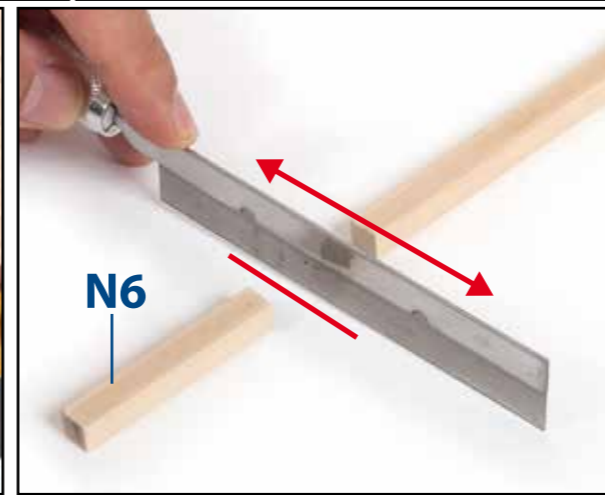
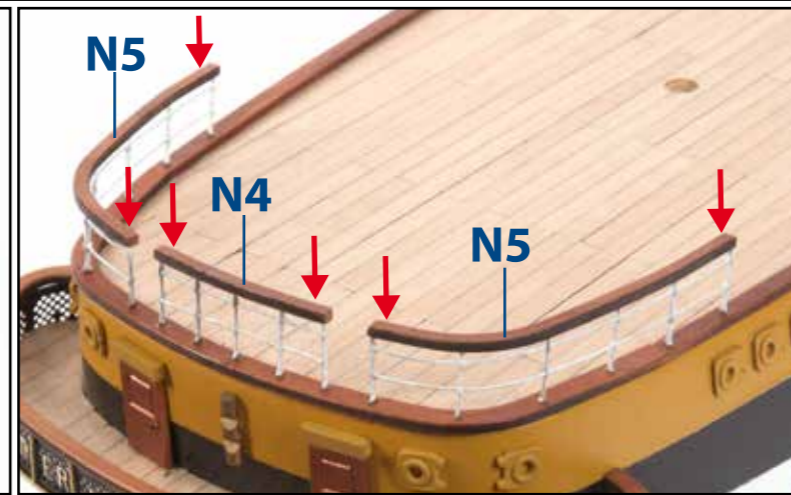
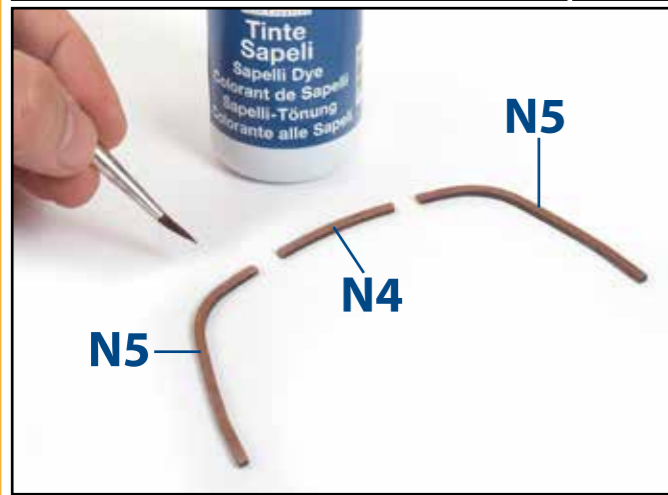
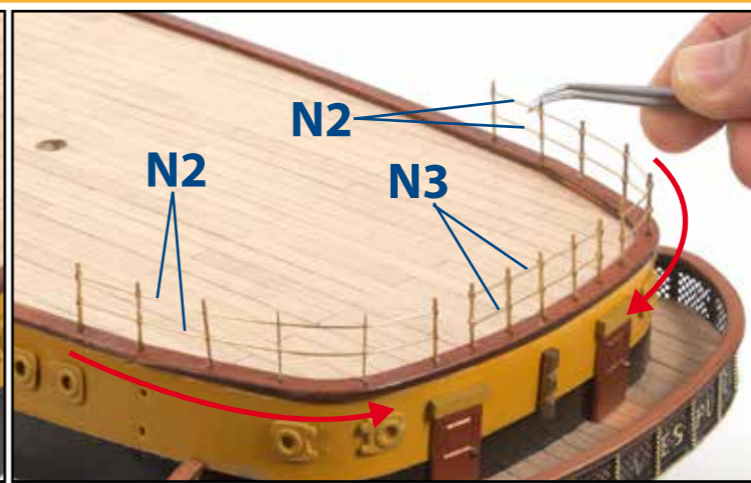
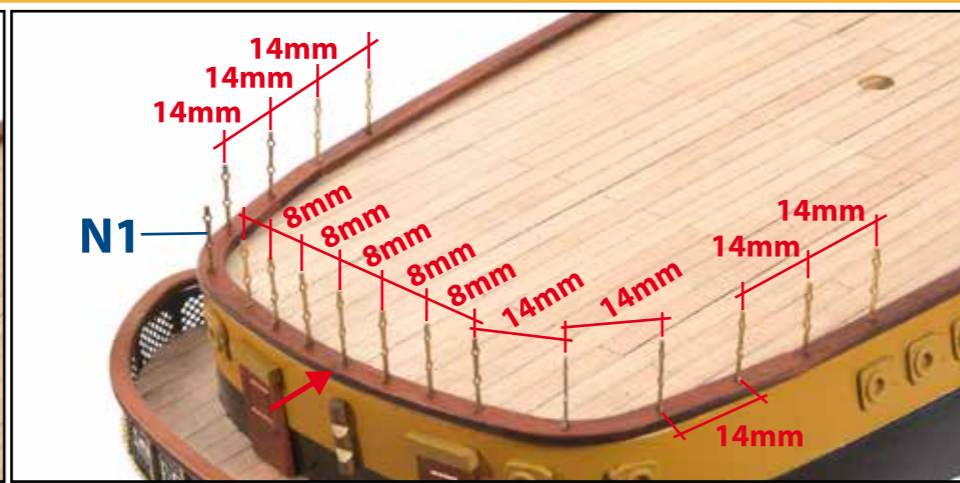
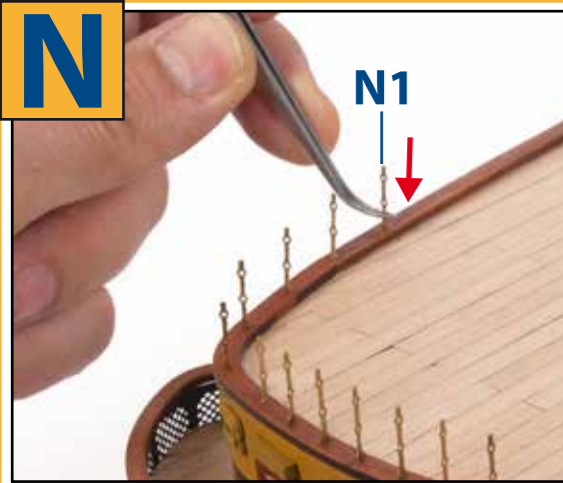

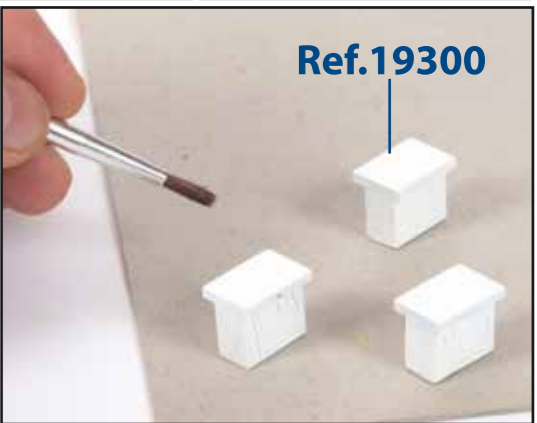
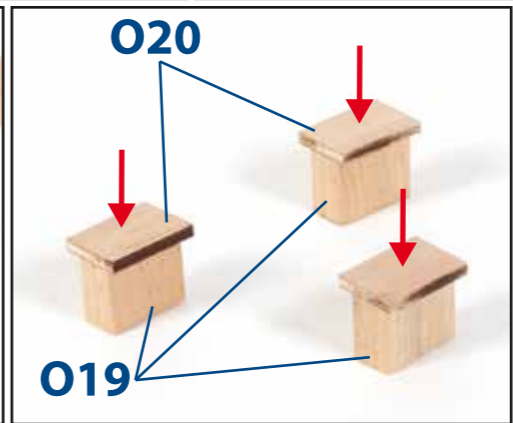
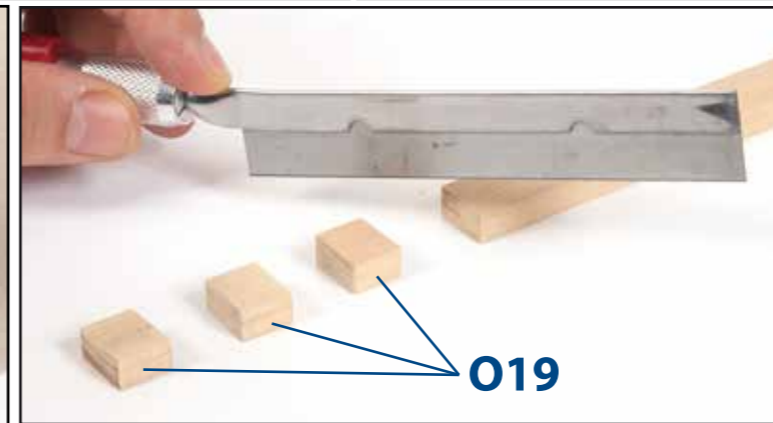
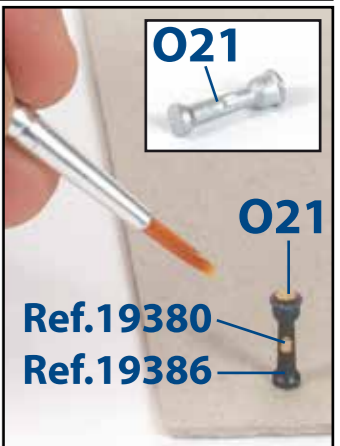
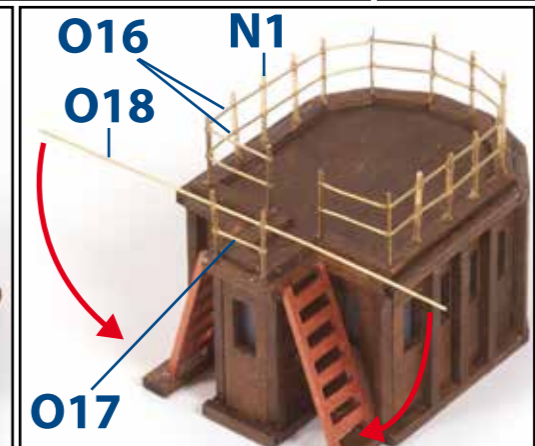
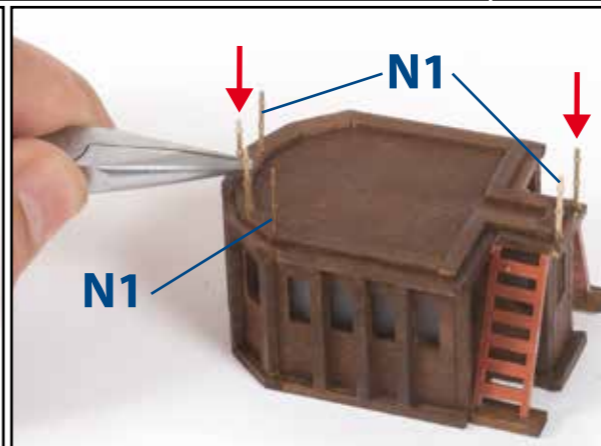
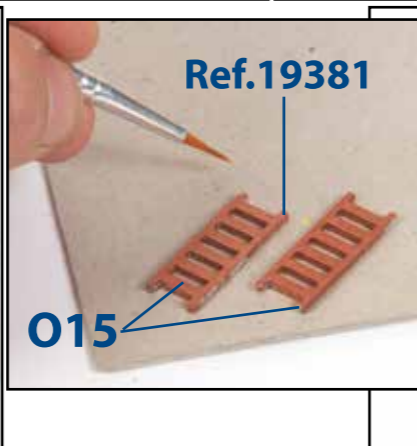
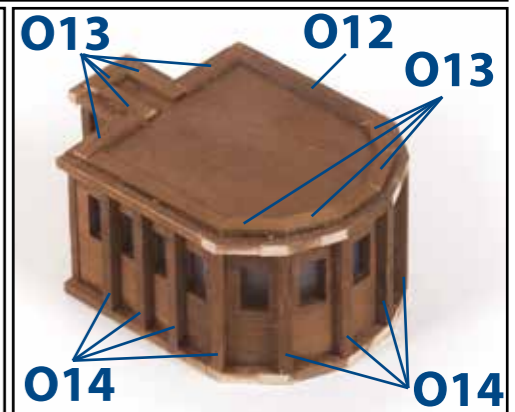
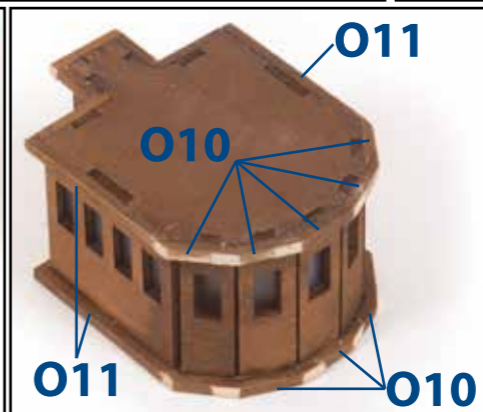
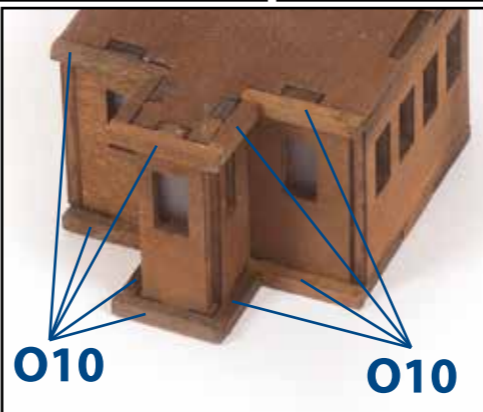
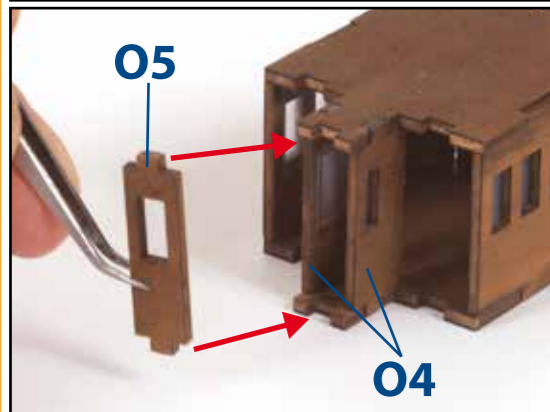
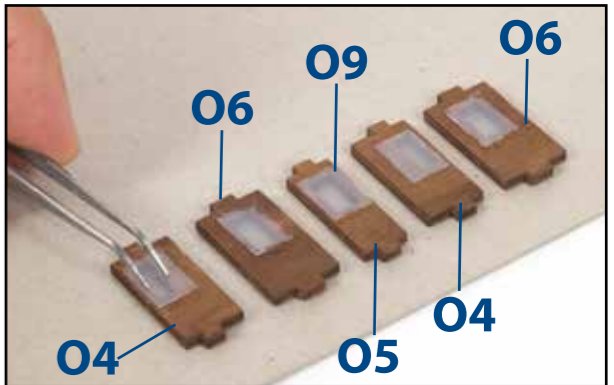
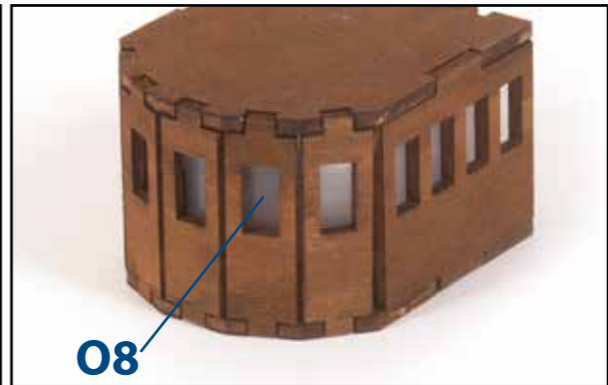
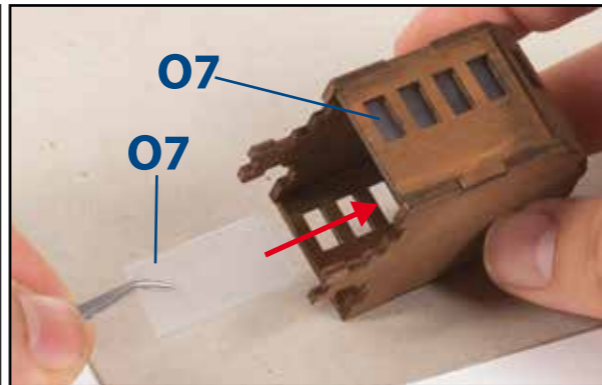
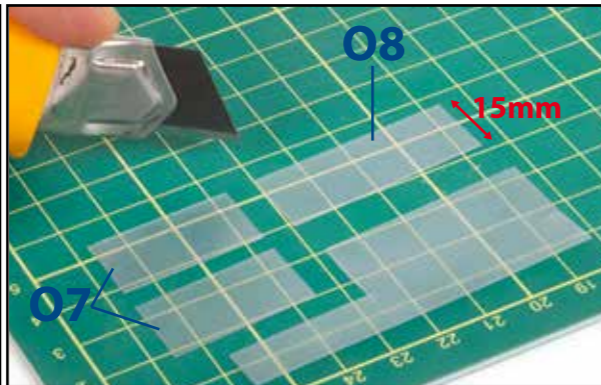
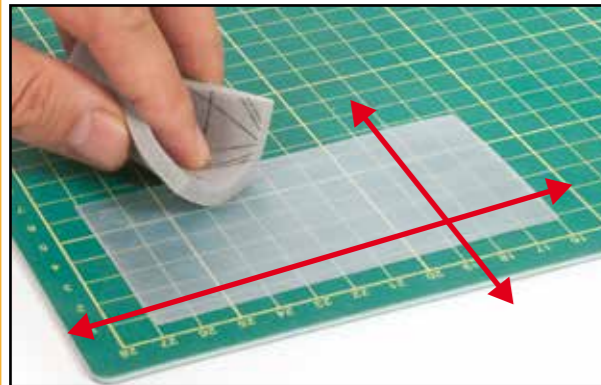
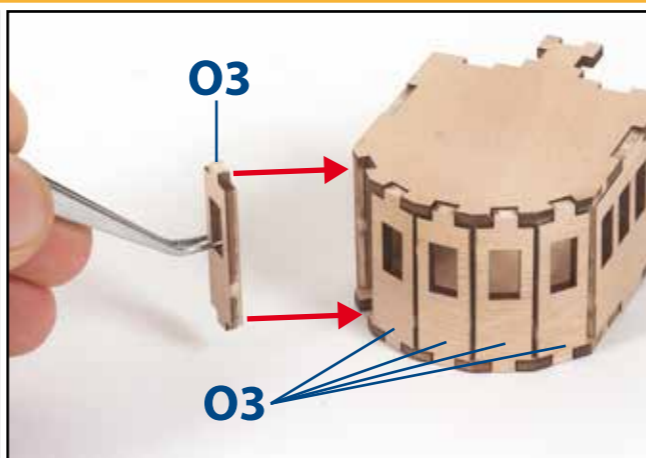
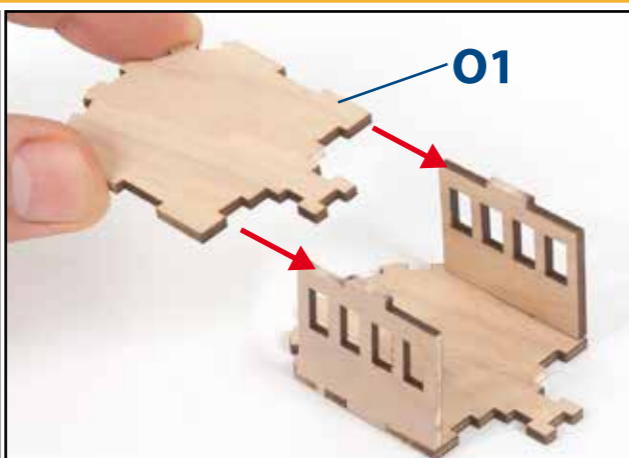
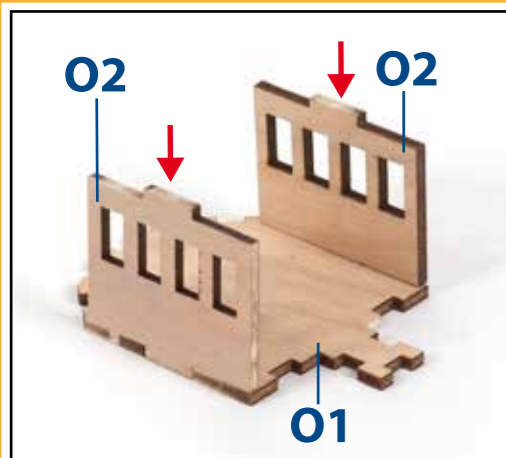

P

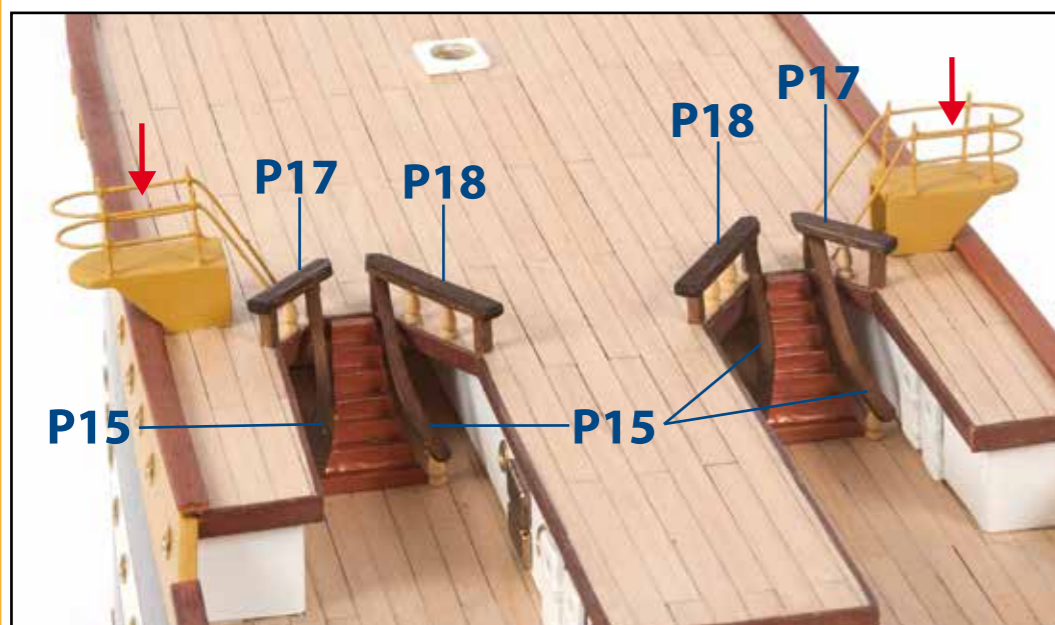
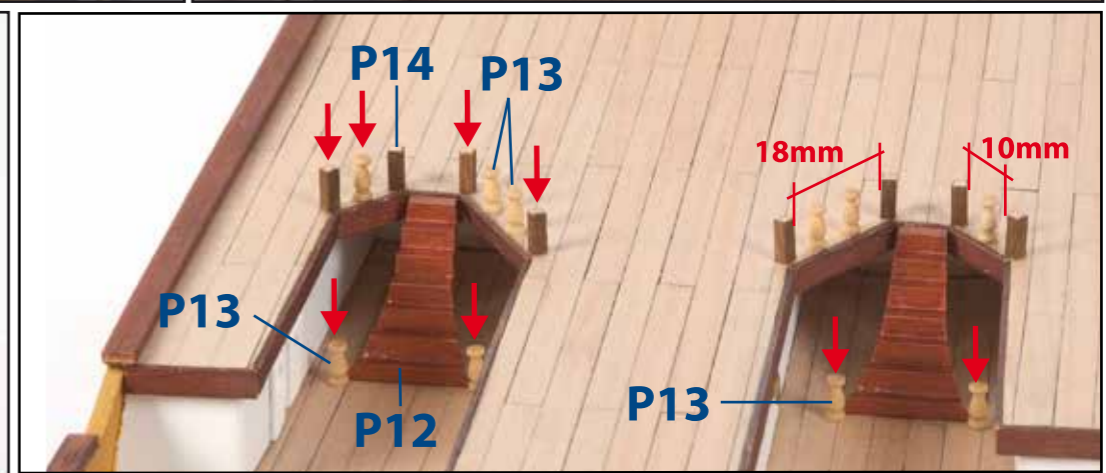
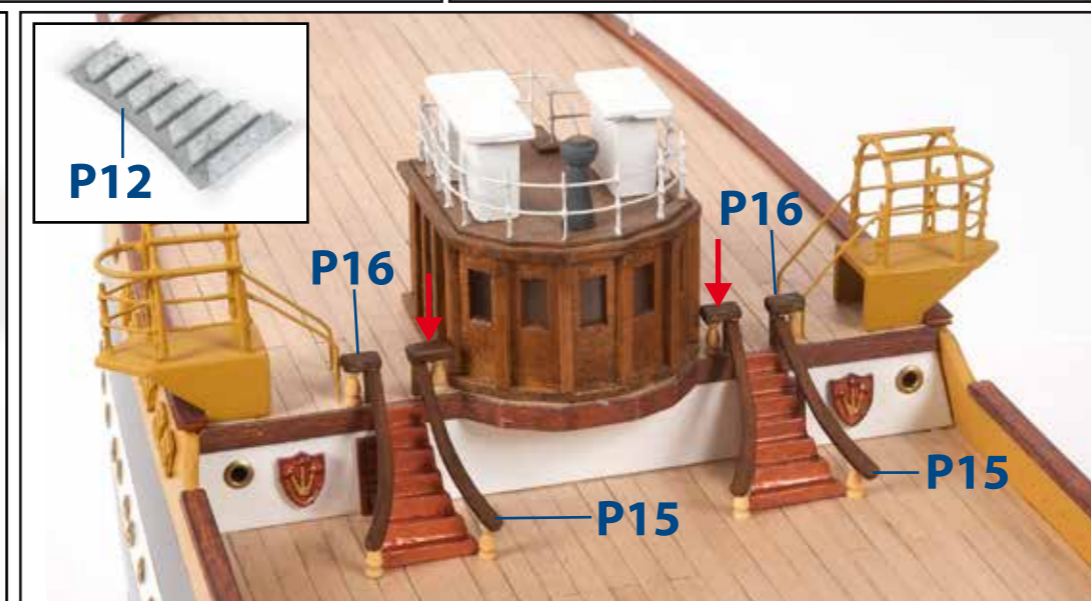
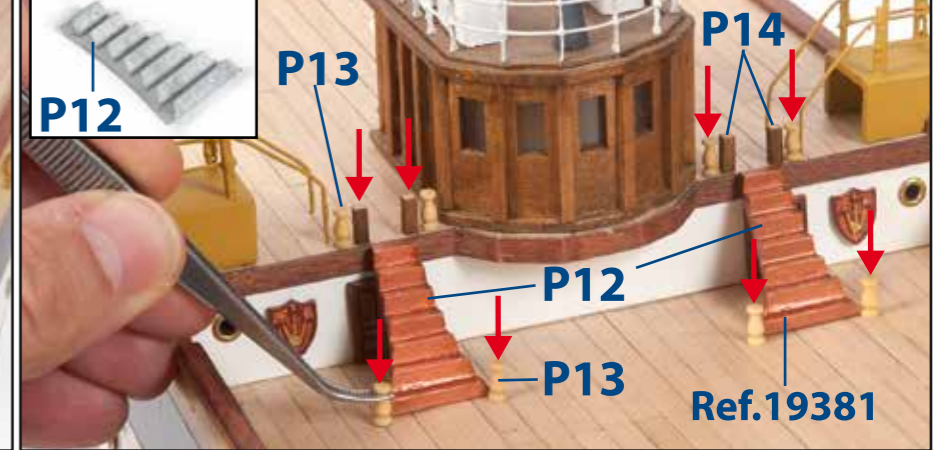
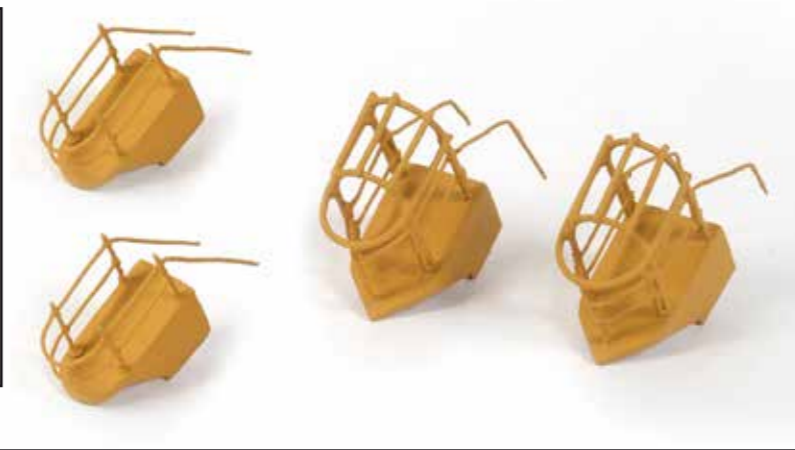
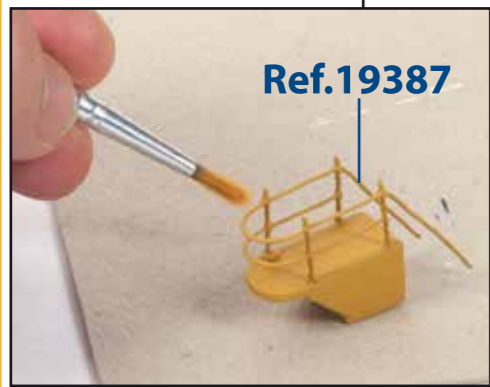
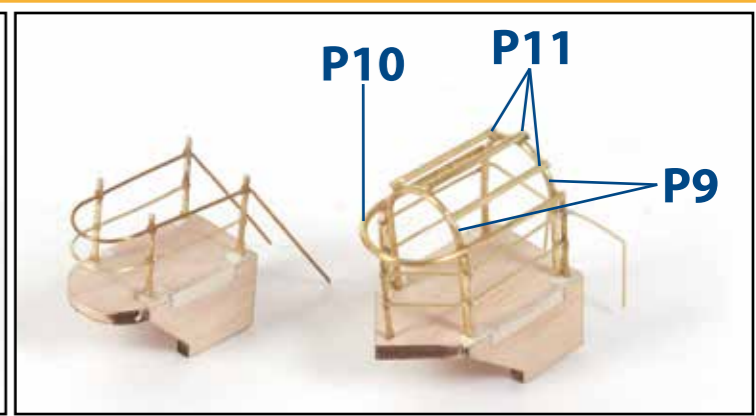
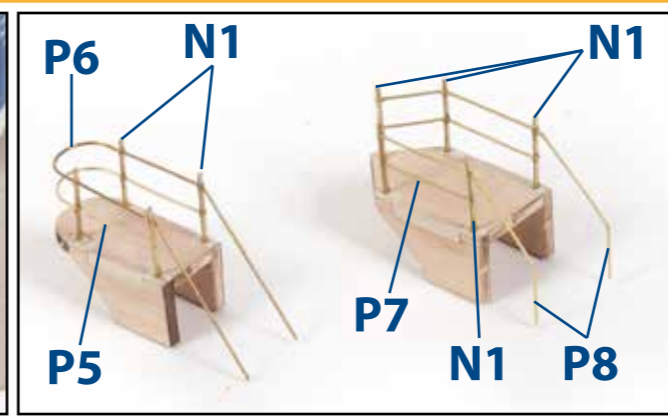
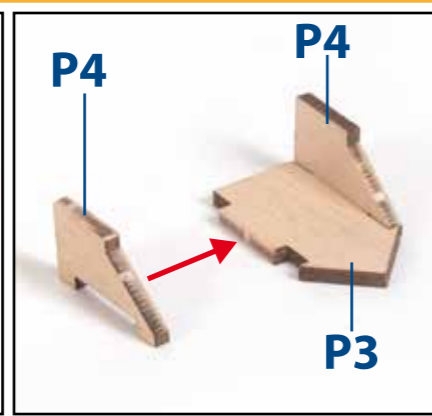
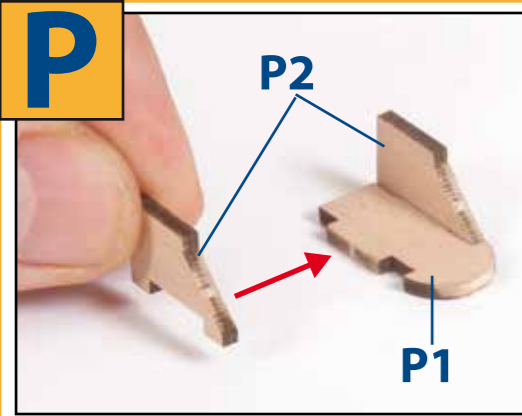

R

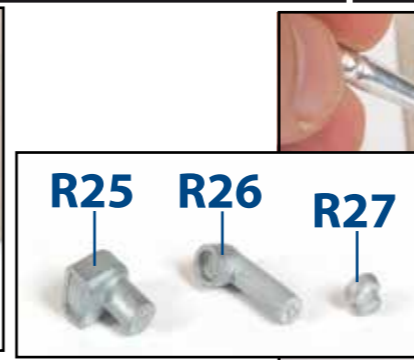
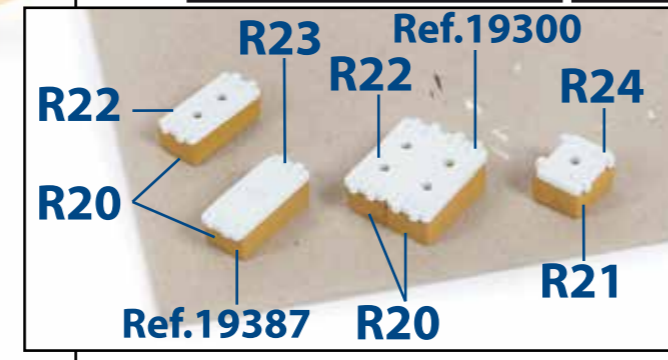
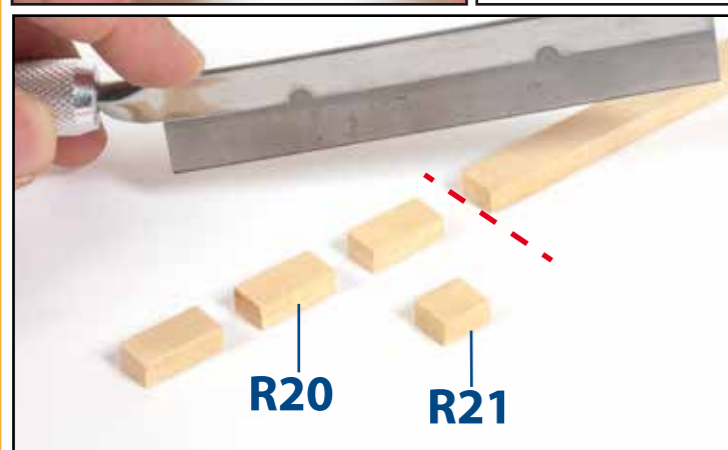
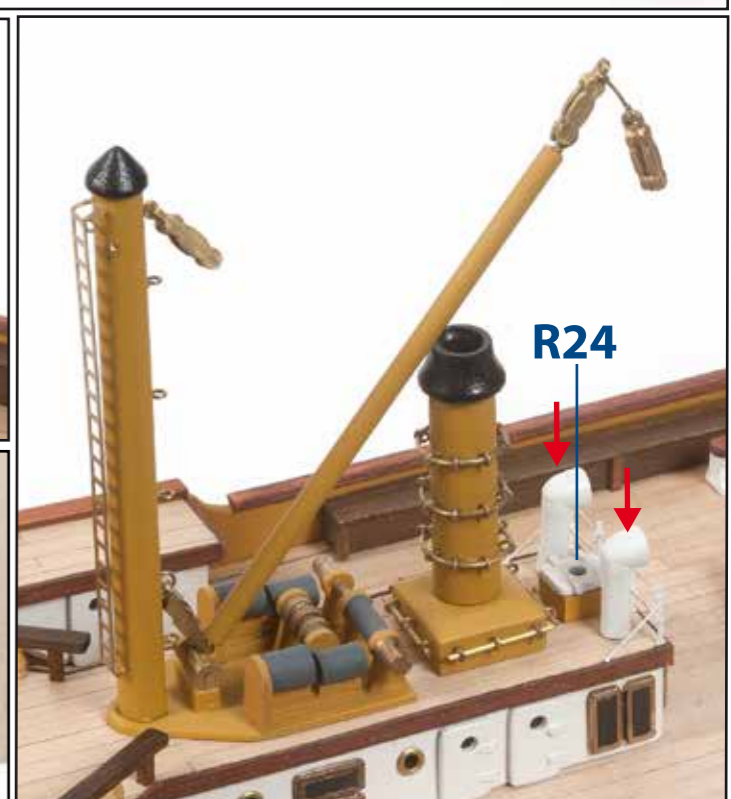
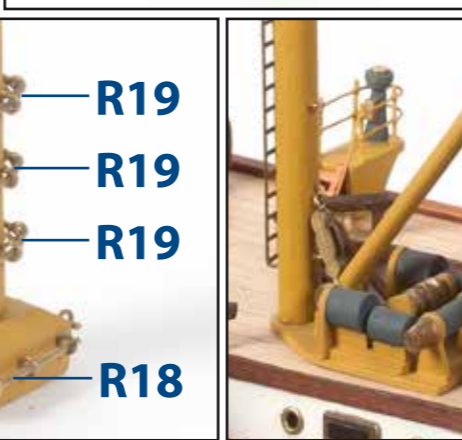
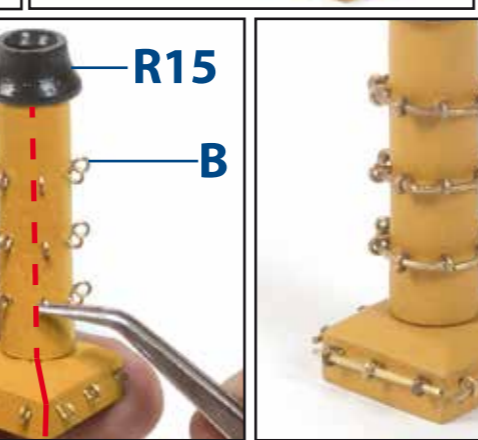
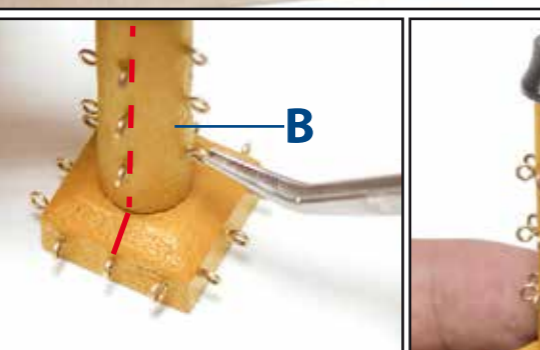
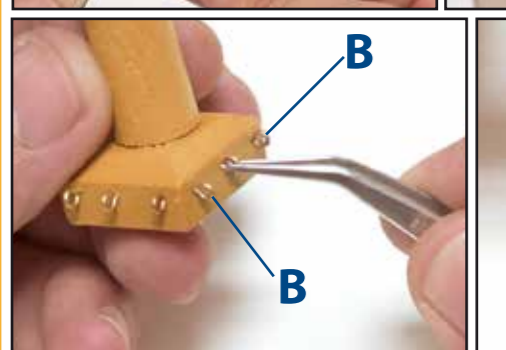
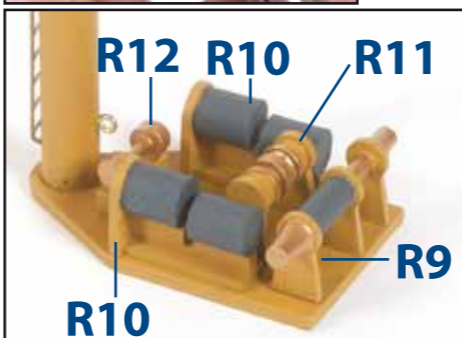
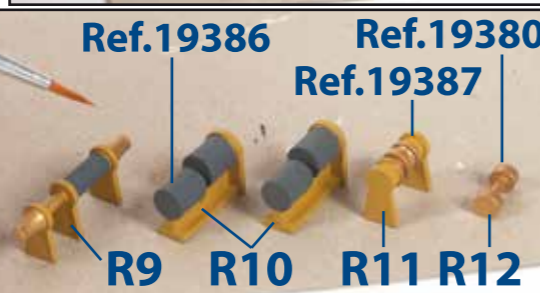
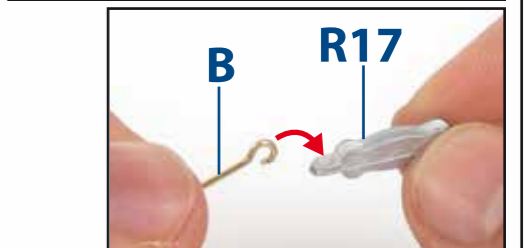
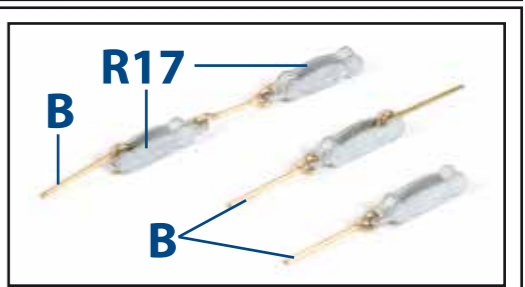
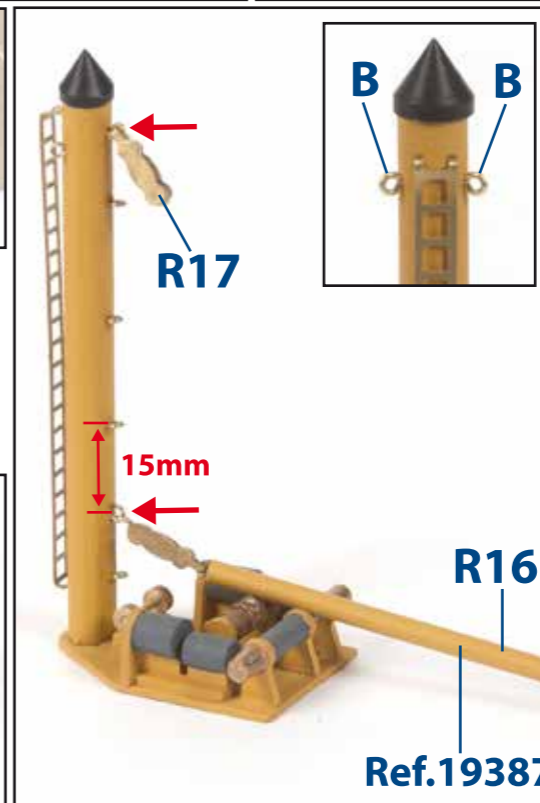
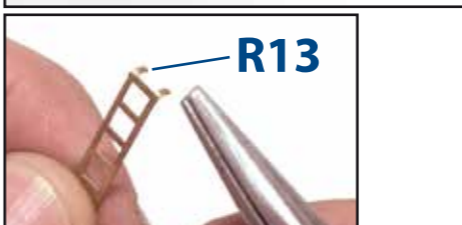
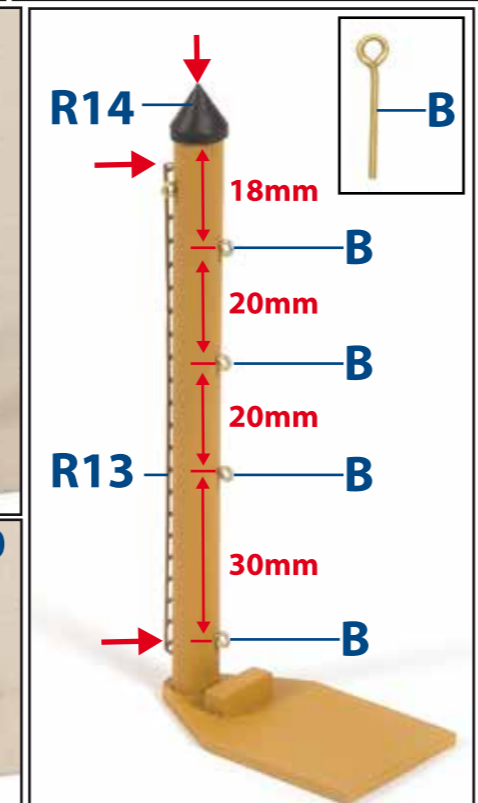
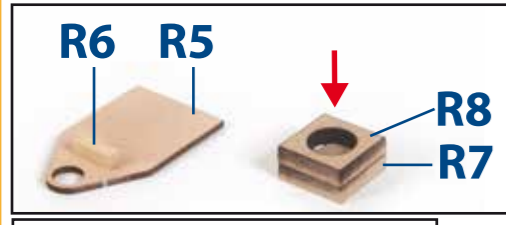
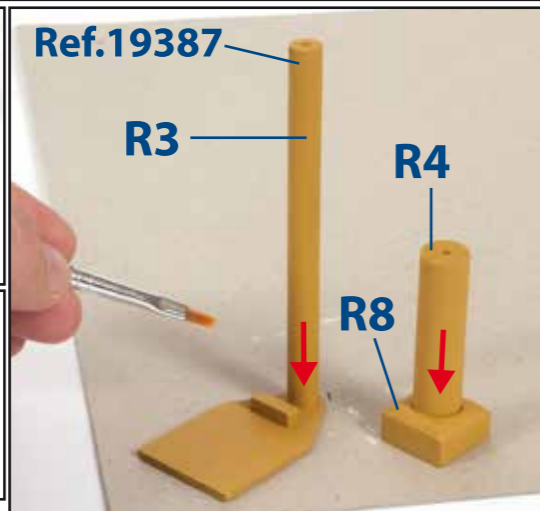
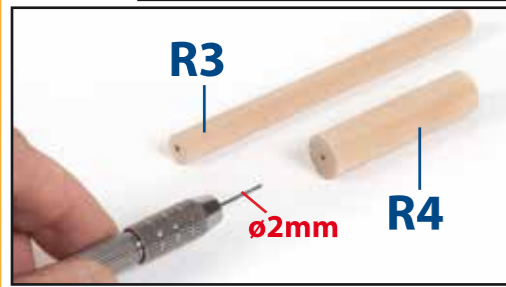
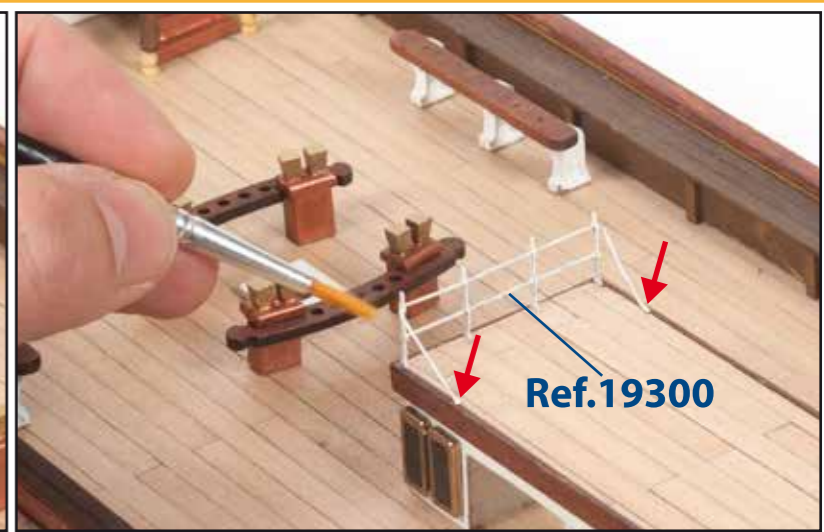
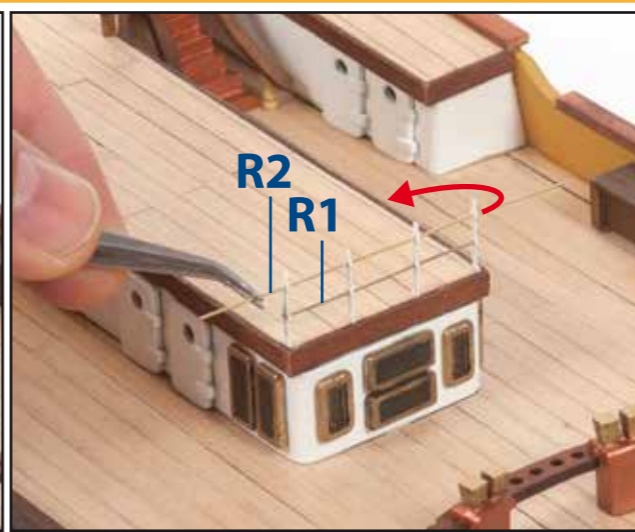
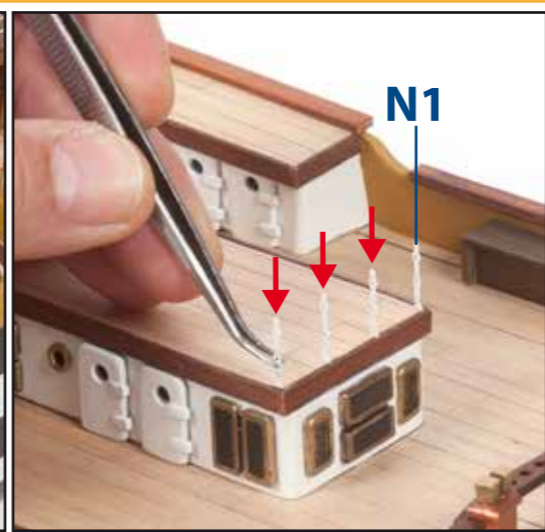
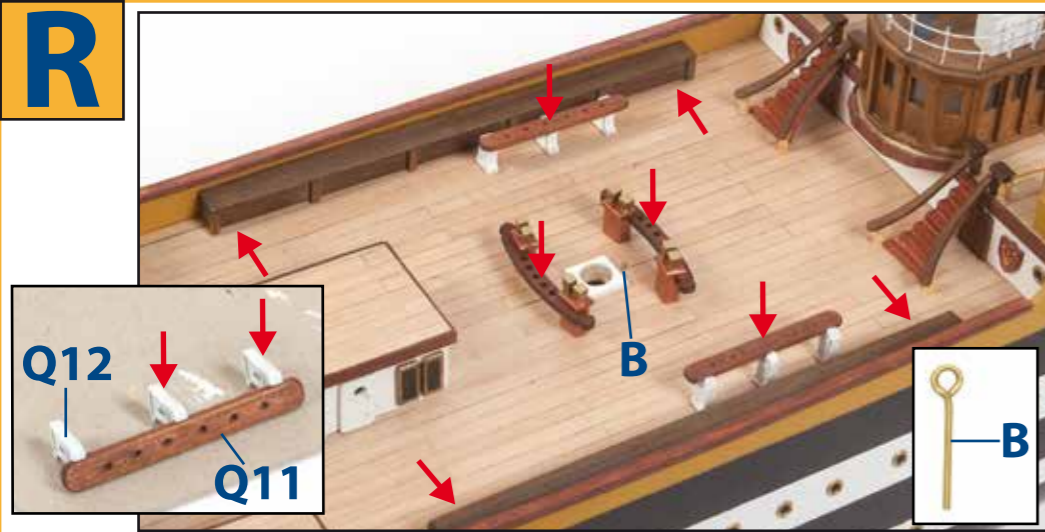

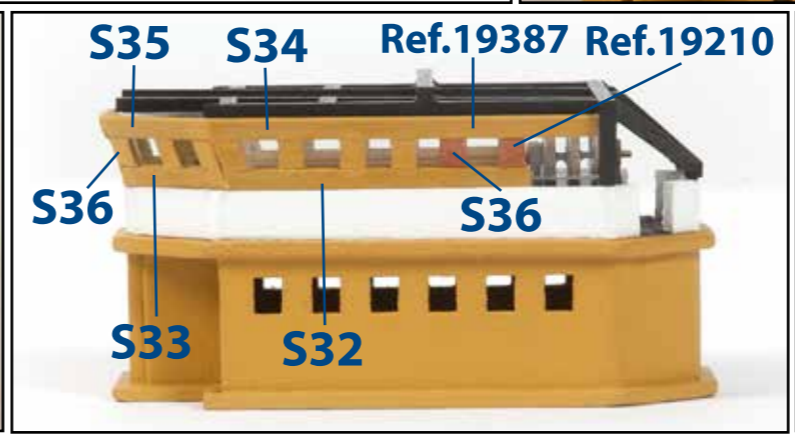
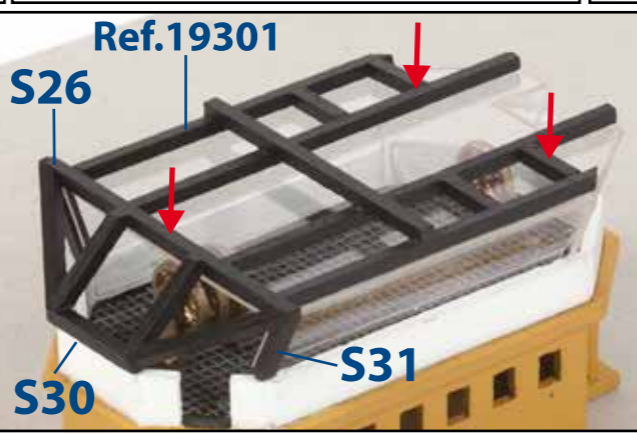
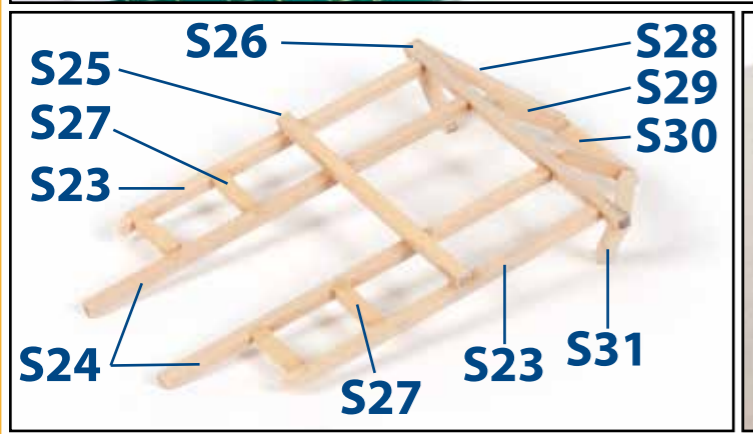
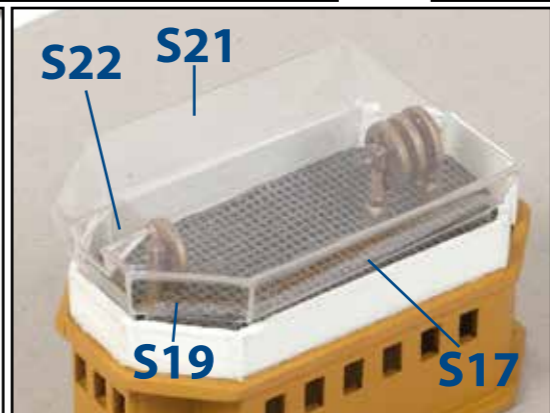
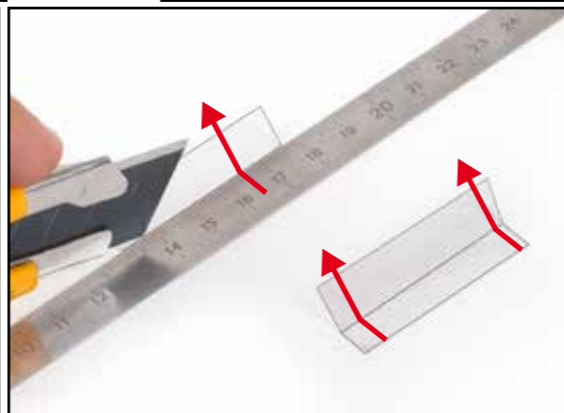
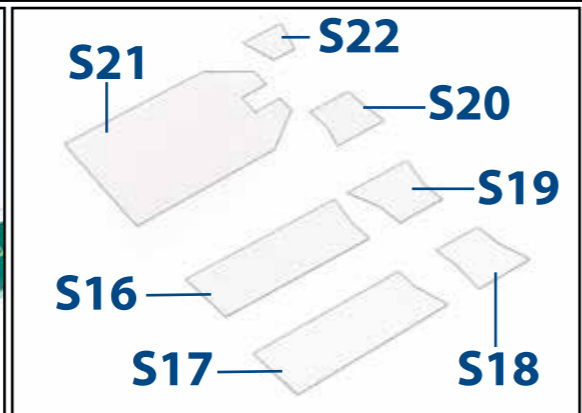
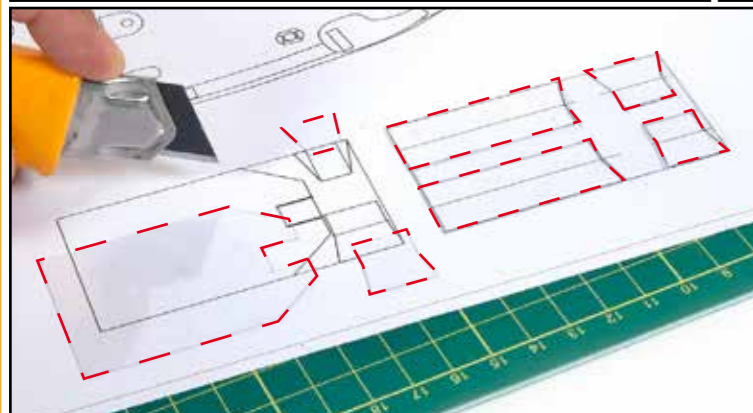
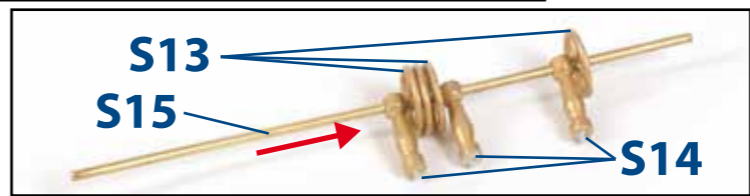
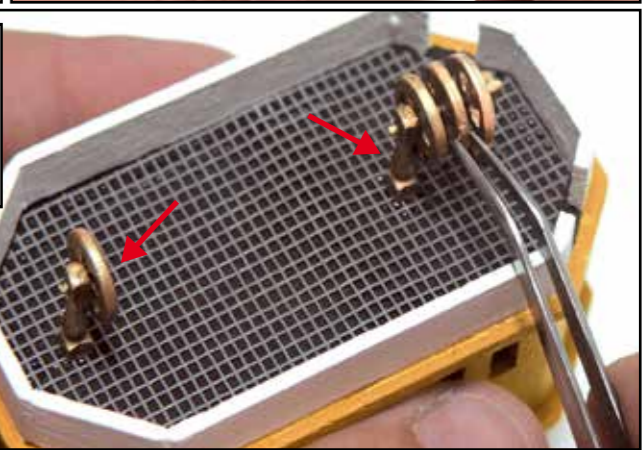
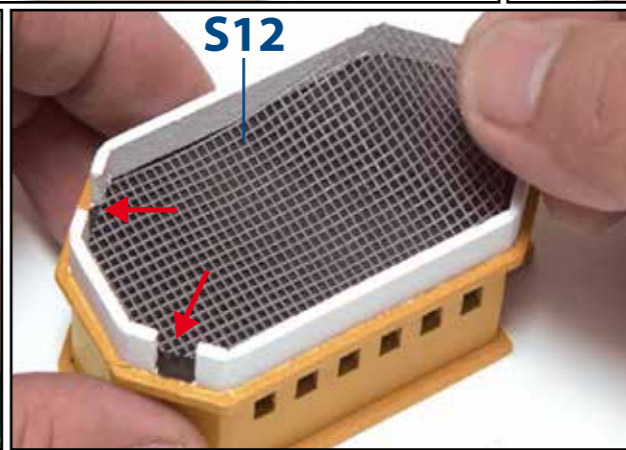
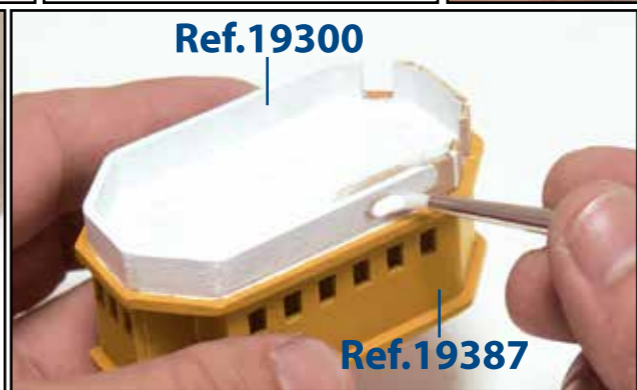
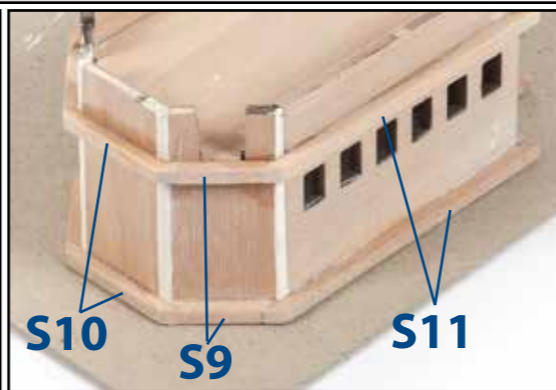
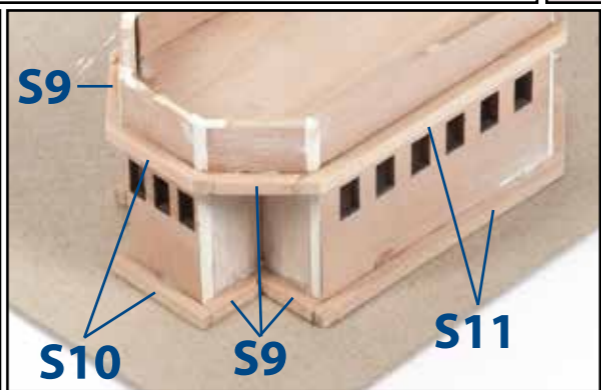
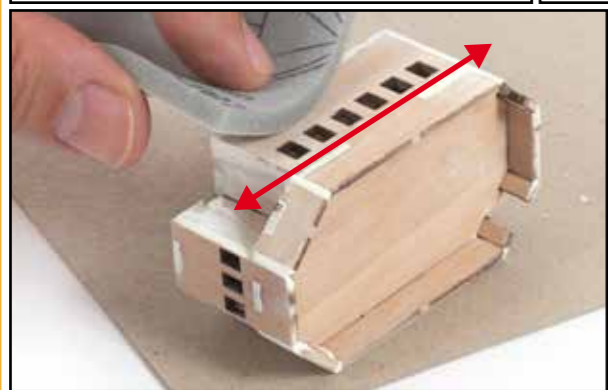
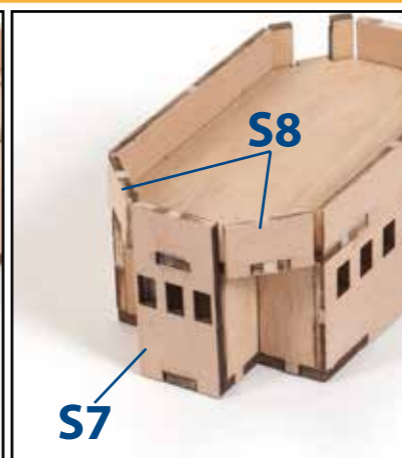
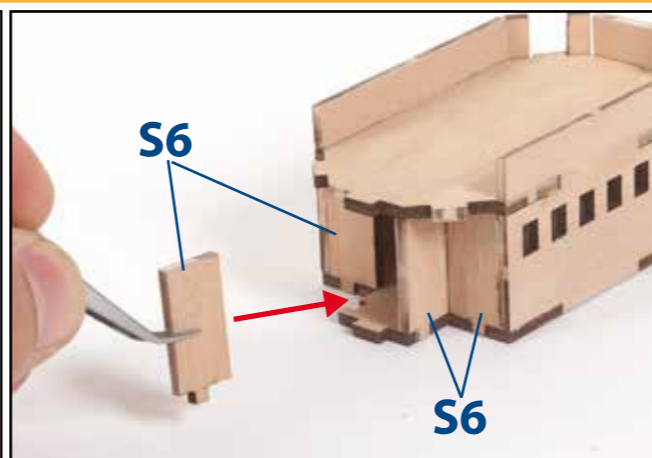
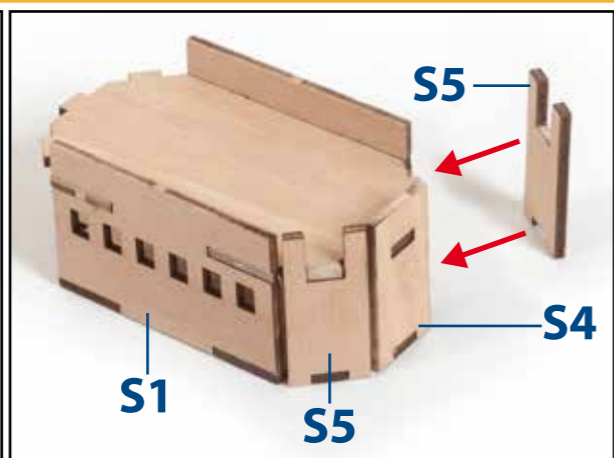
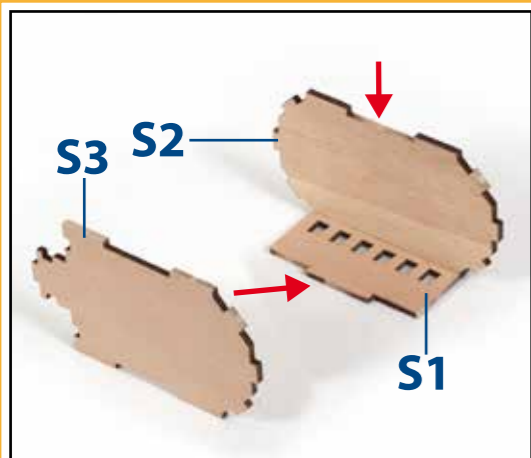

T

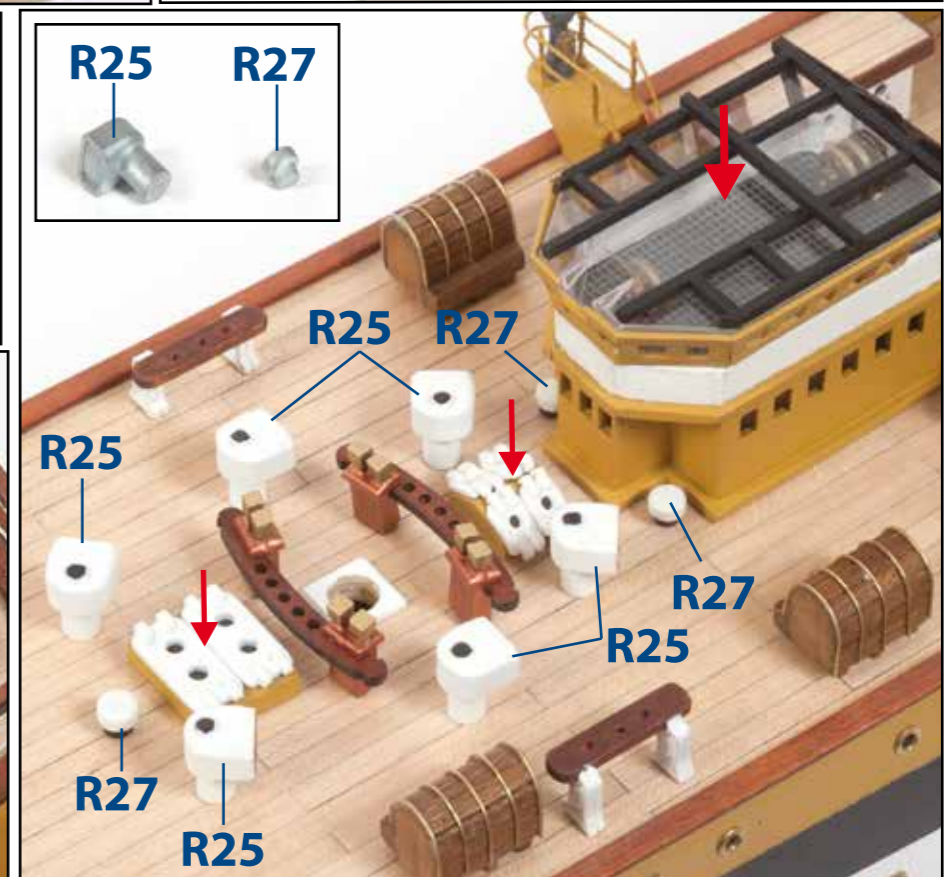
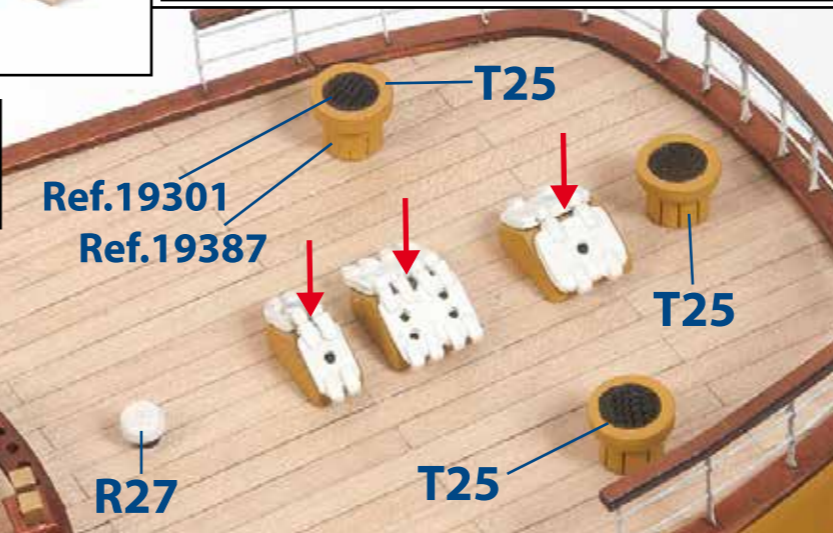
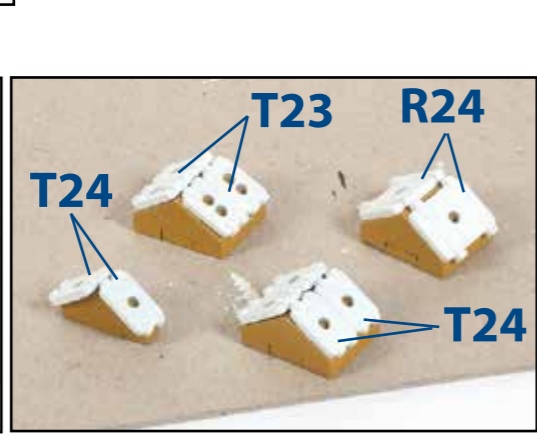
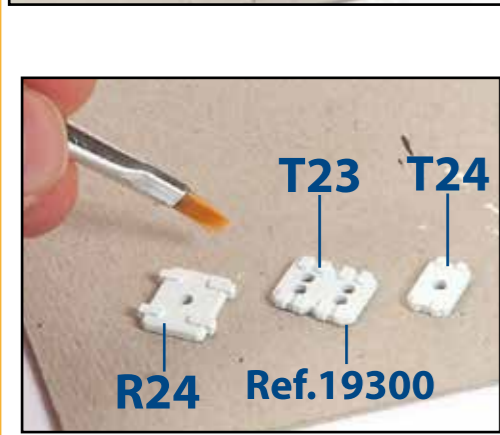
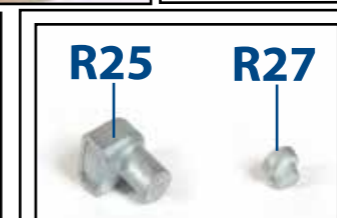
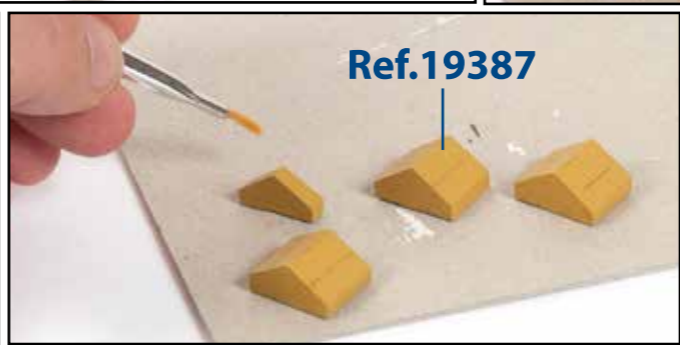
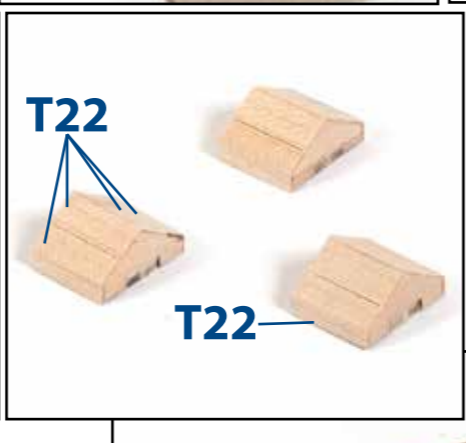
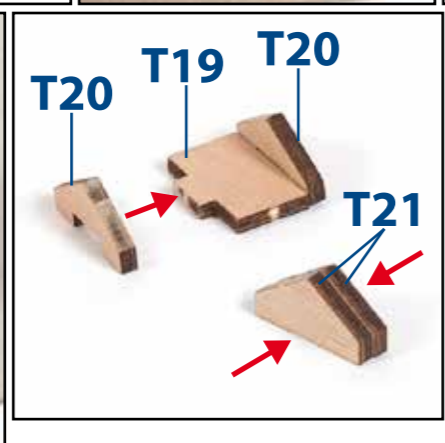
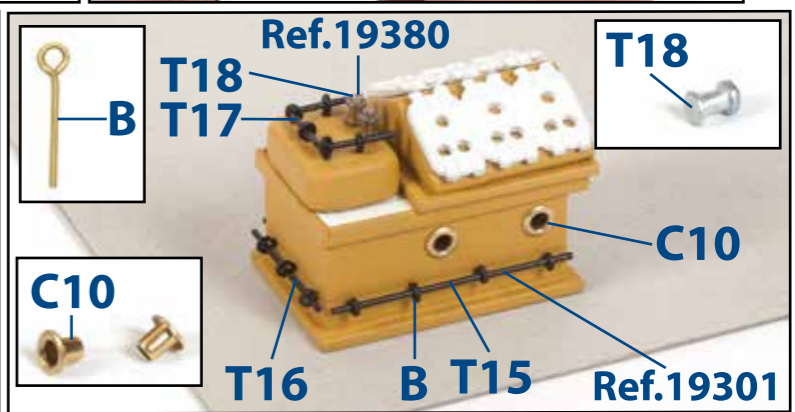
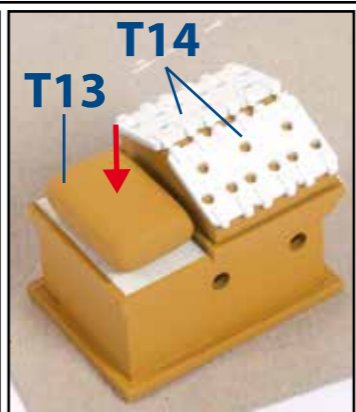
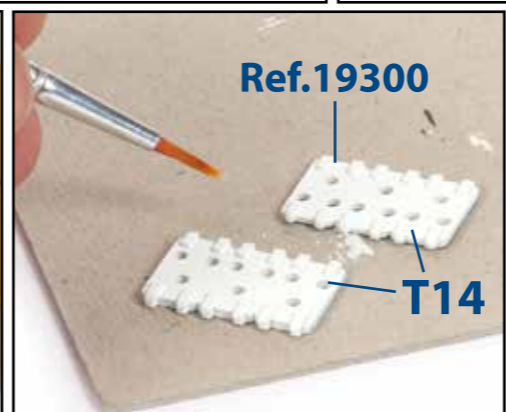
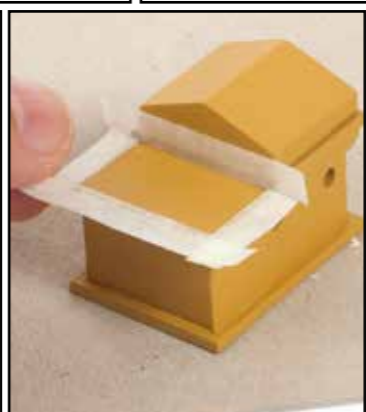
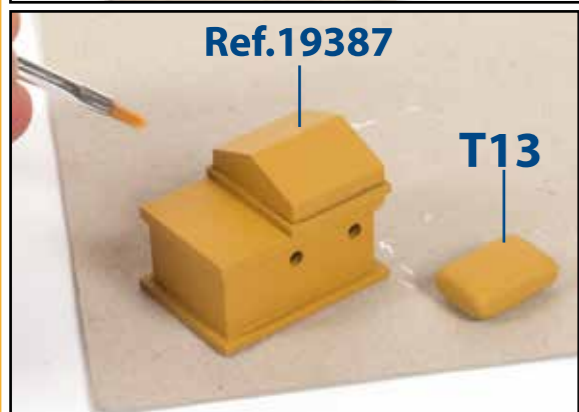
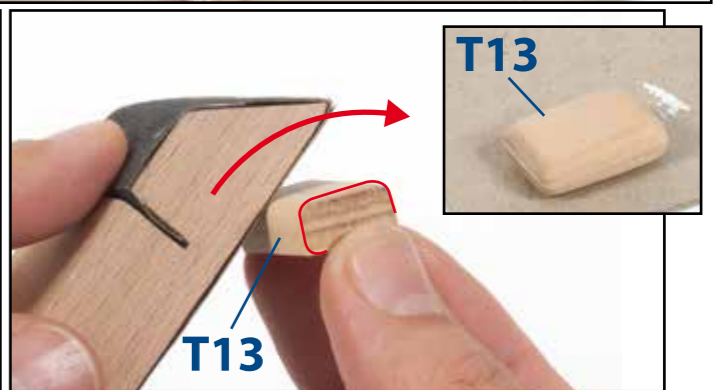
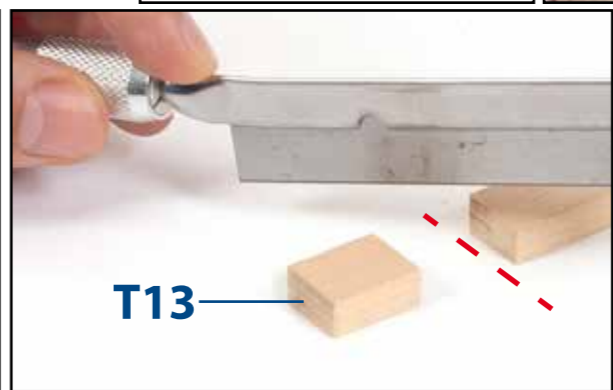
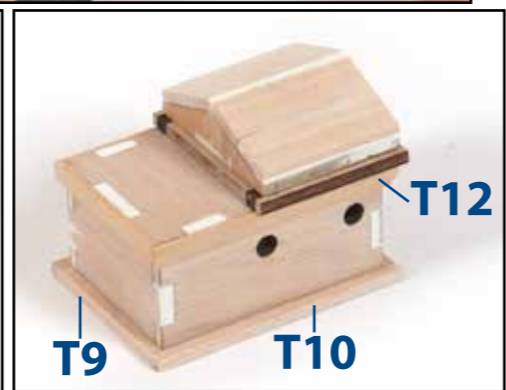
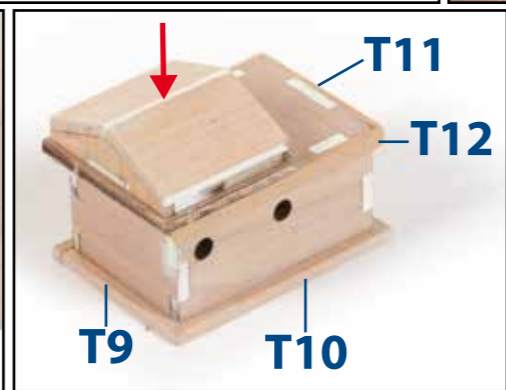
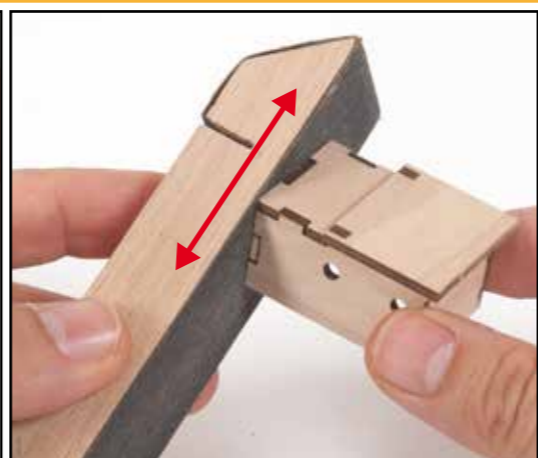
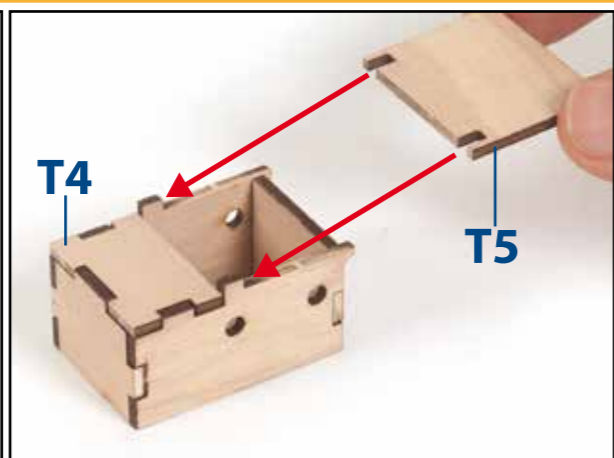
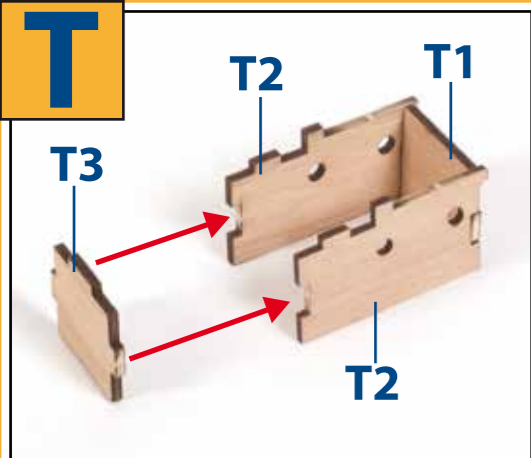

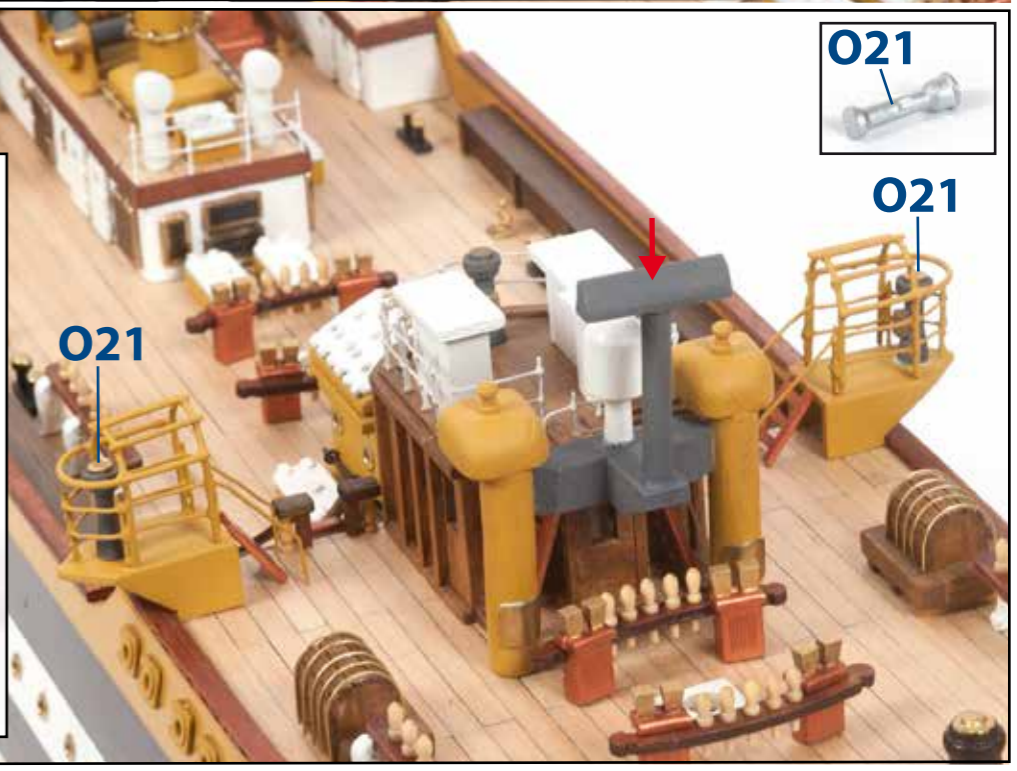
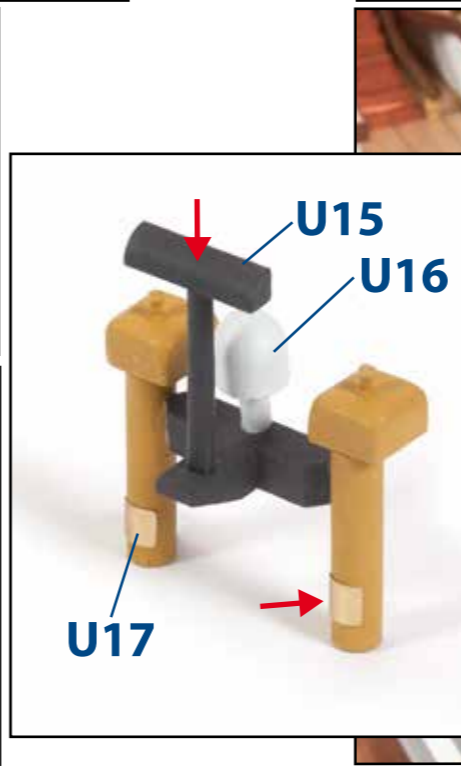
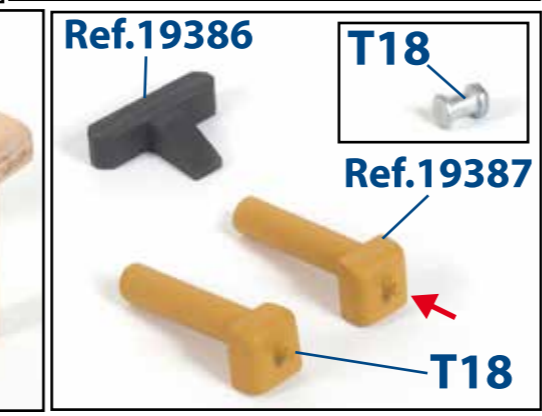
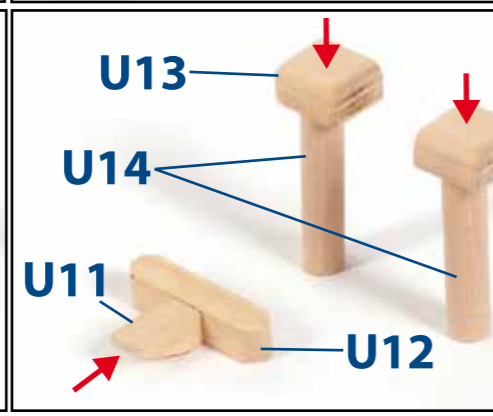
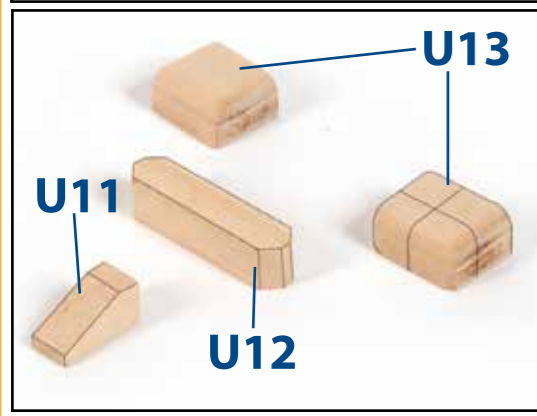
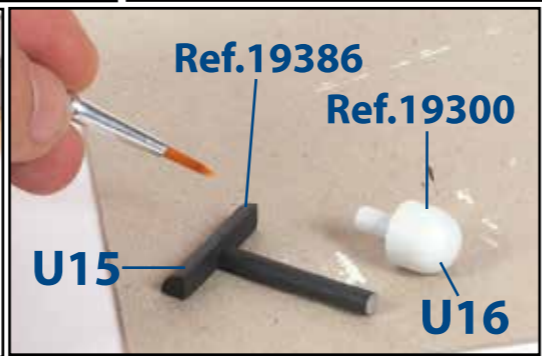
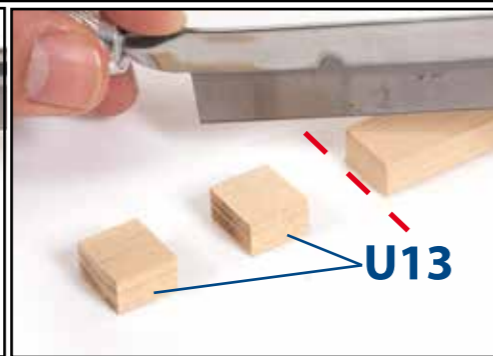
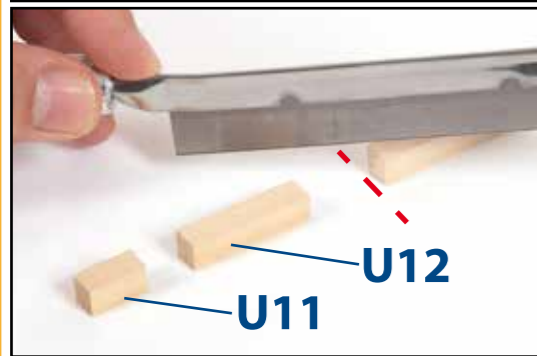
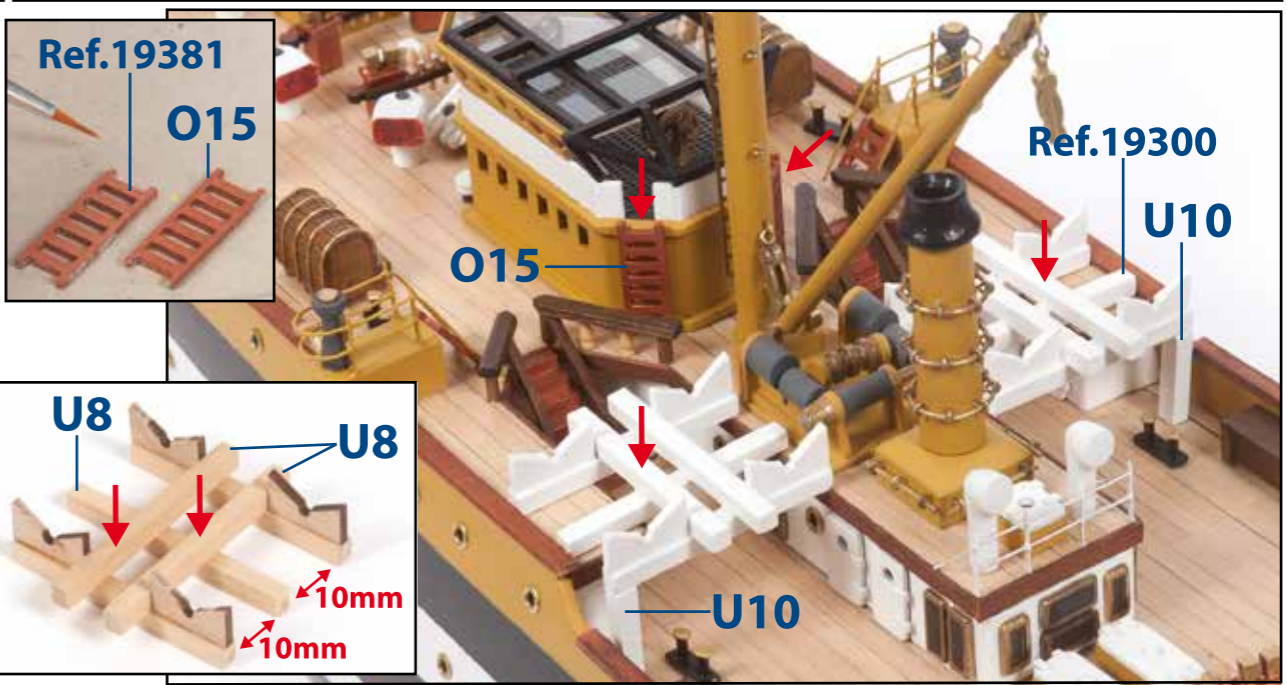
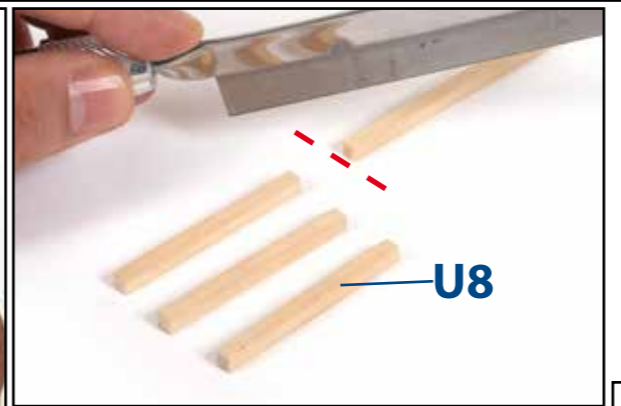
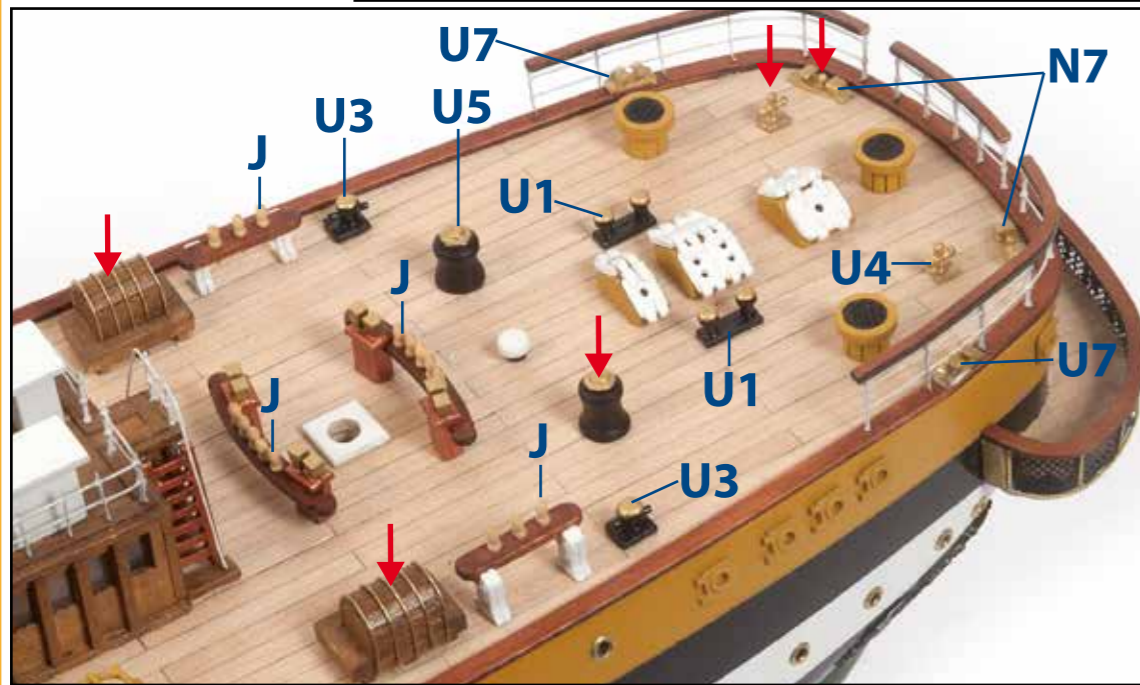
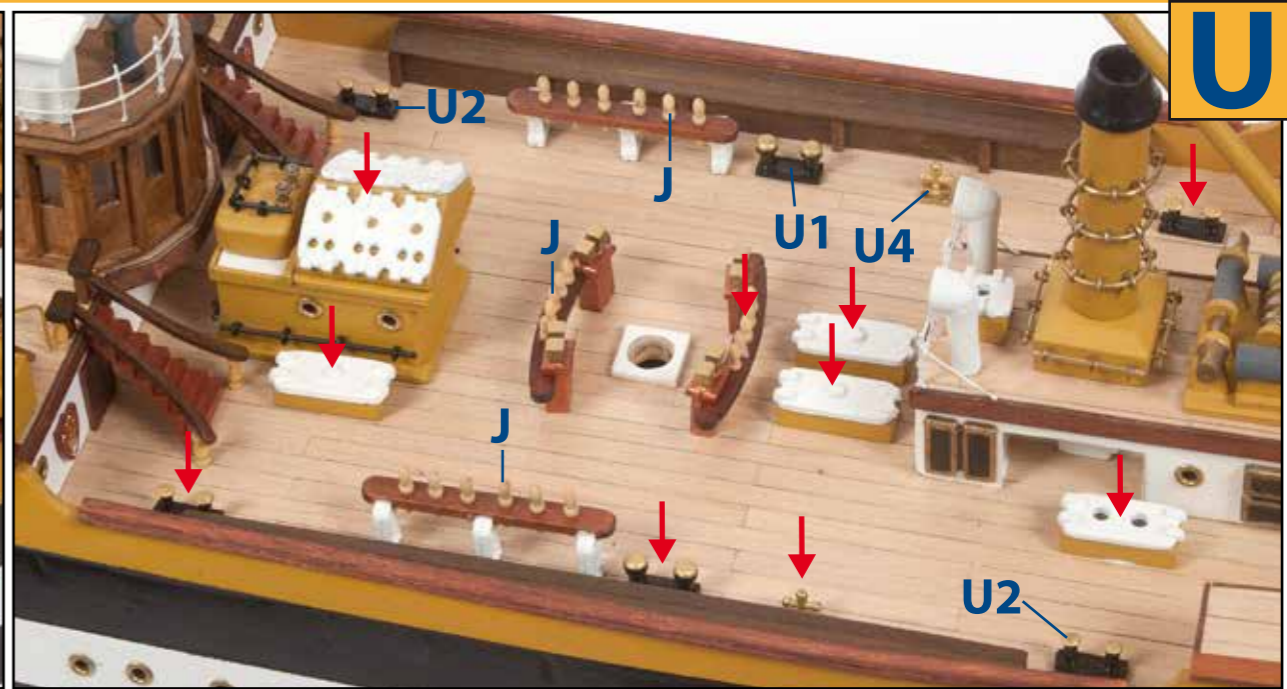
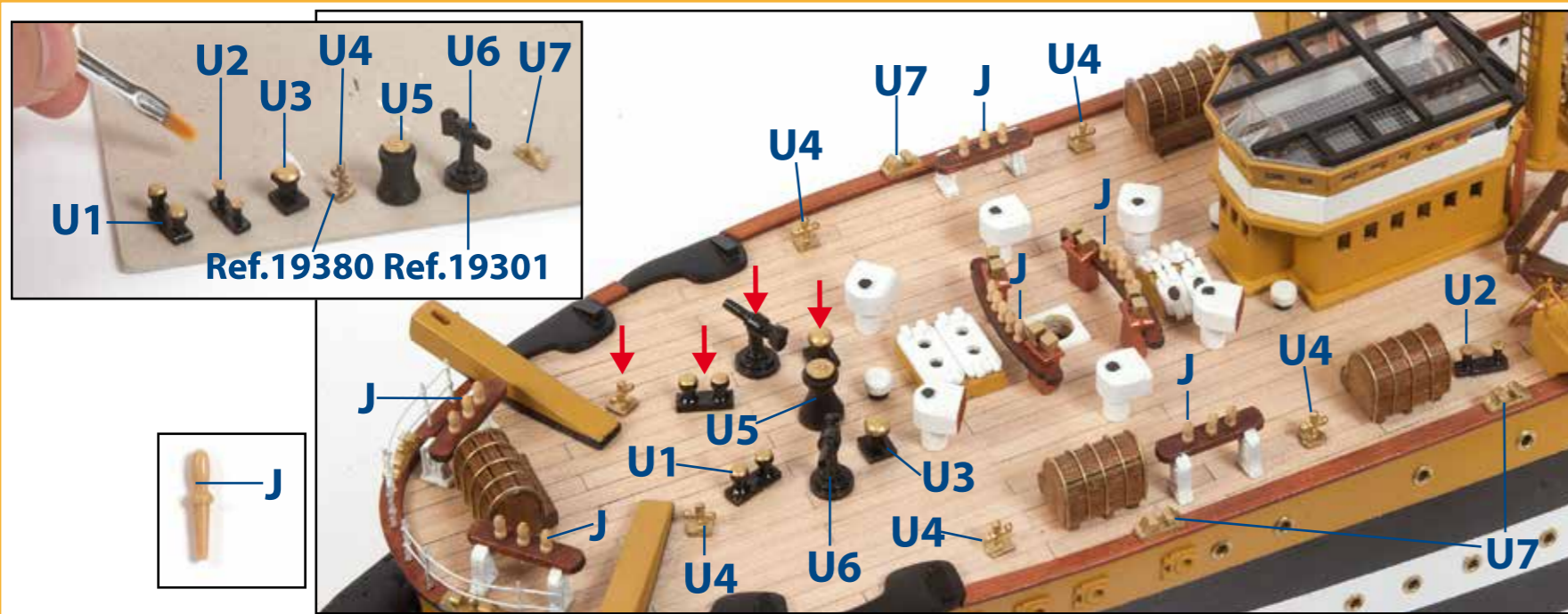

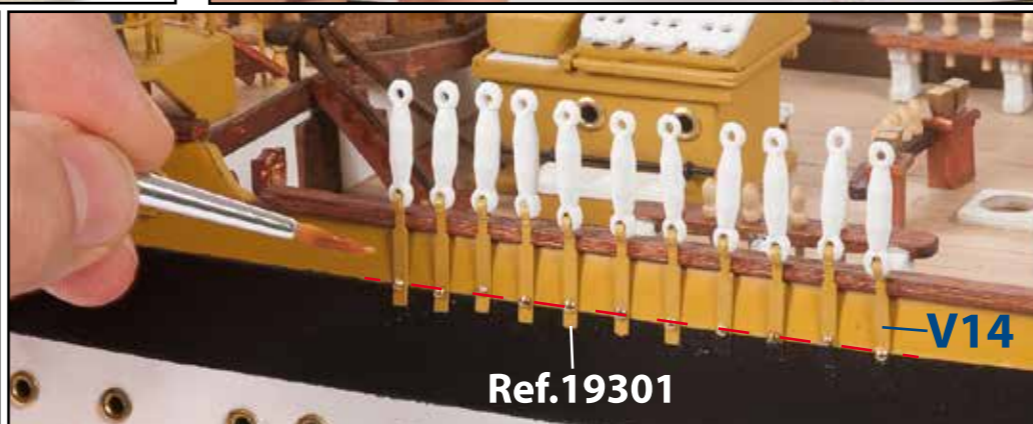
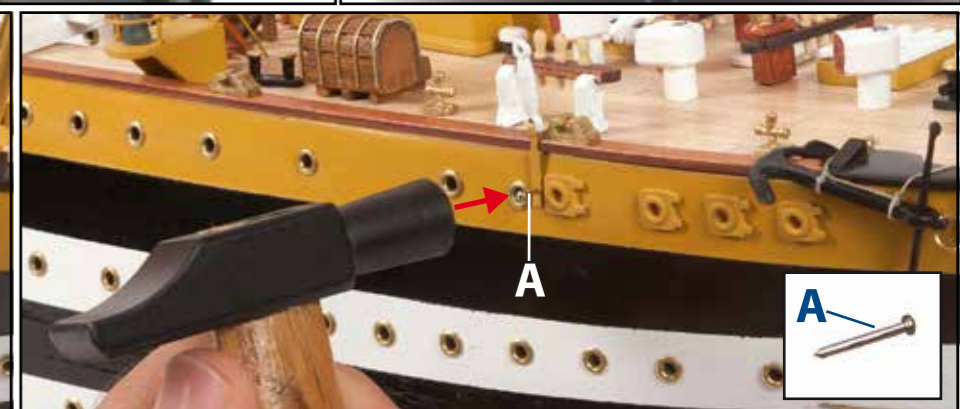
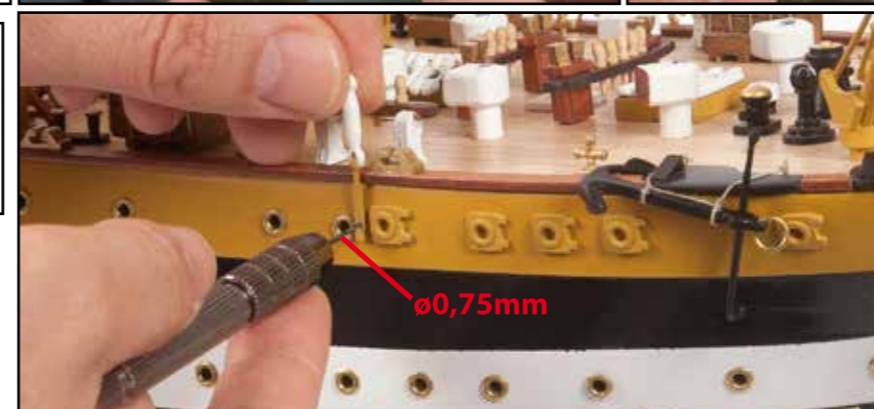
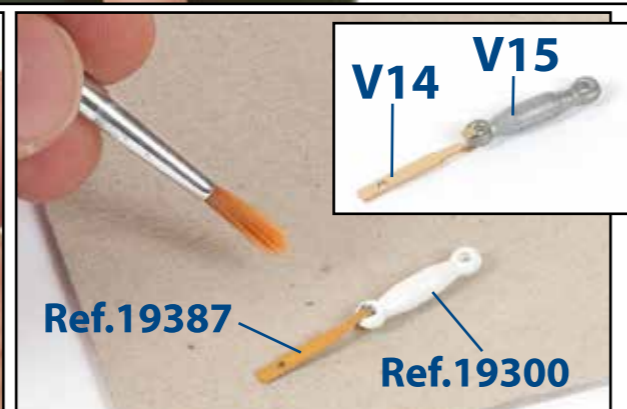
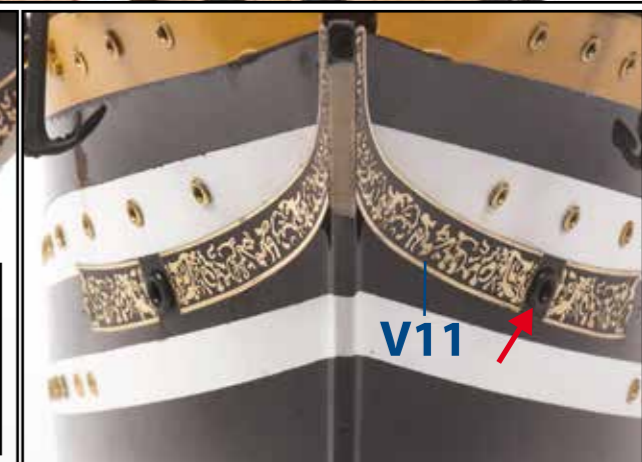
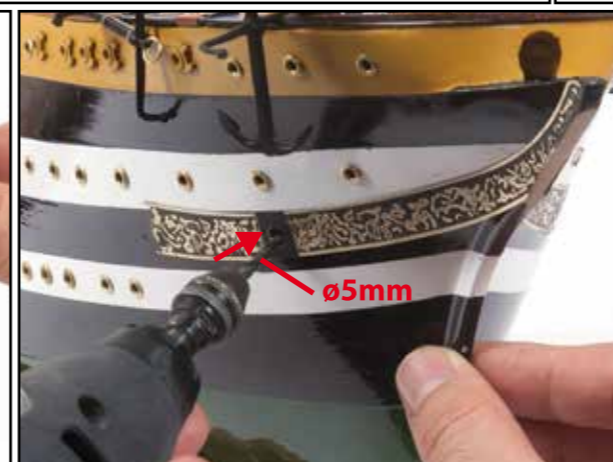
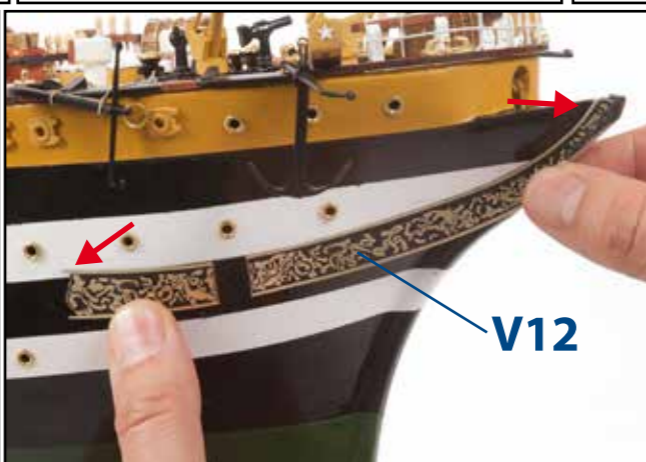
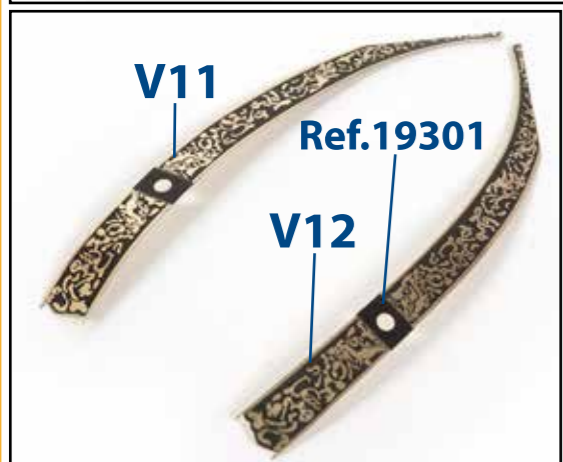
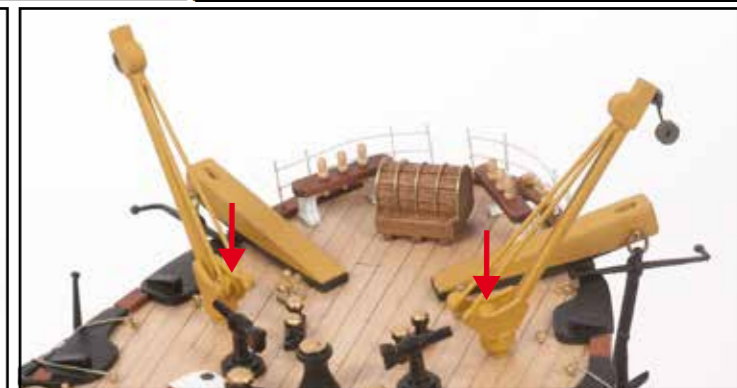
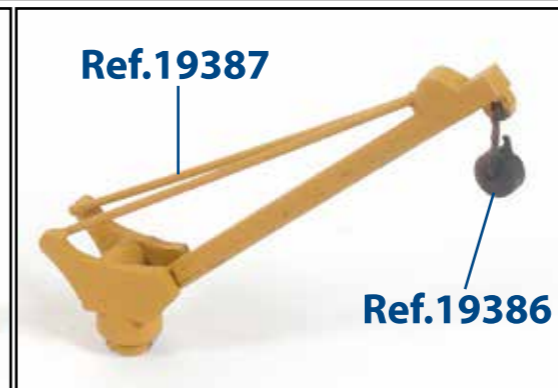
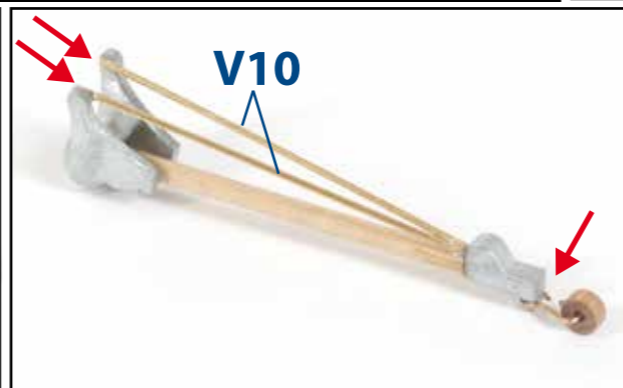
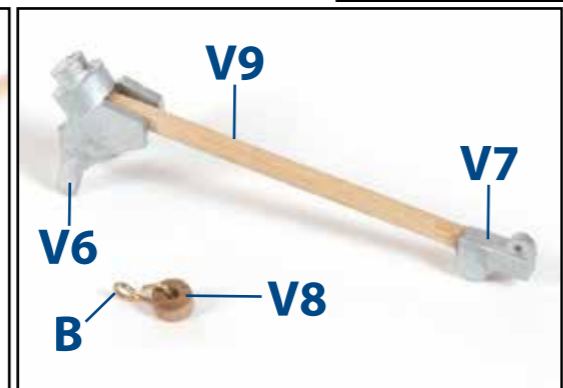
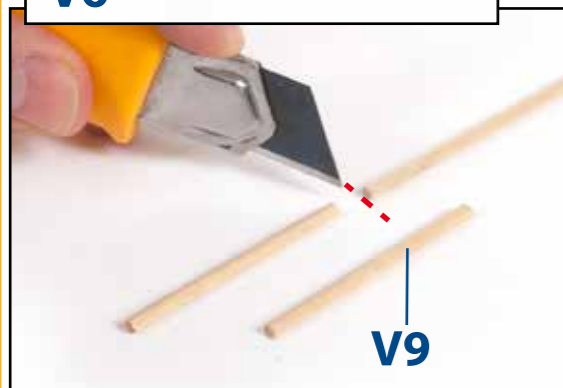
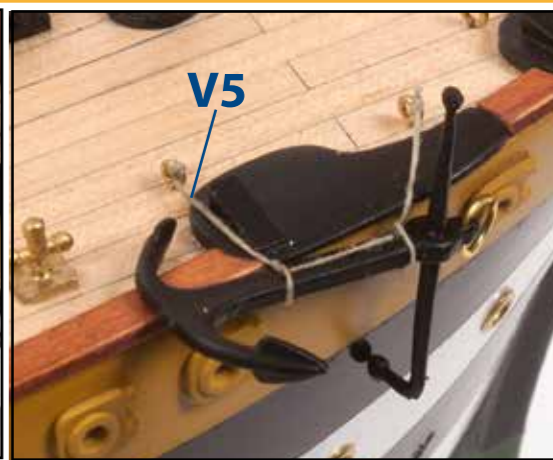
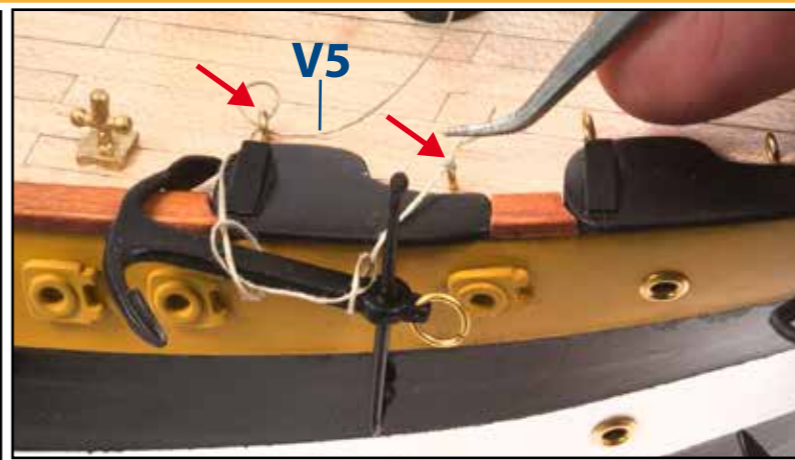
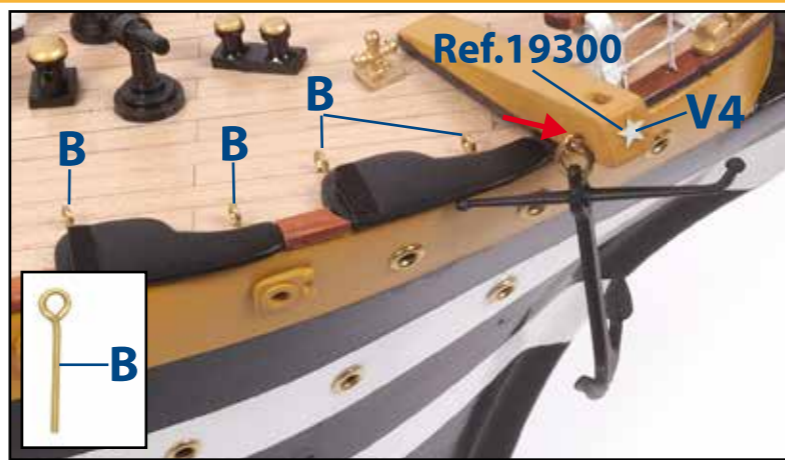
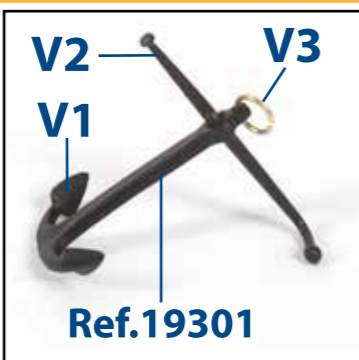
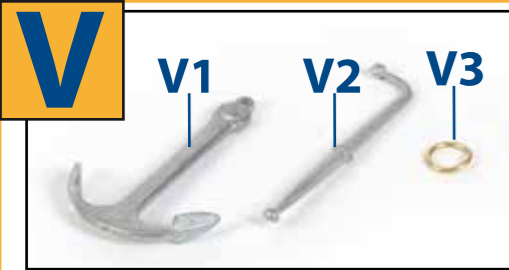

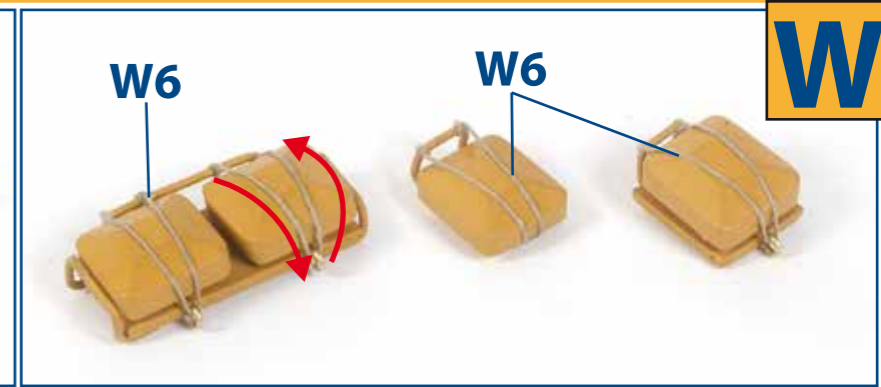
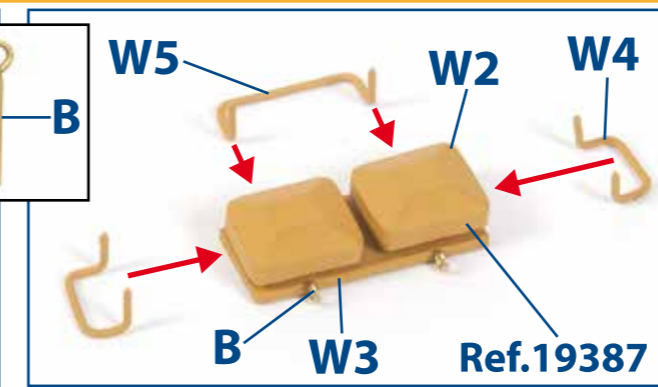
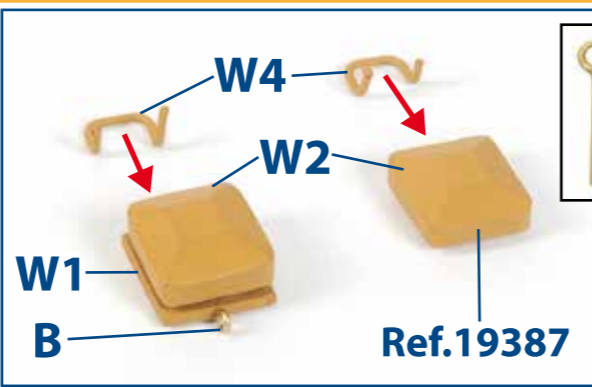
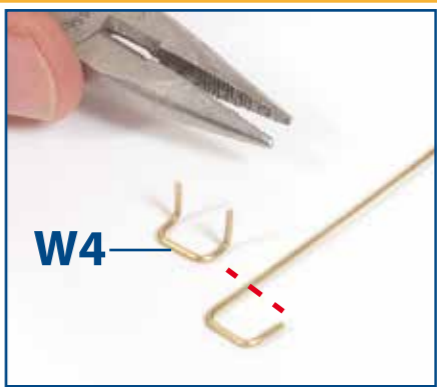

W

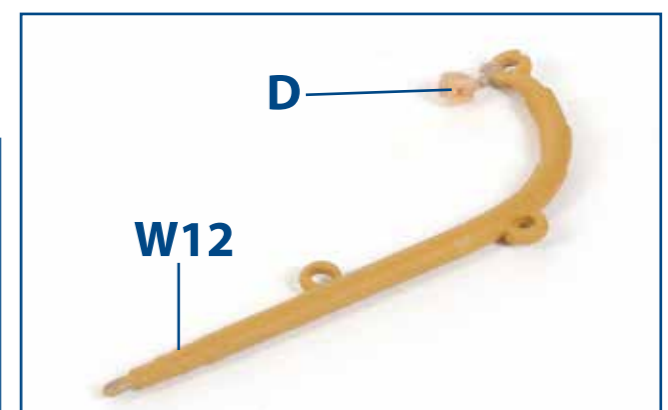
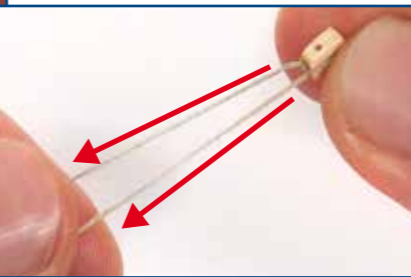
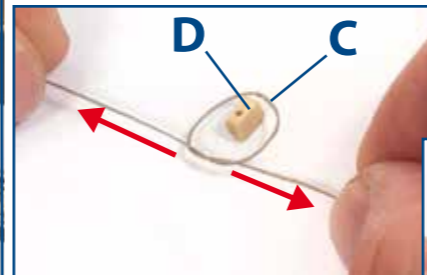
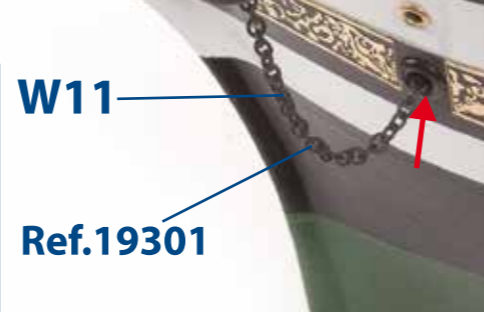
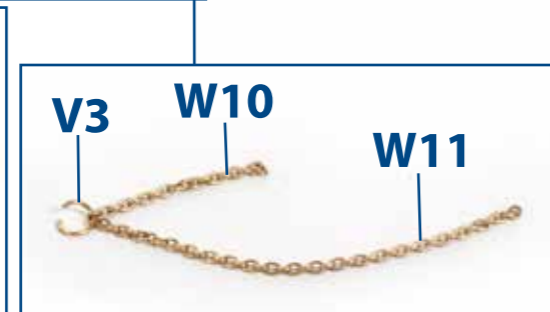
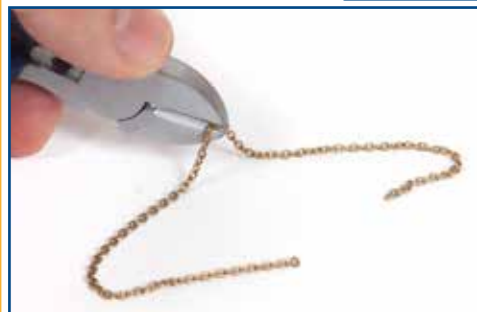
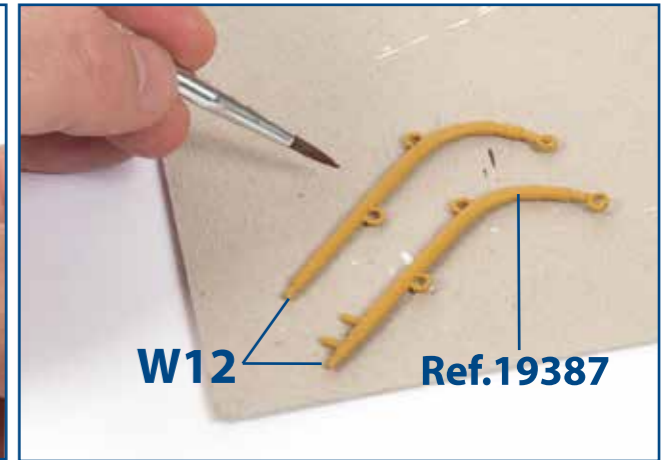
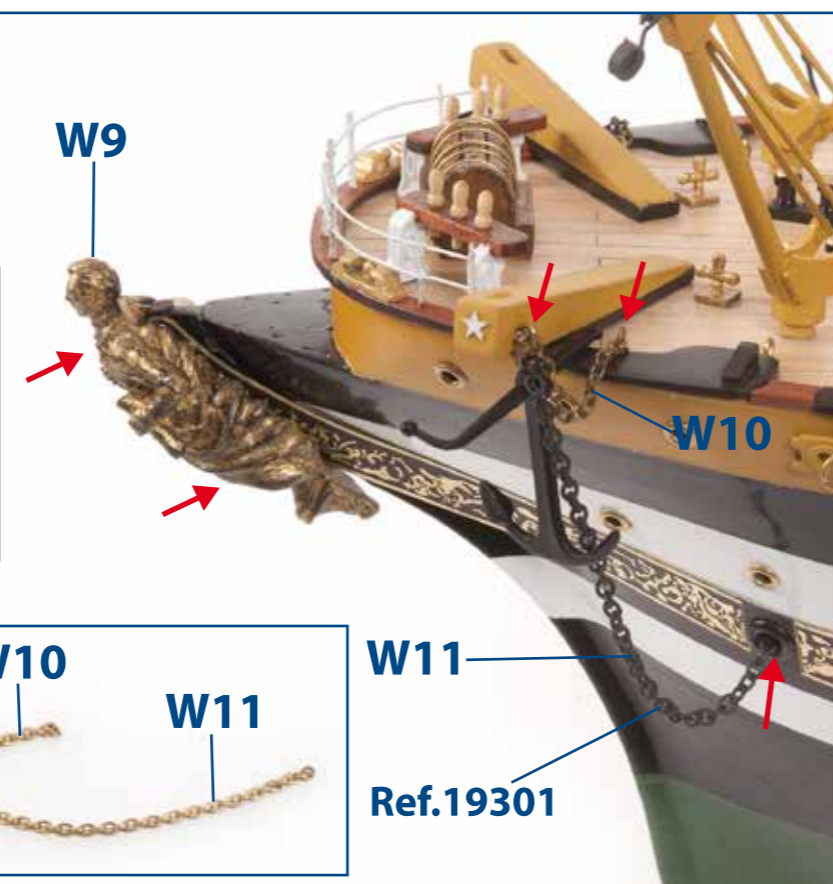
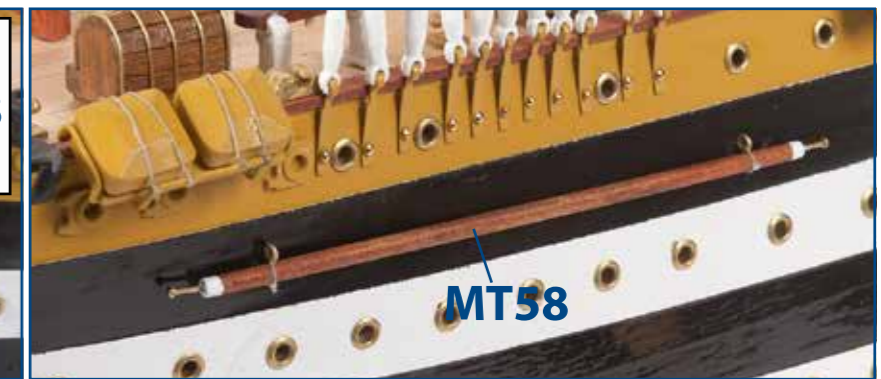
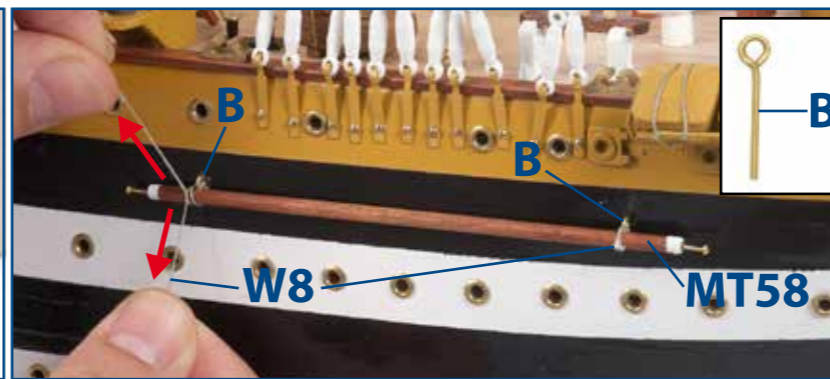
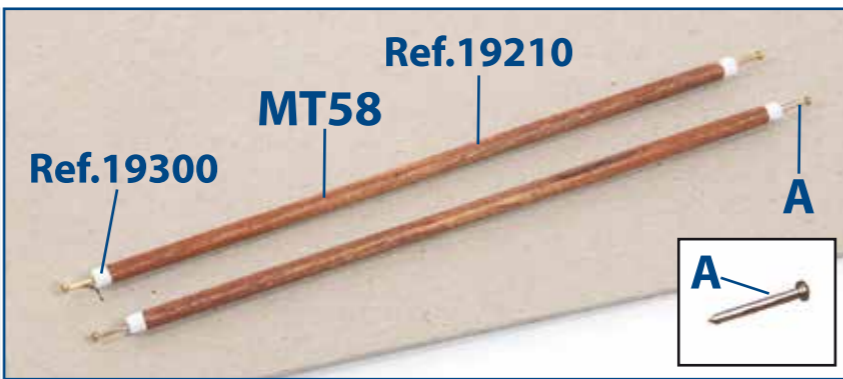
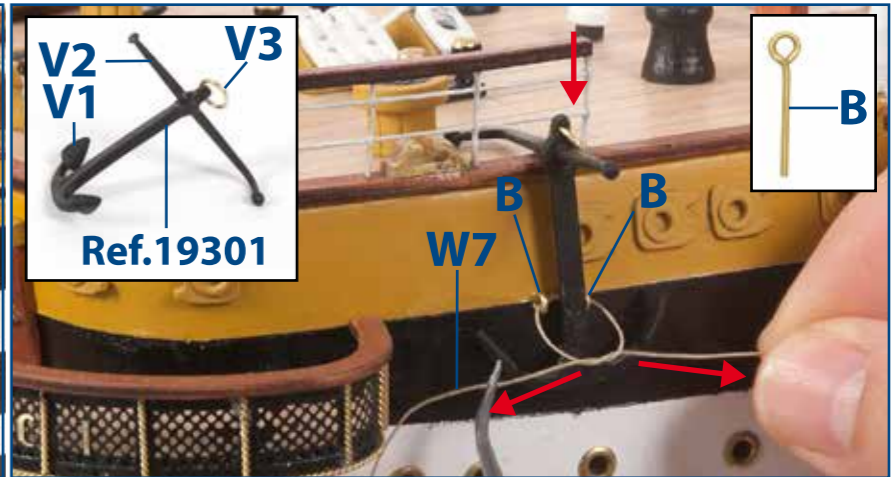
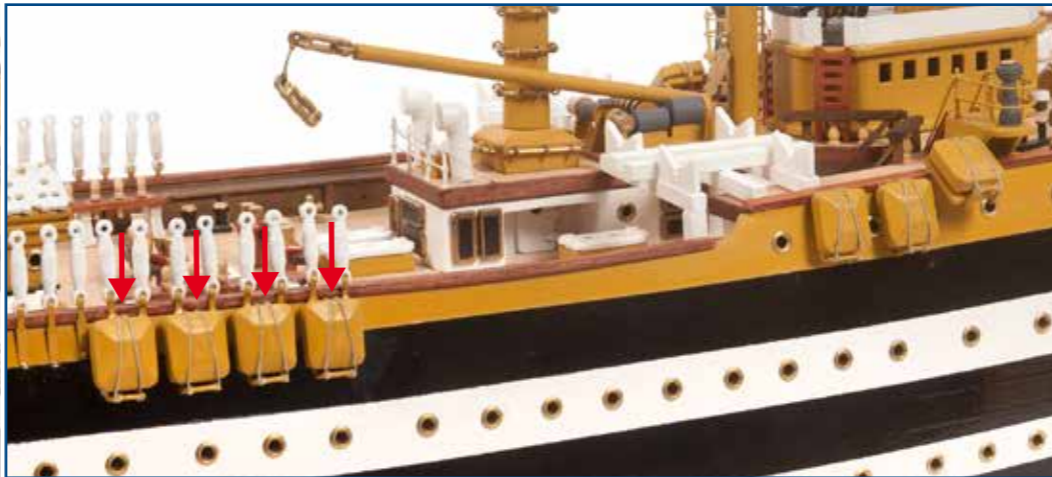

X

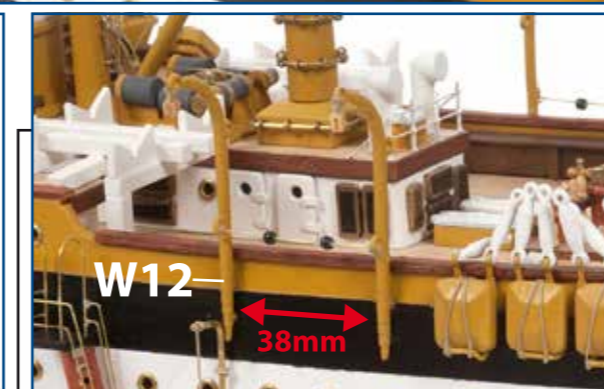
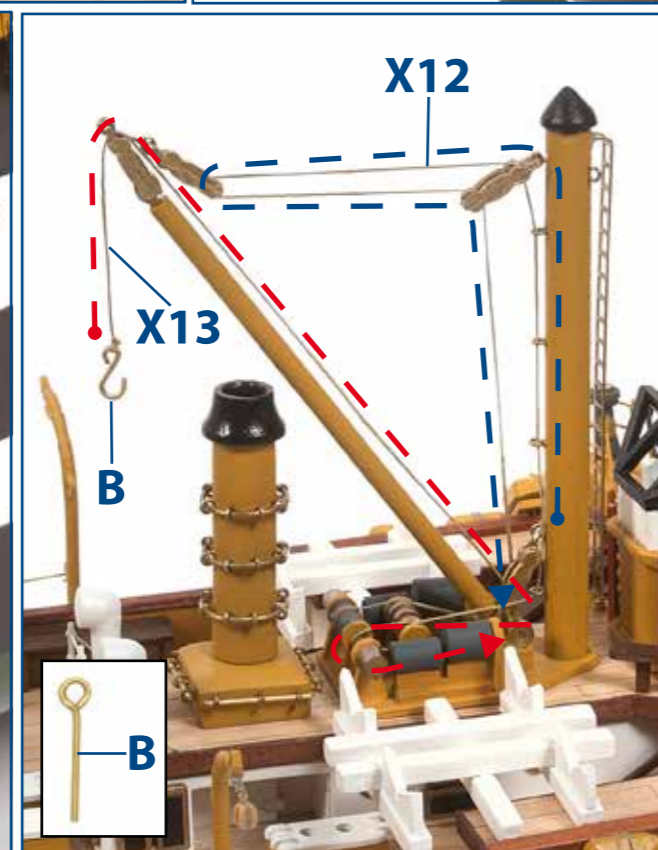
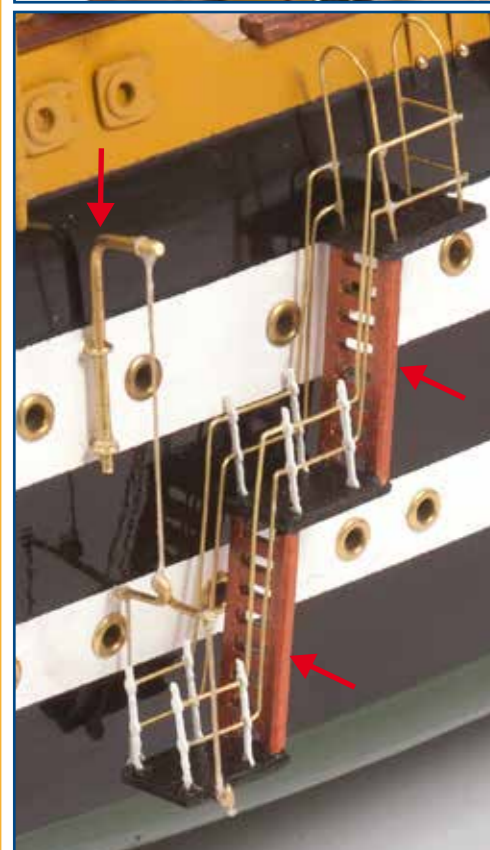
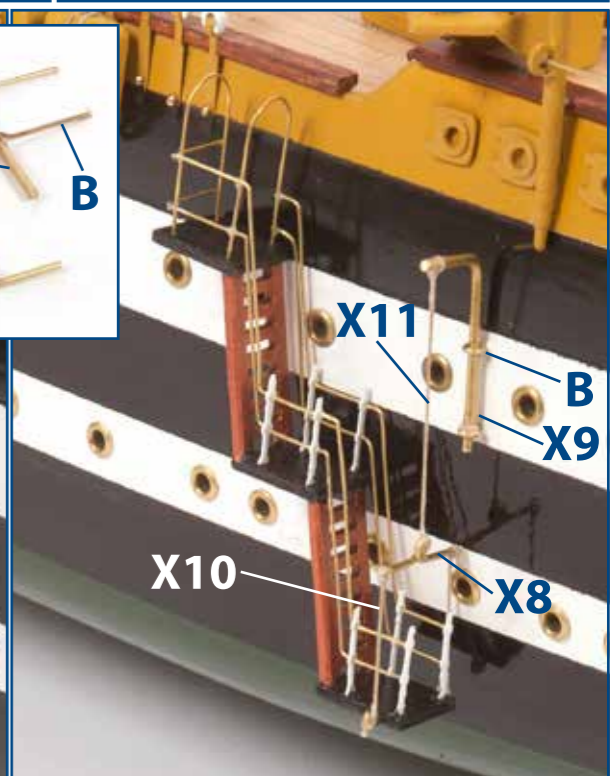
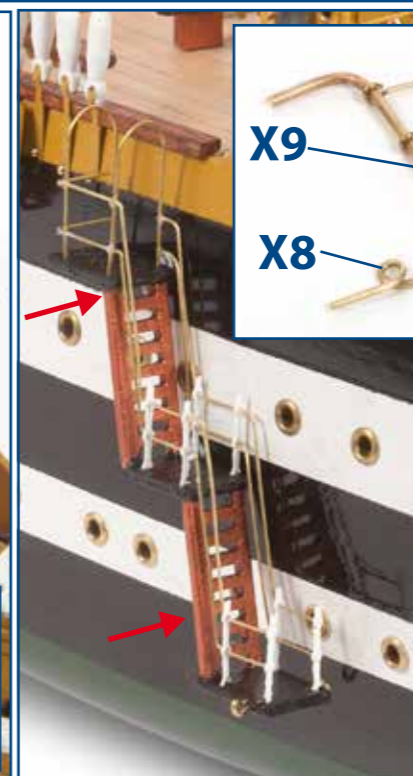
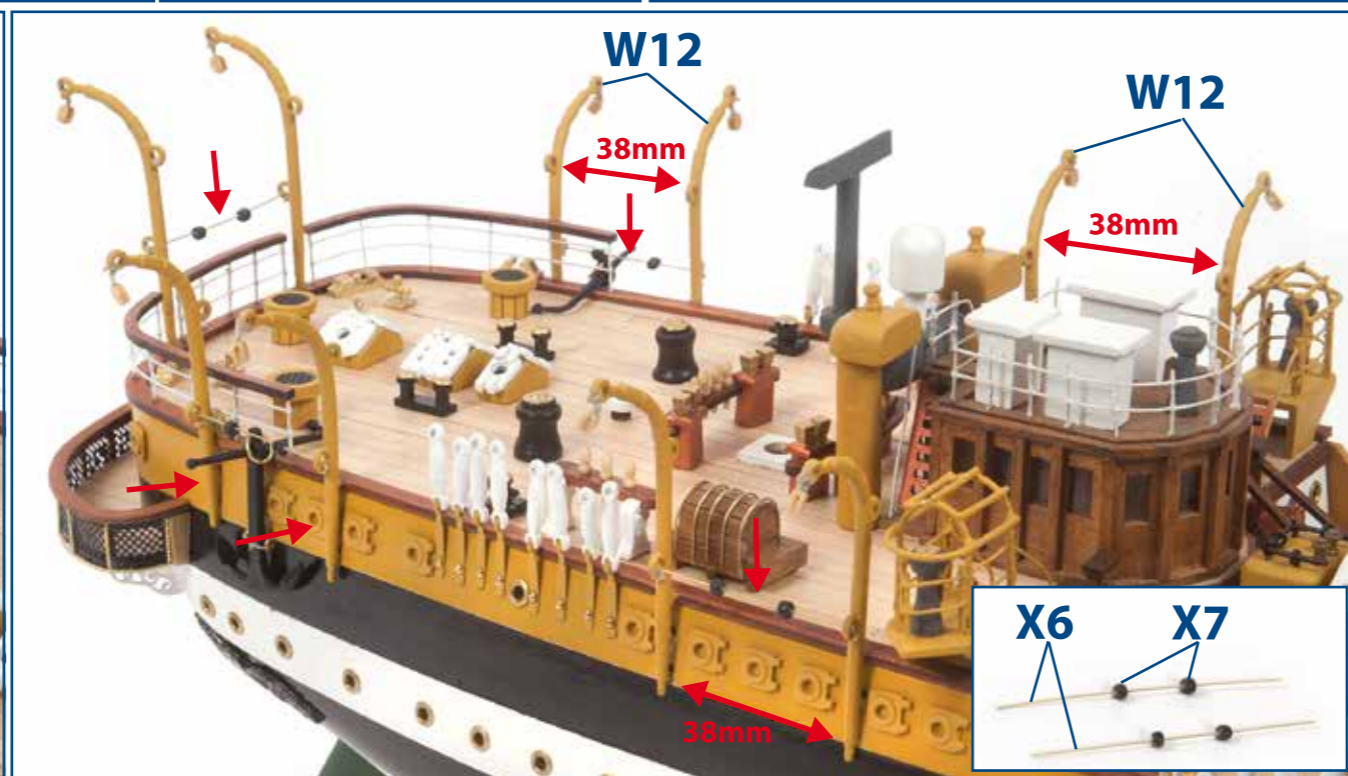
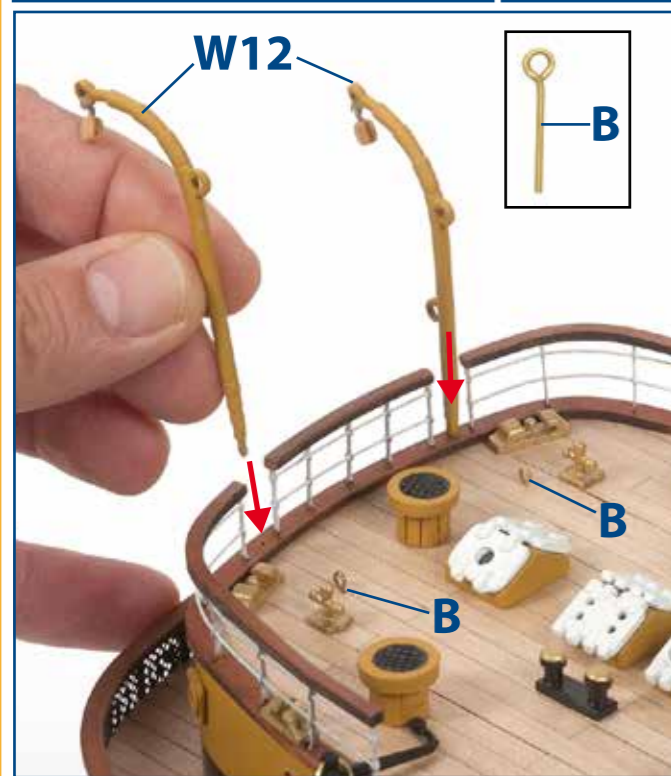
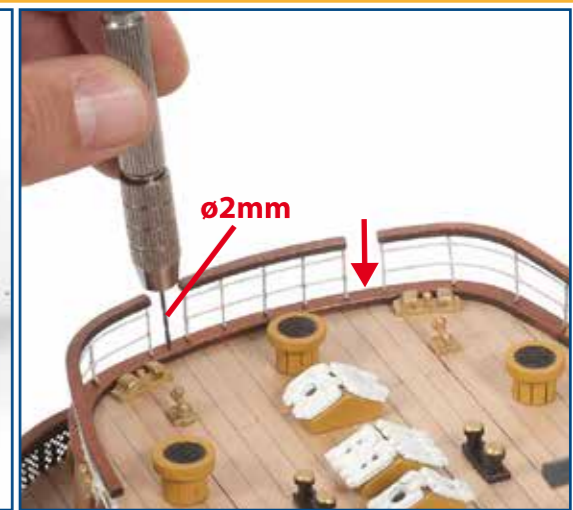
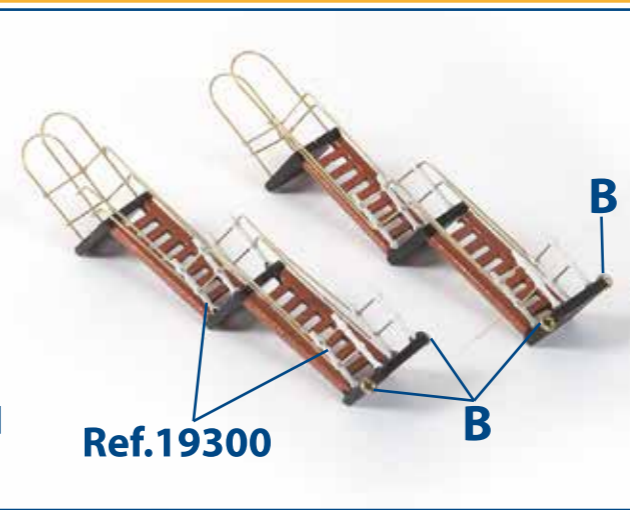
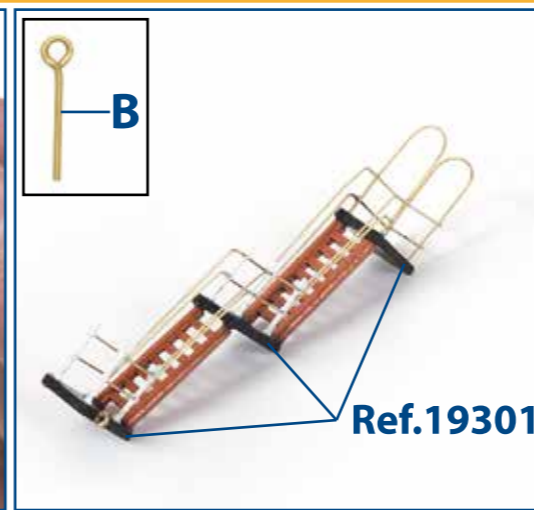
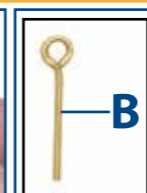
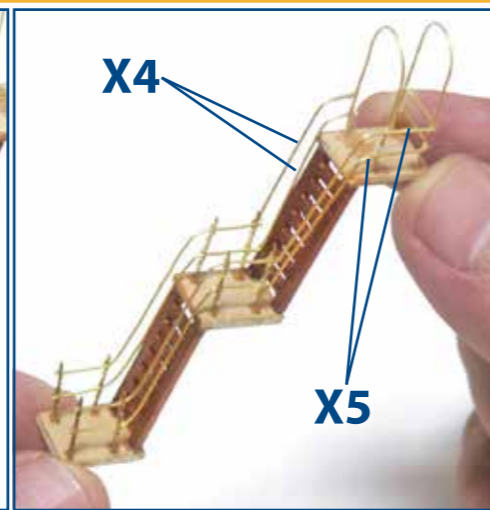
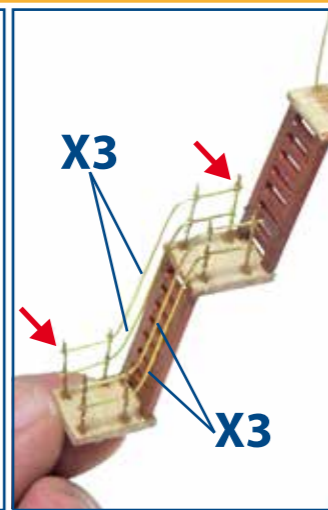
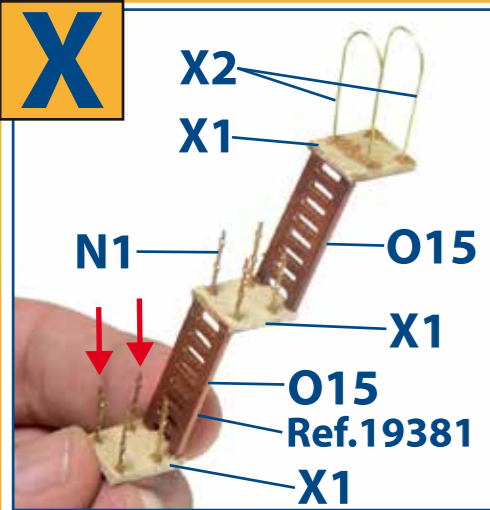

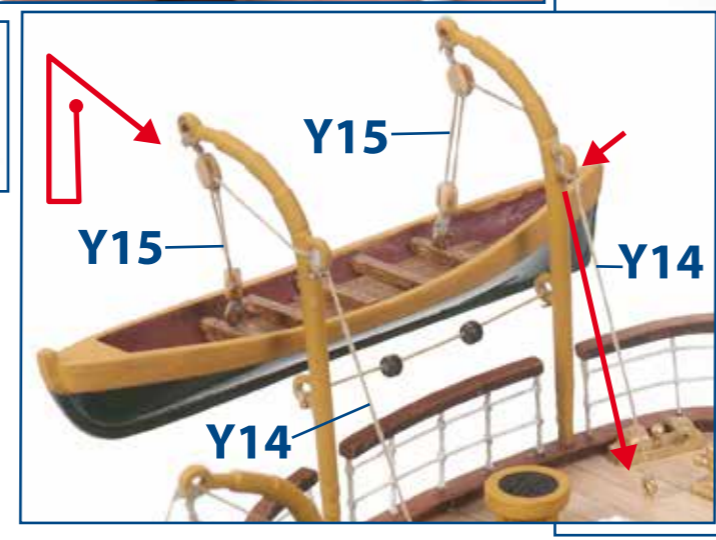
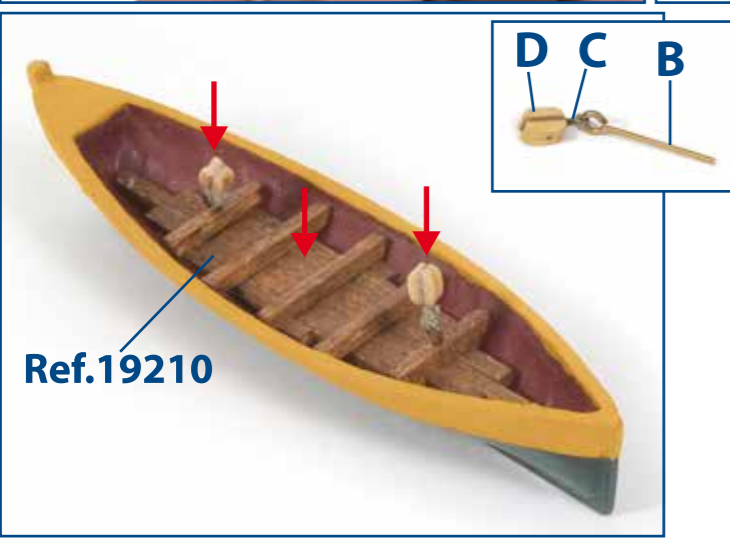
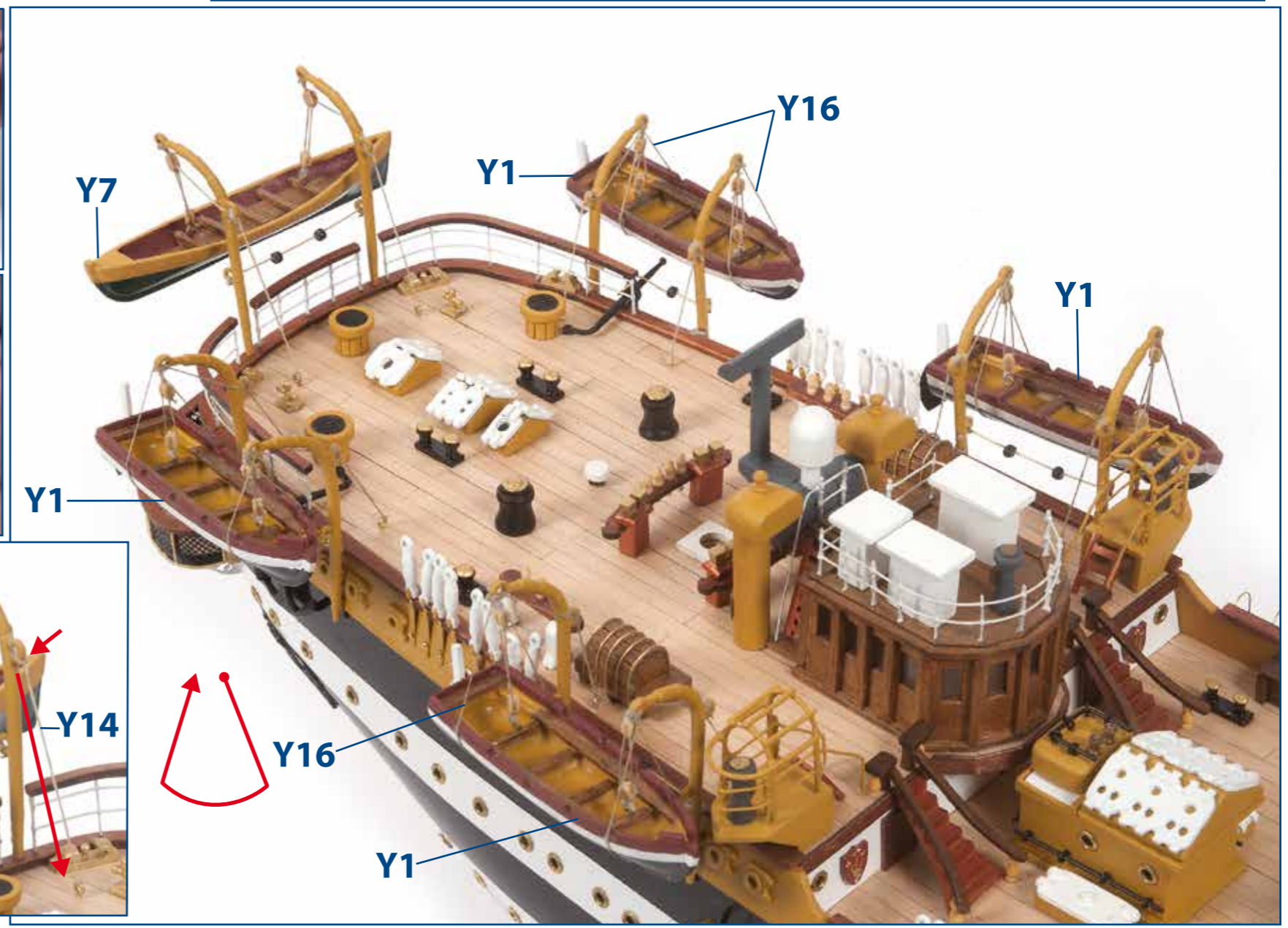
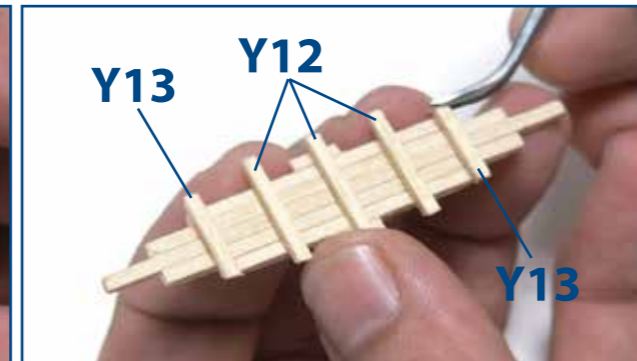
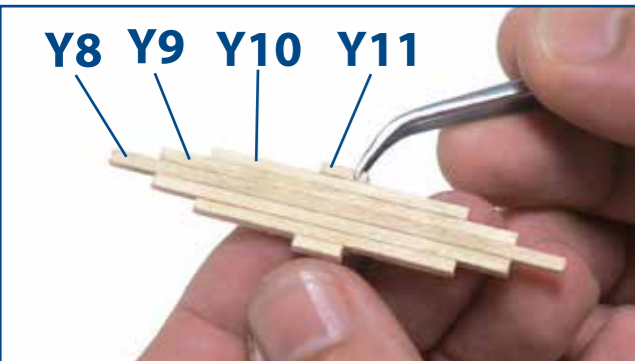
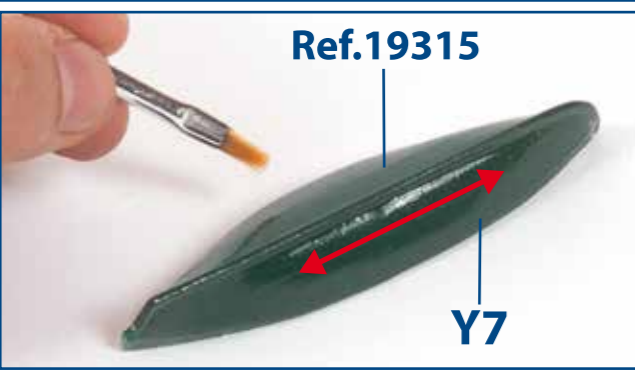
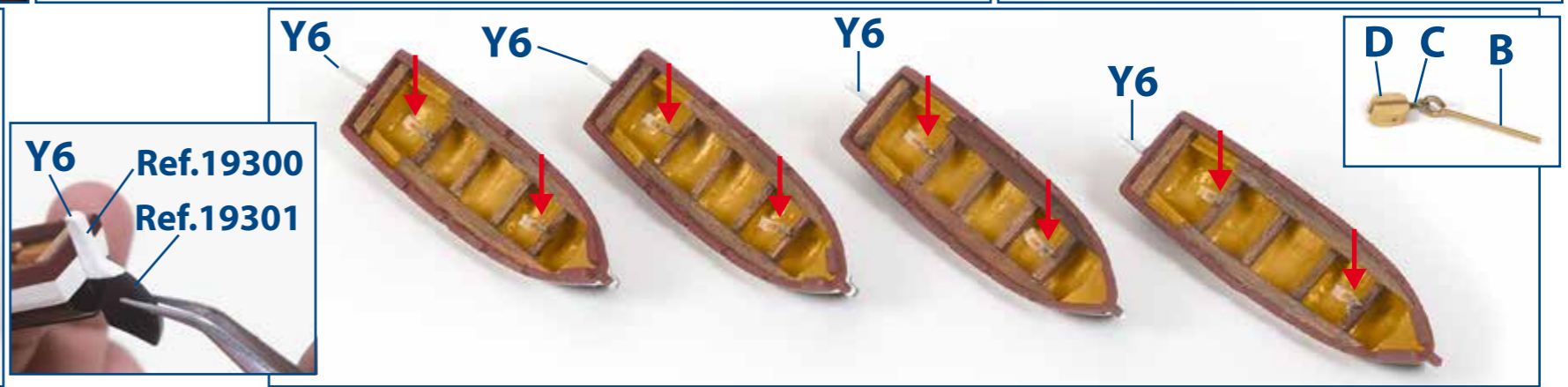
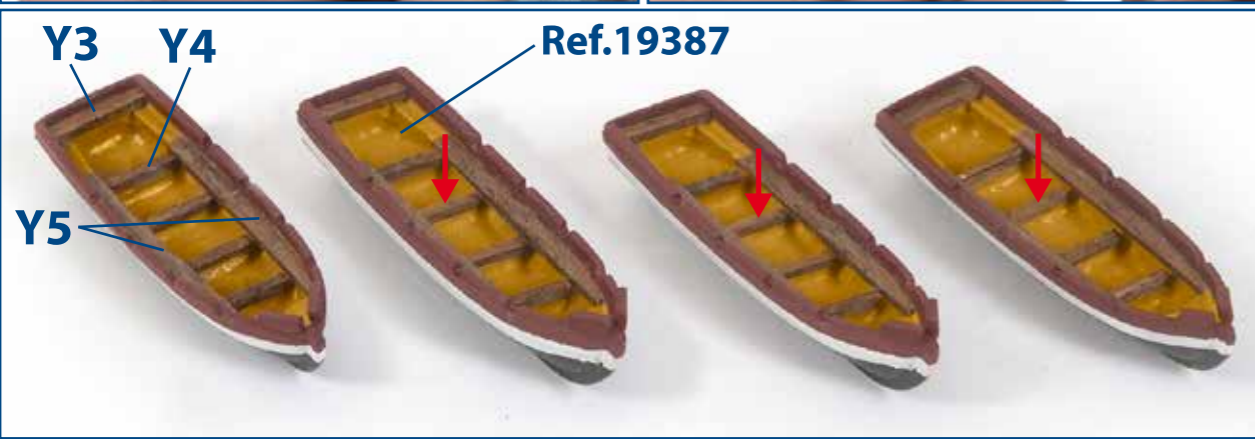
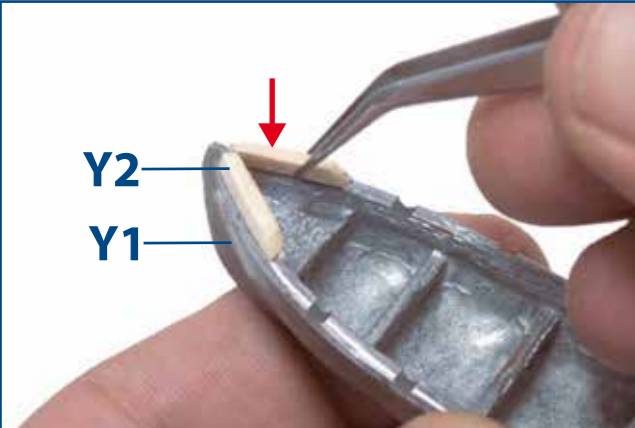

Z

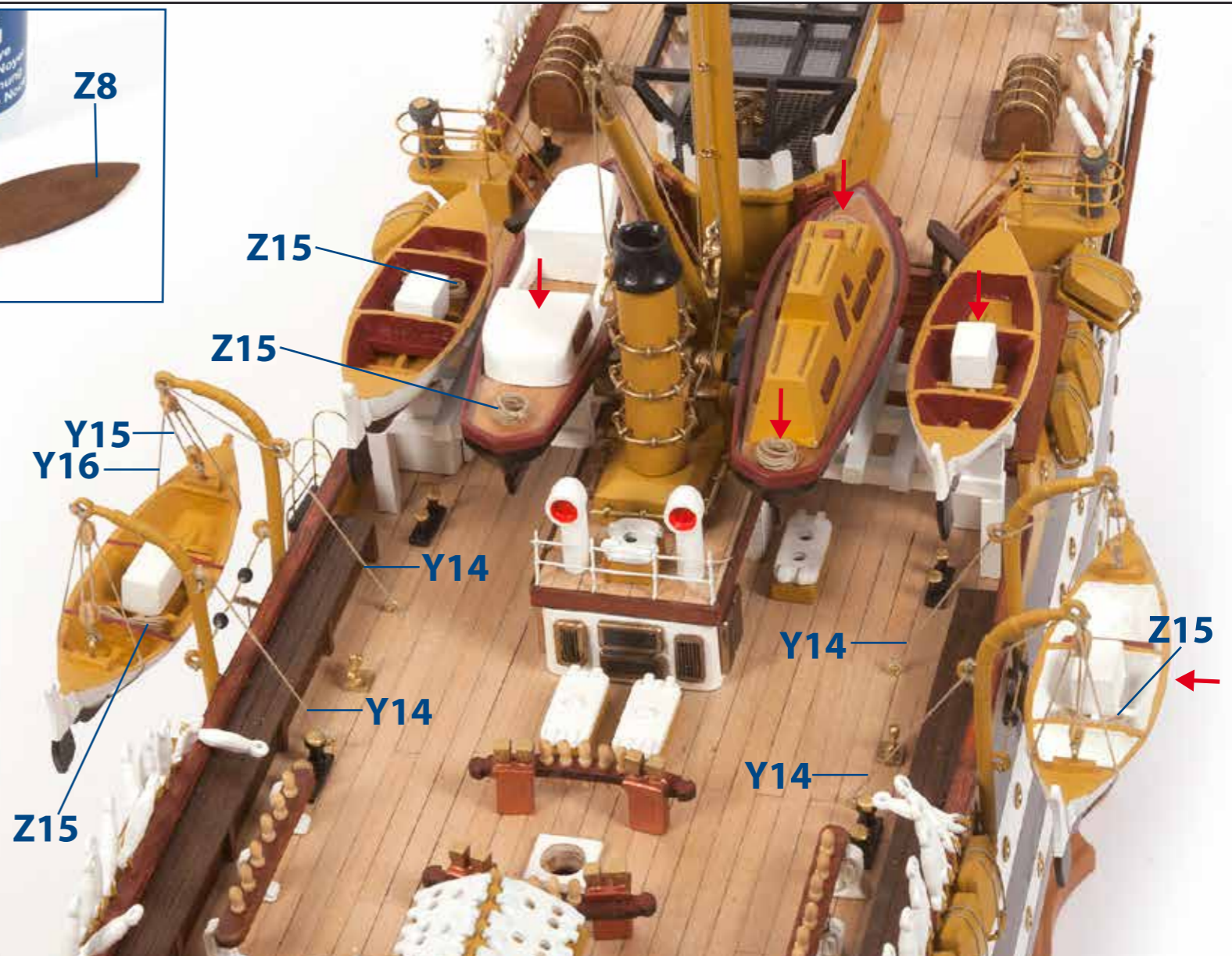
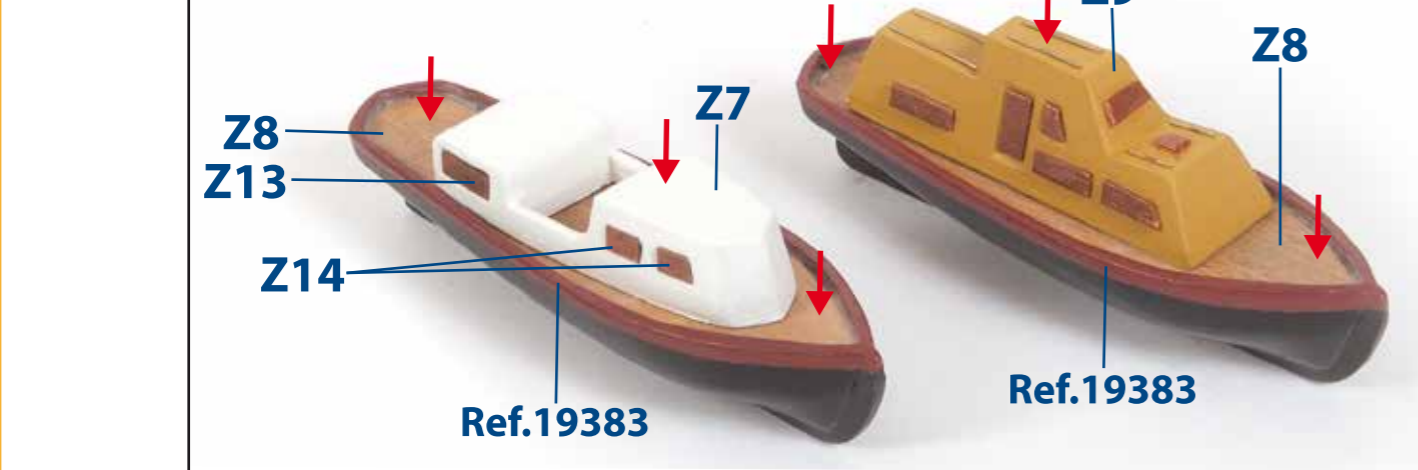
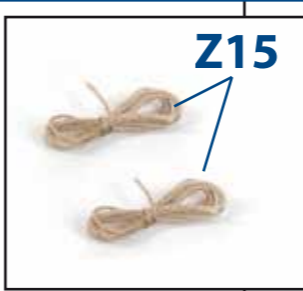
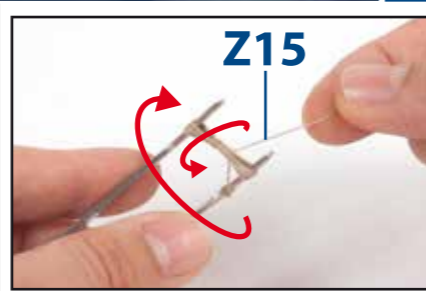
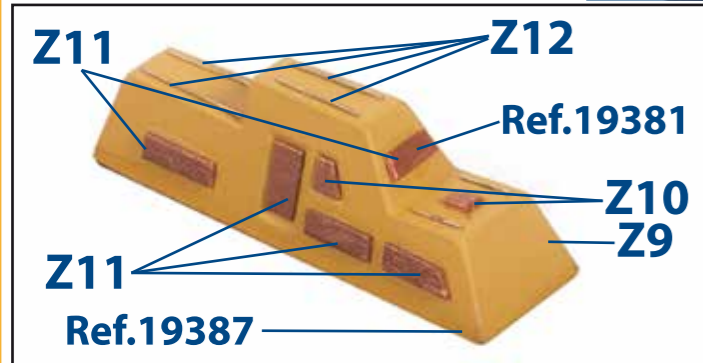
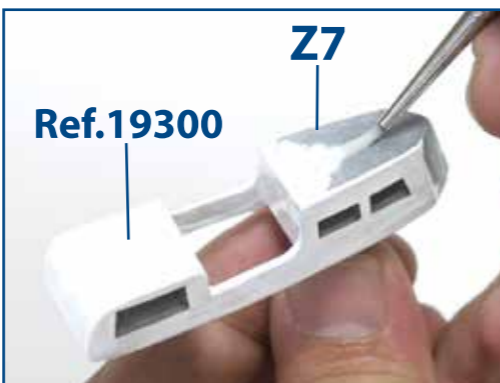
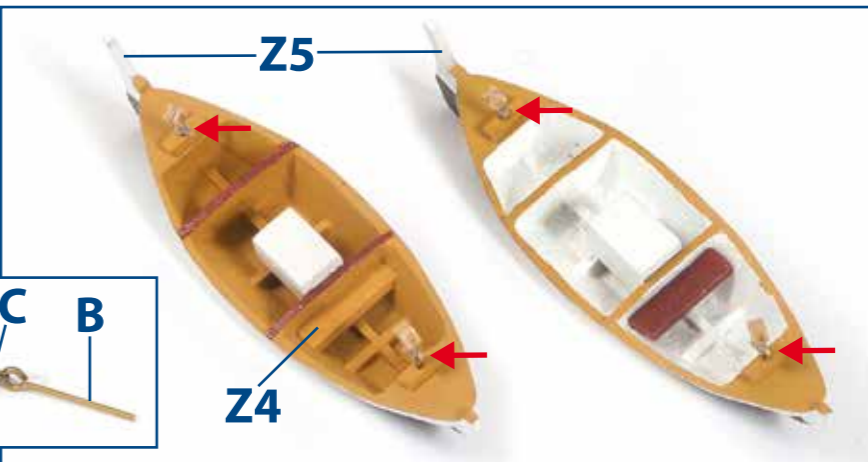
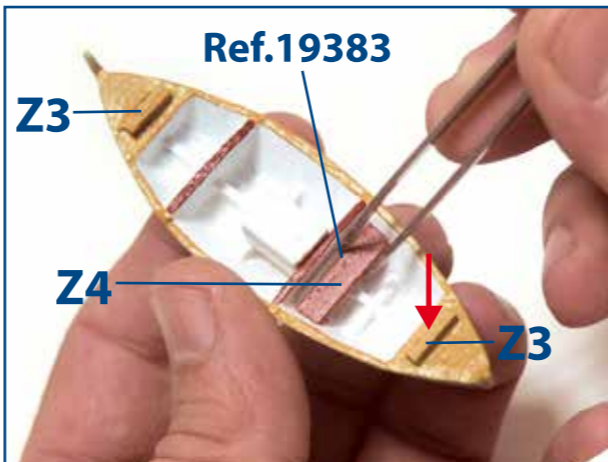
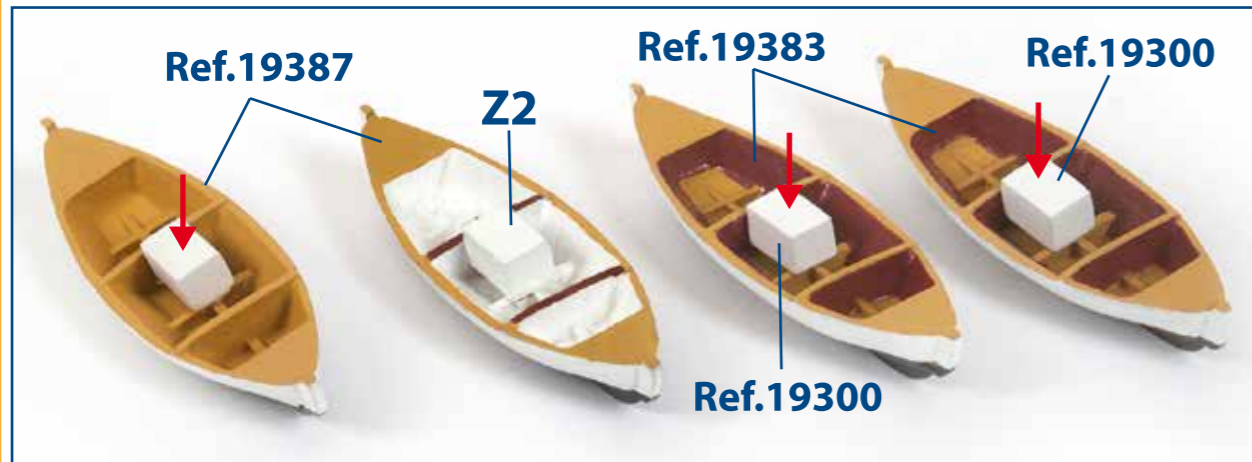
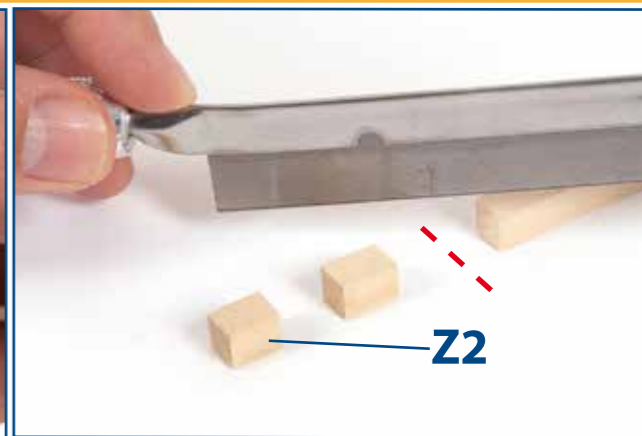
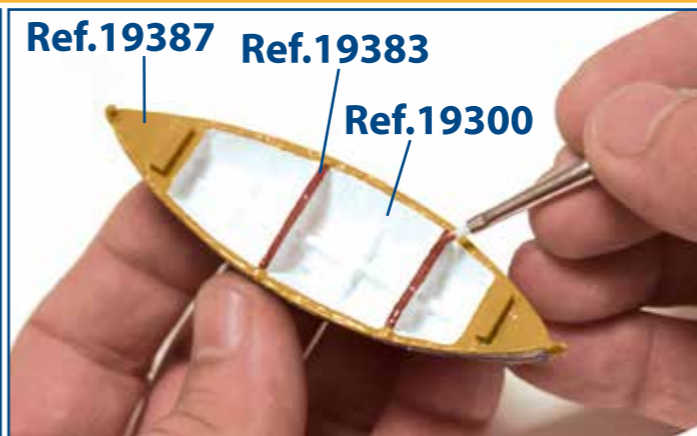

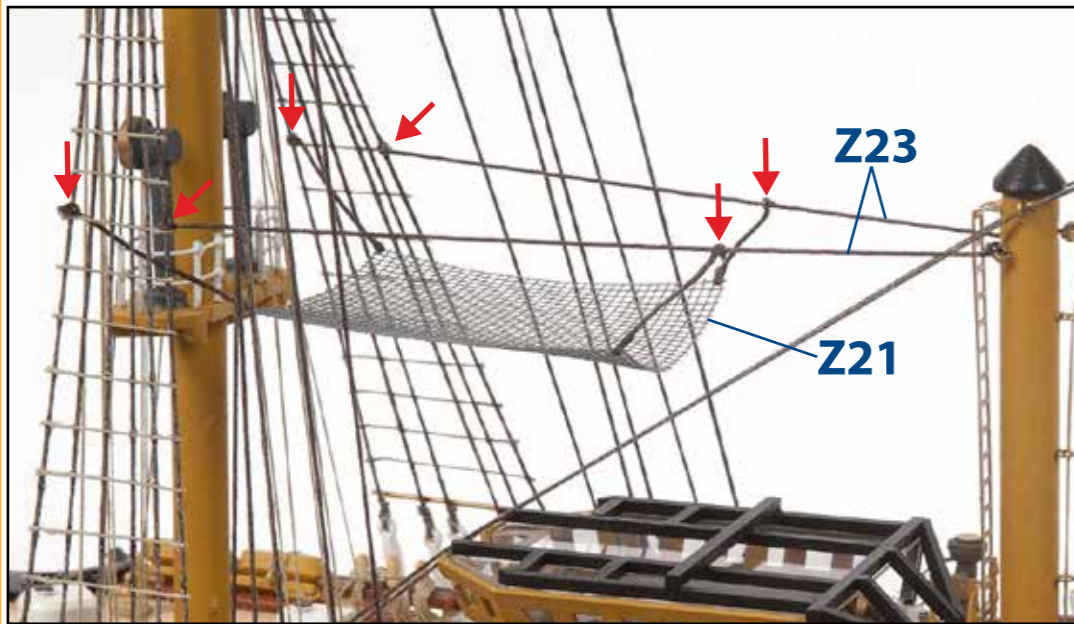
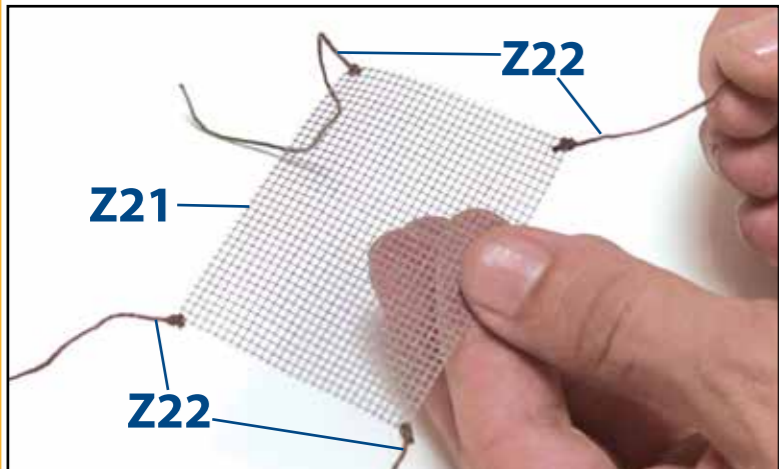
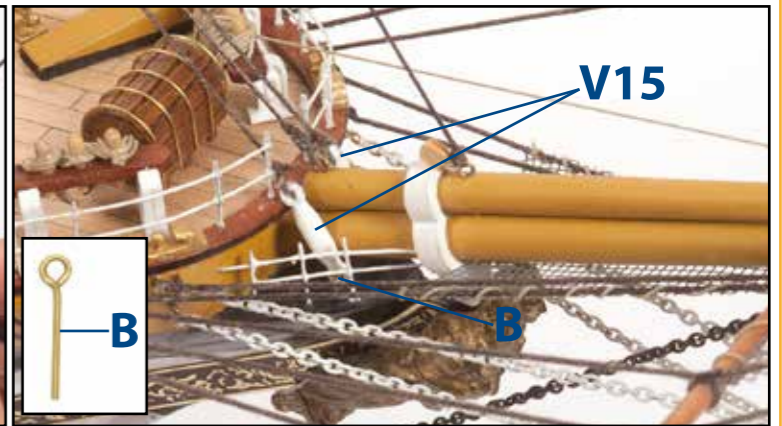
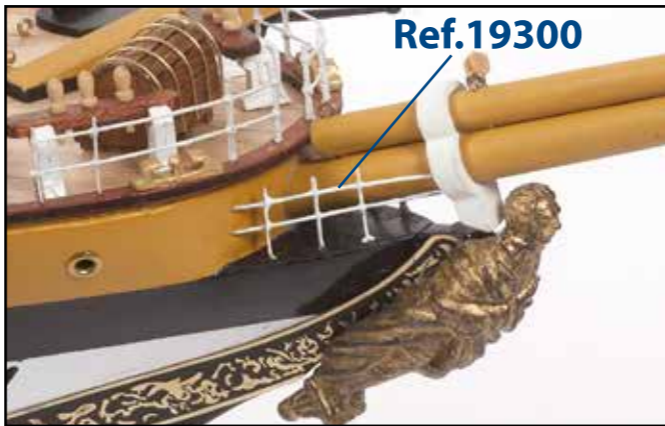
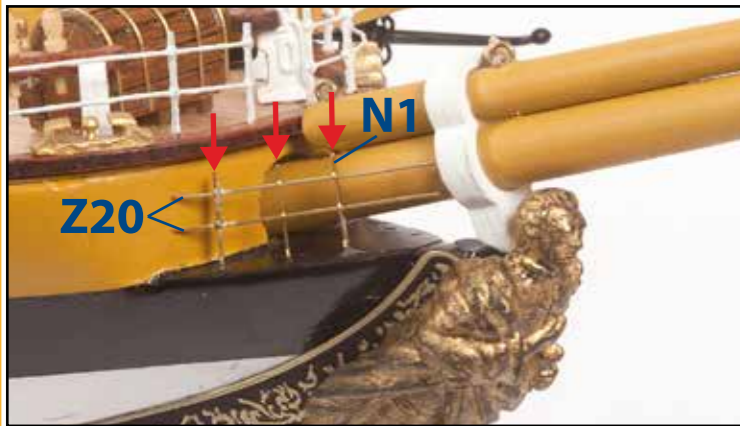
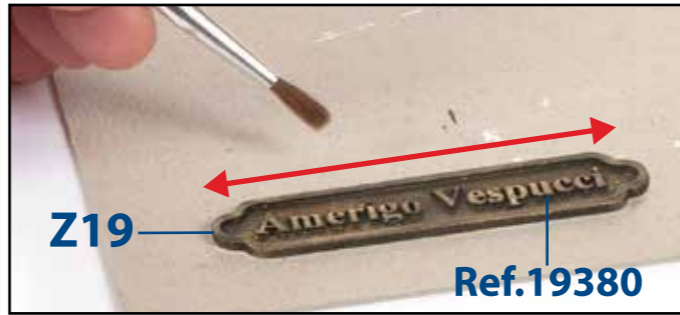
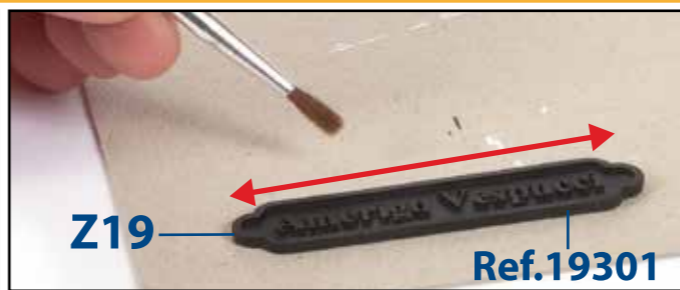
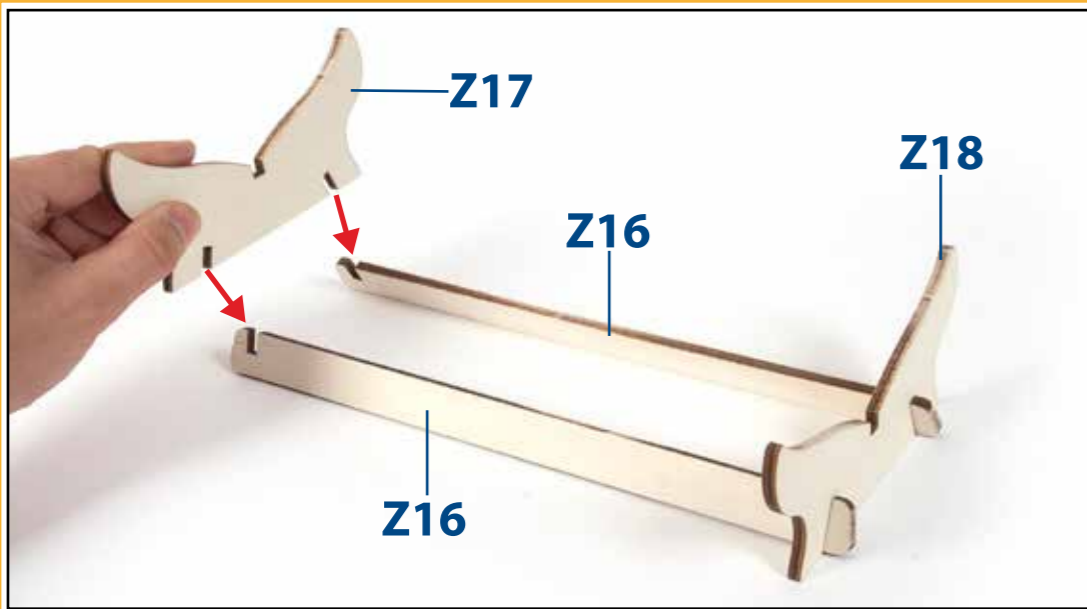



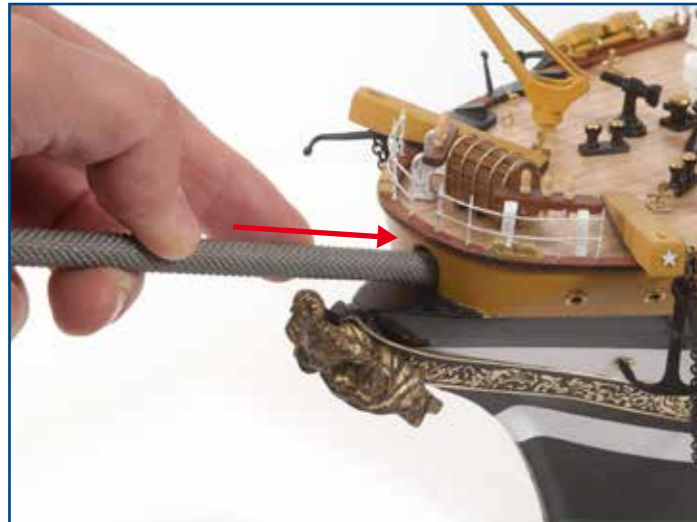
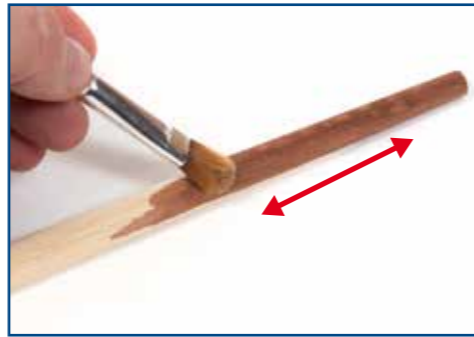
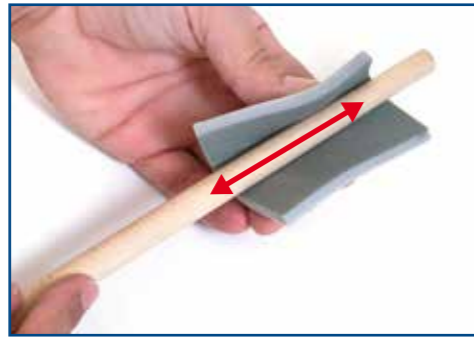
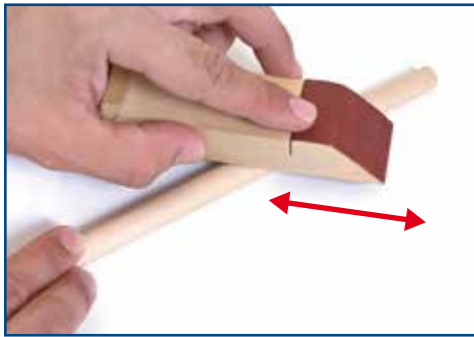

Consultar los planos de mástiles
Consult the masts drawings
Consulte os desenhos dos mastros
Consulter les dessins des mâts
Konsultieren Sie die Mastenzeichnungen
Обратитесь к рисункам мачты
Consultare i disegni degli alberi

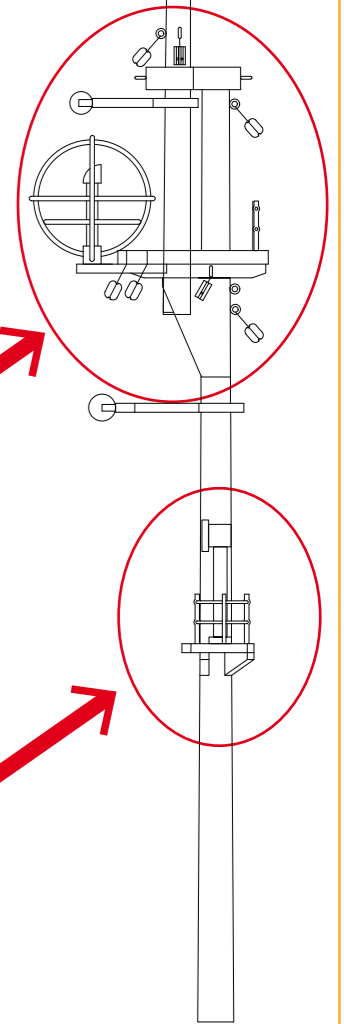
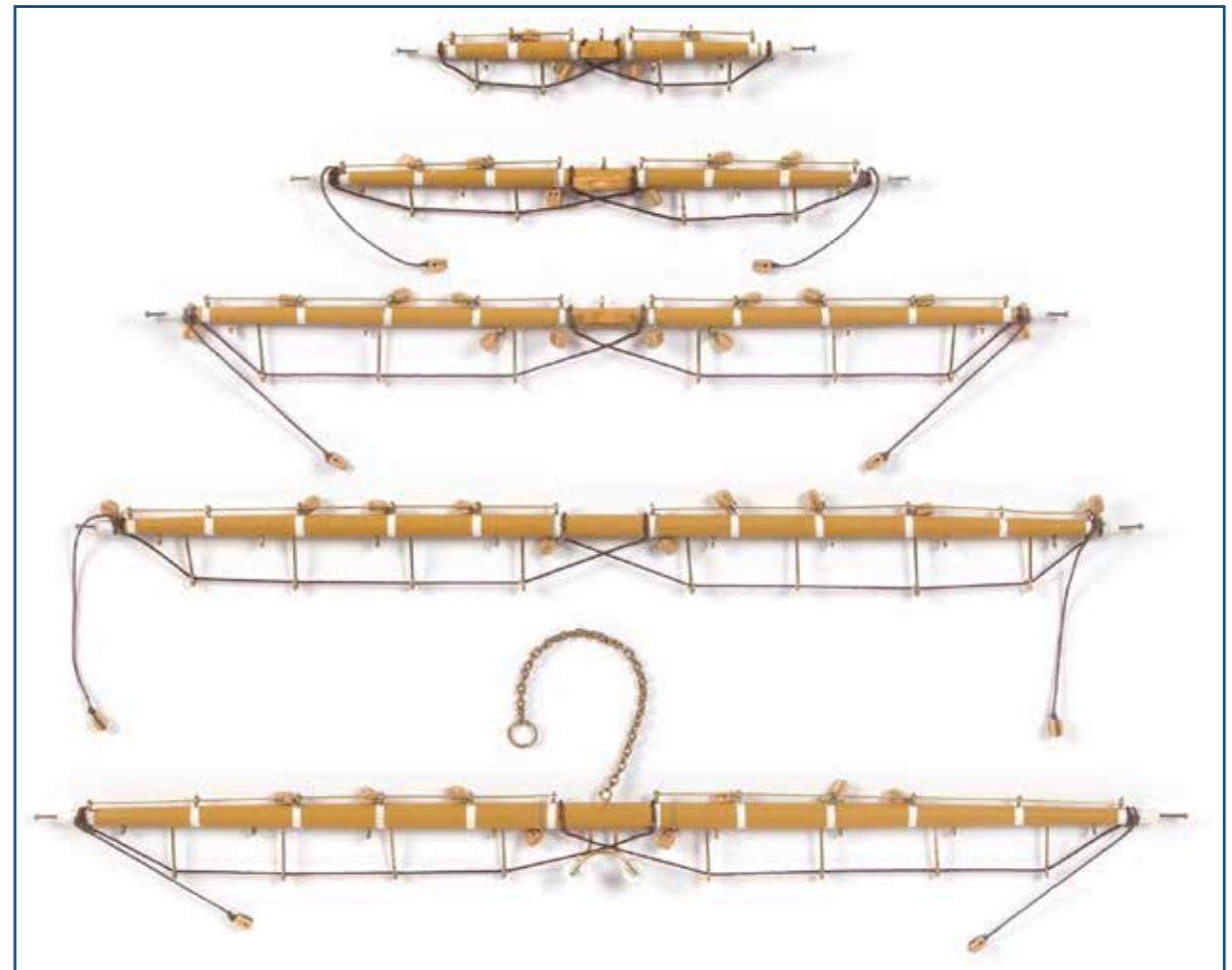
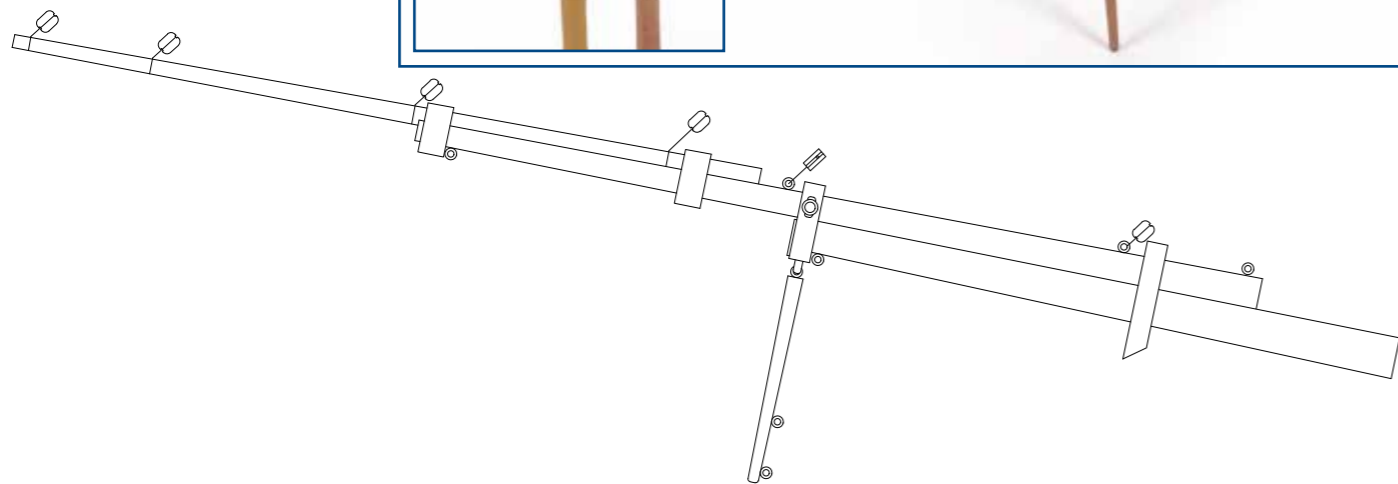
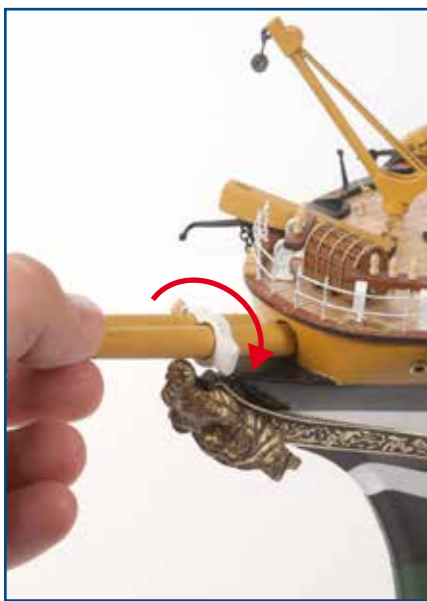

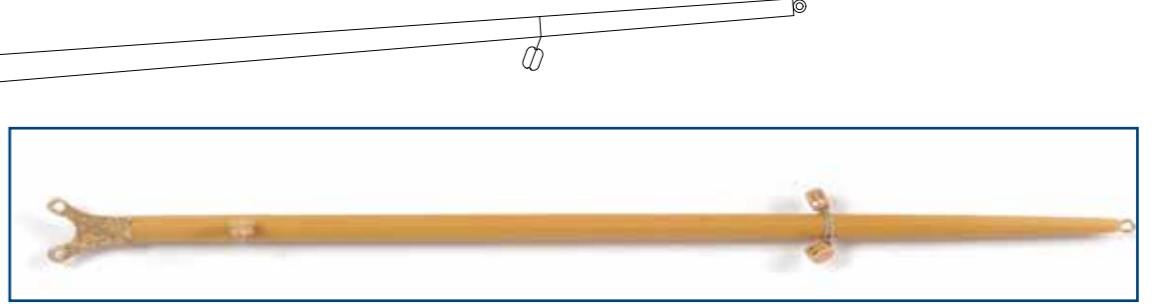
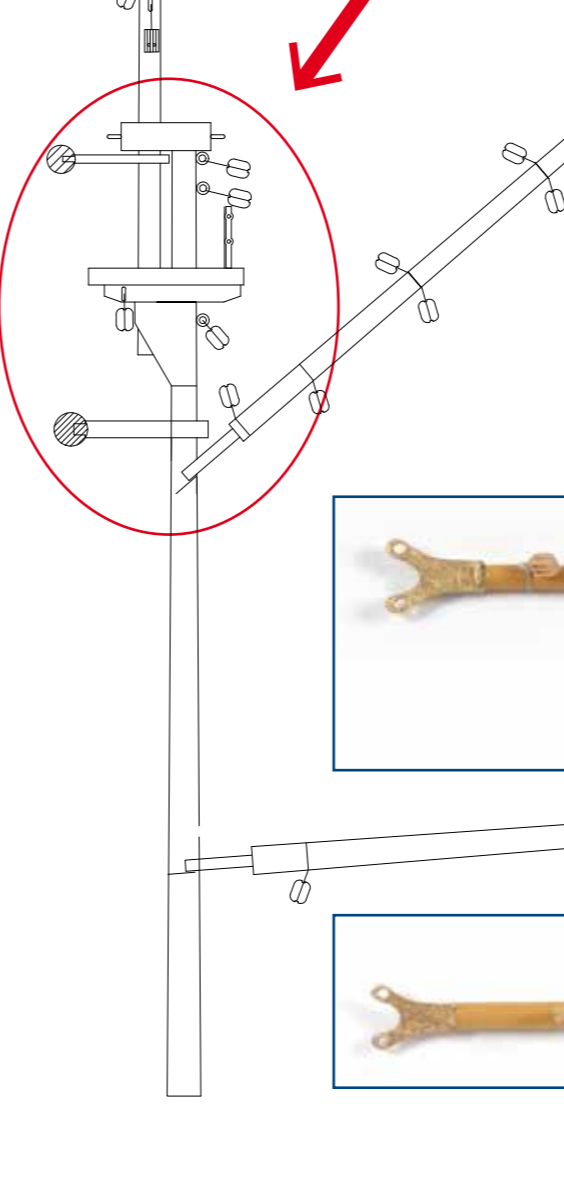
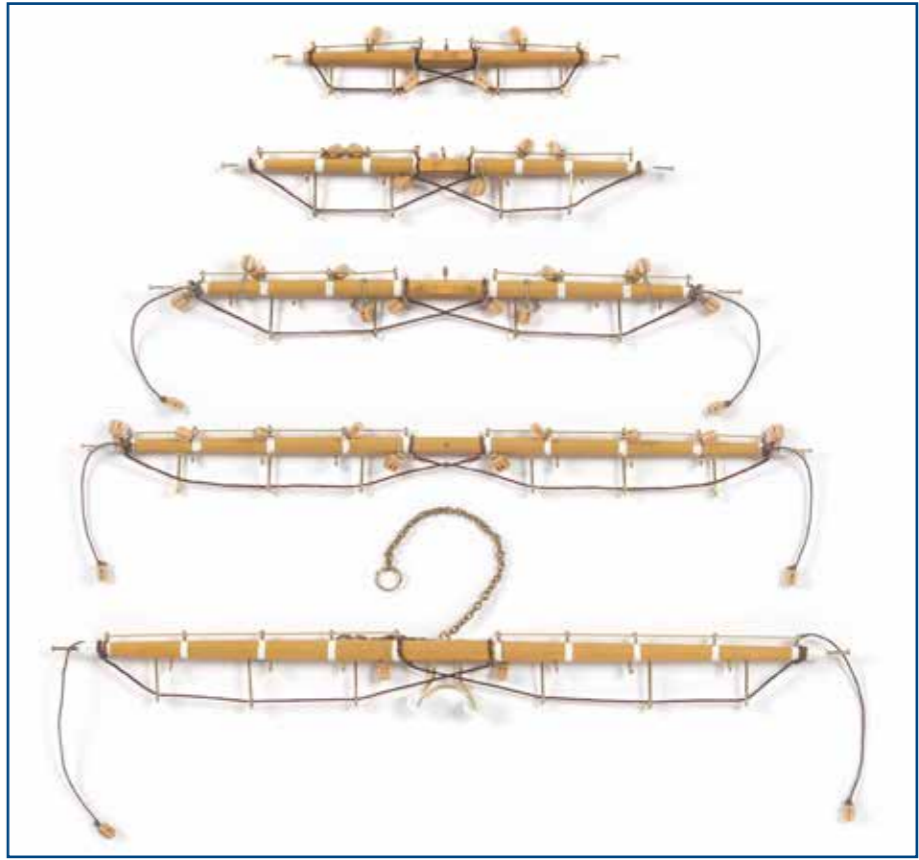
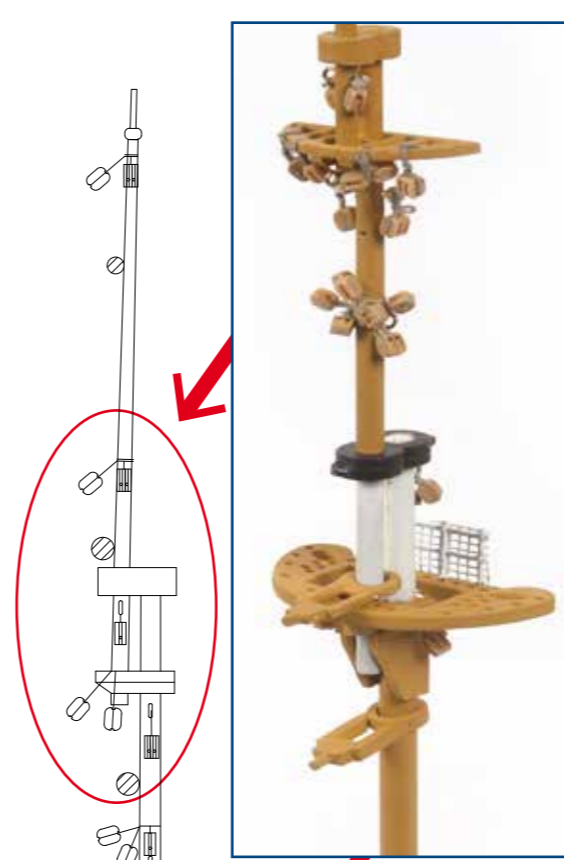
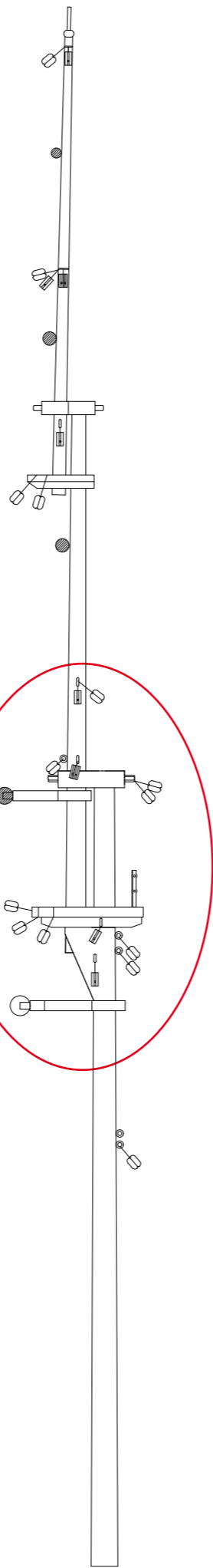
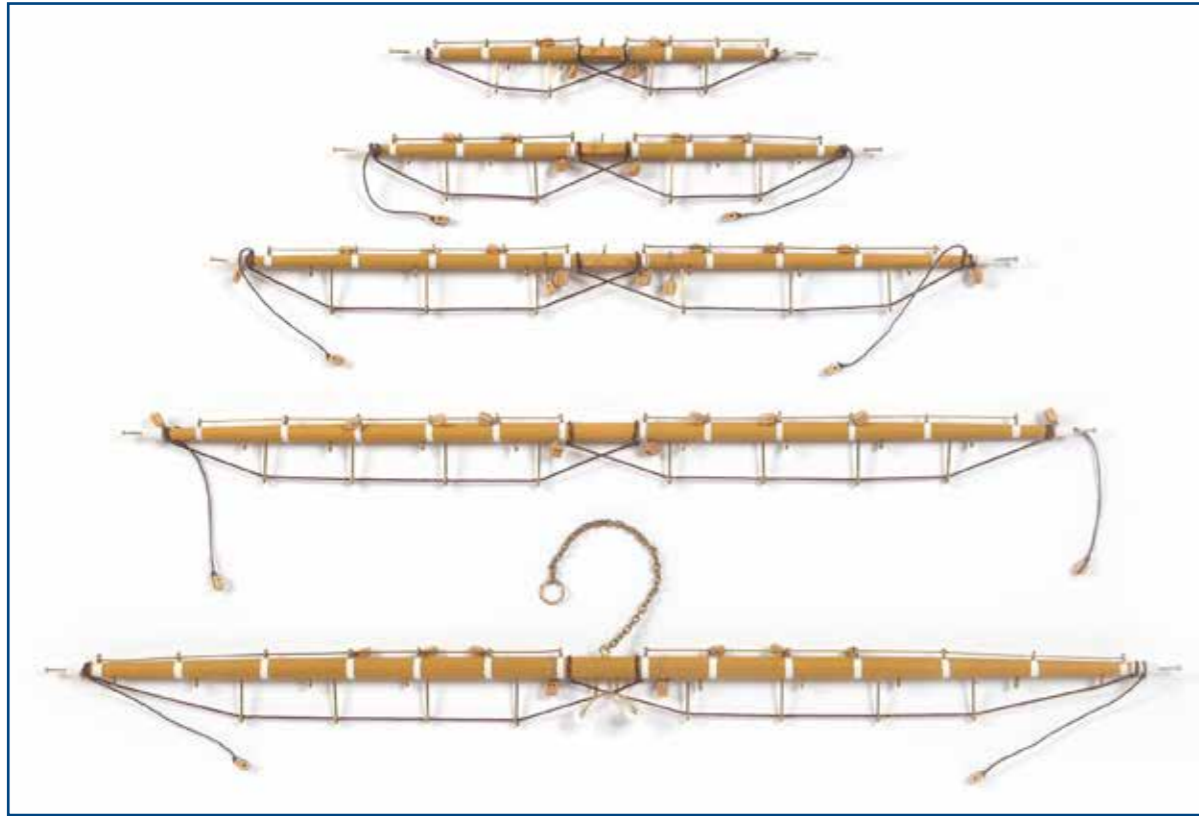

IP

Amerigo Vespucci

Ref.15006

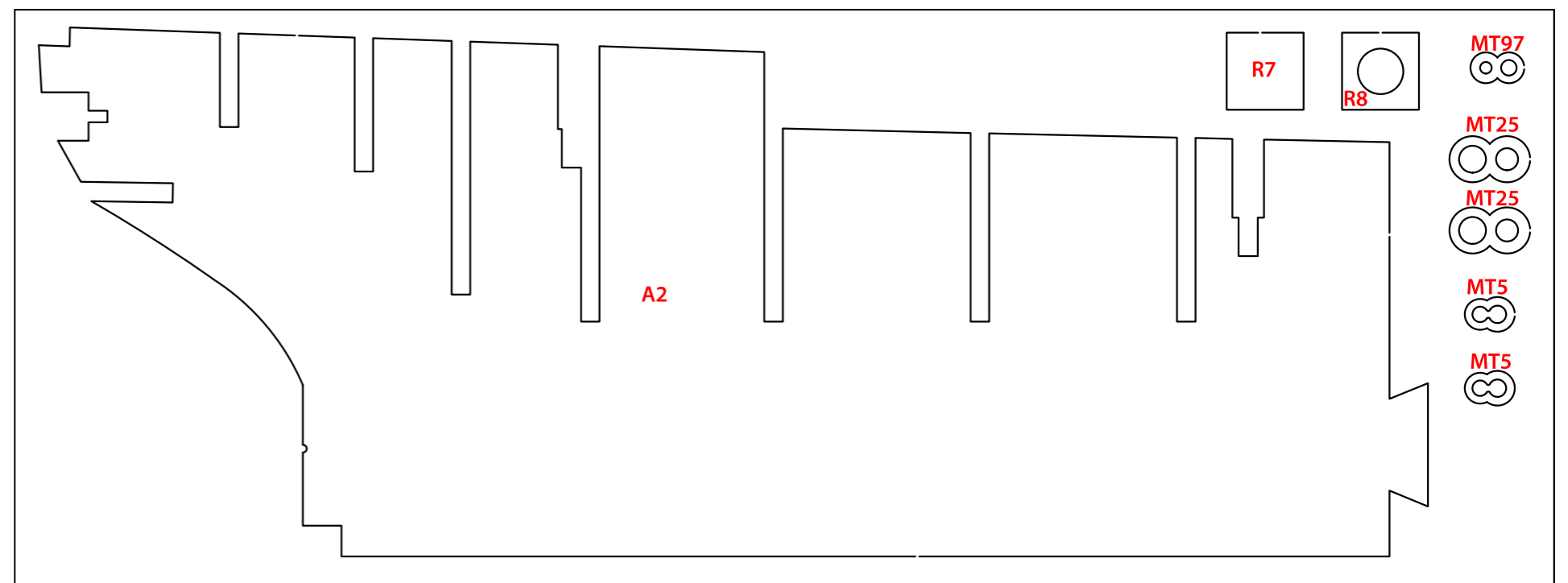
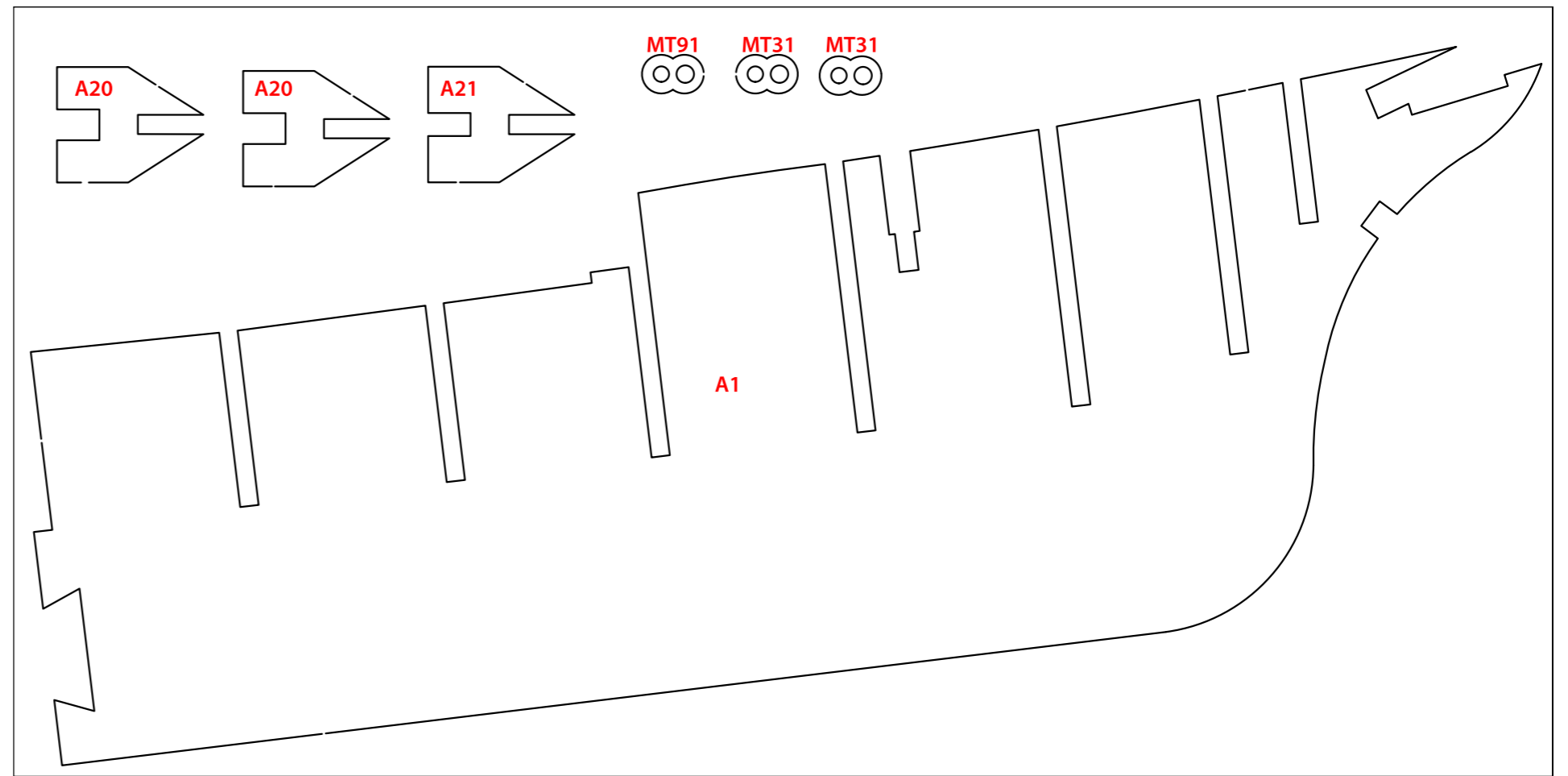
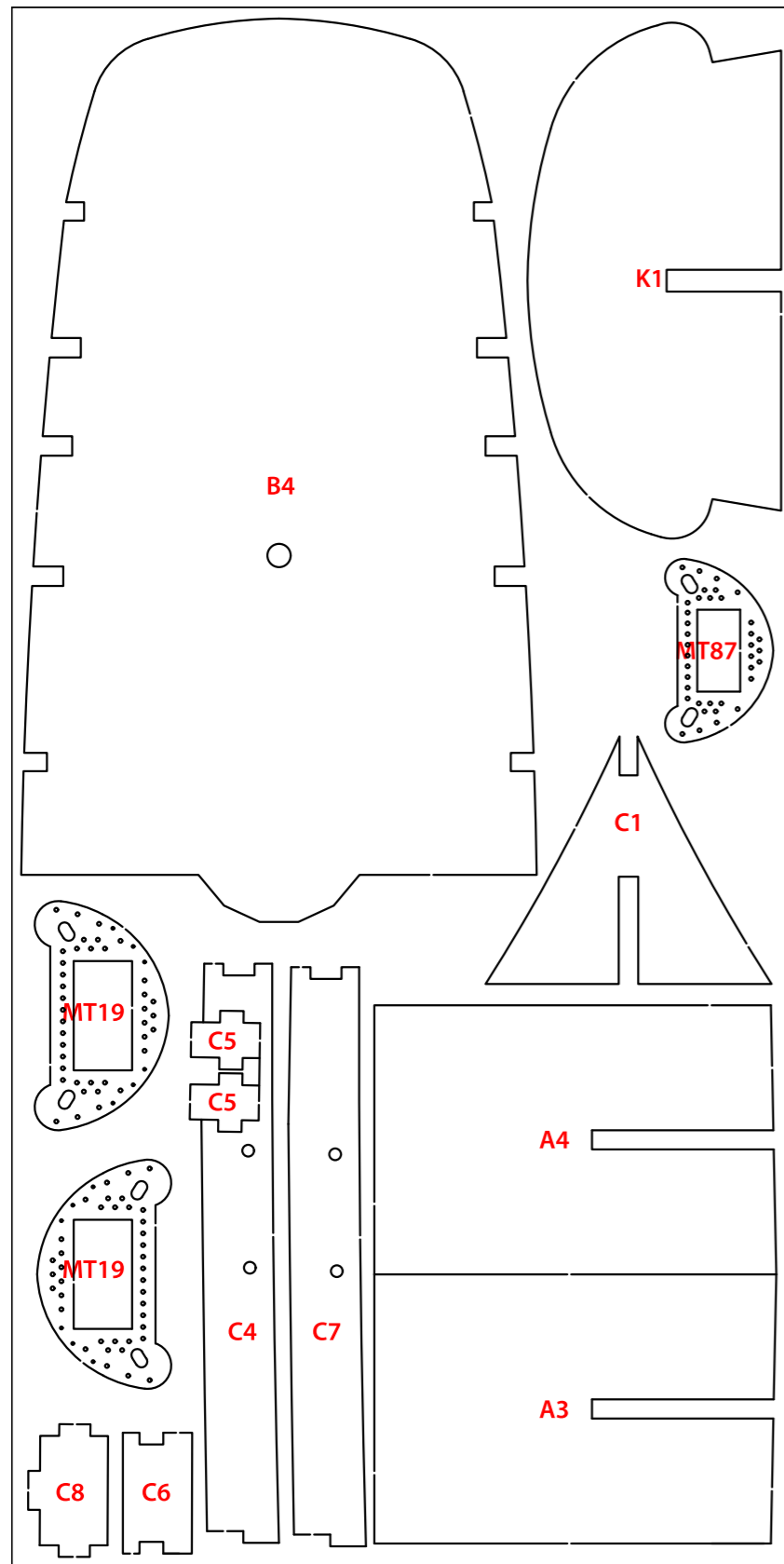

IP

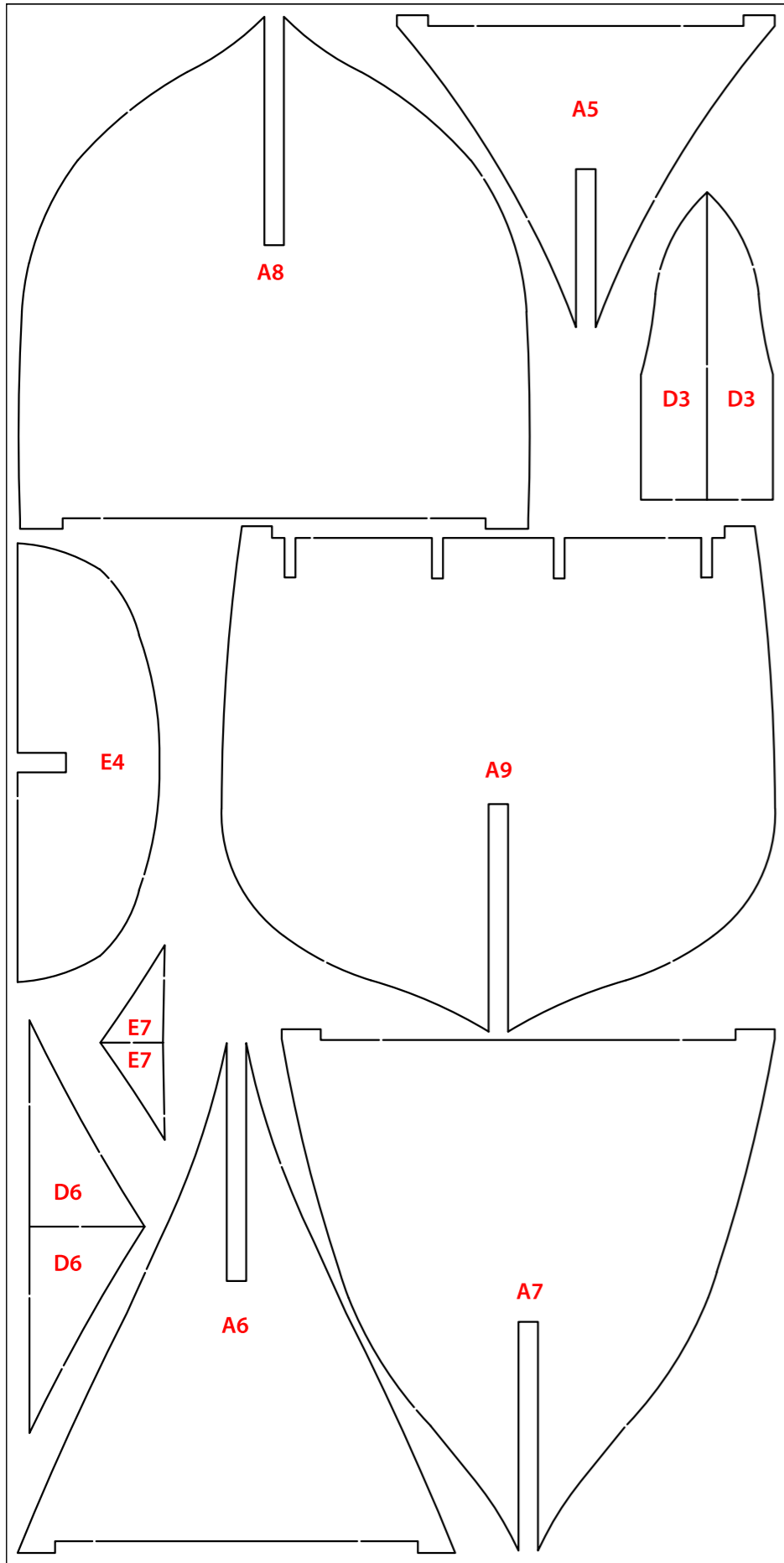

15006-4

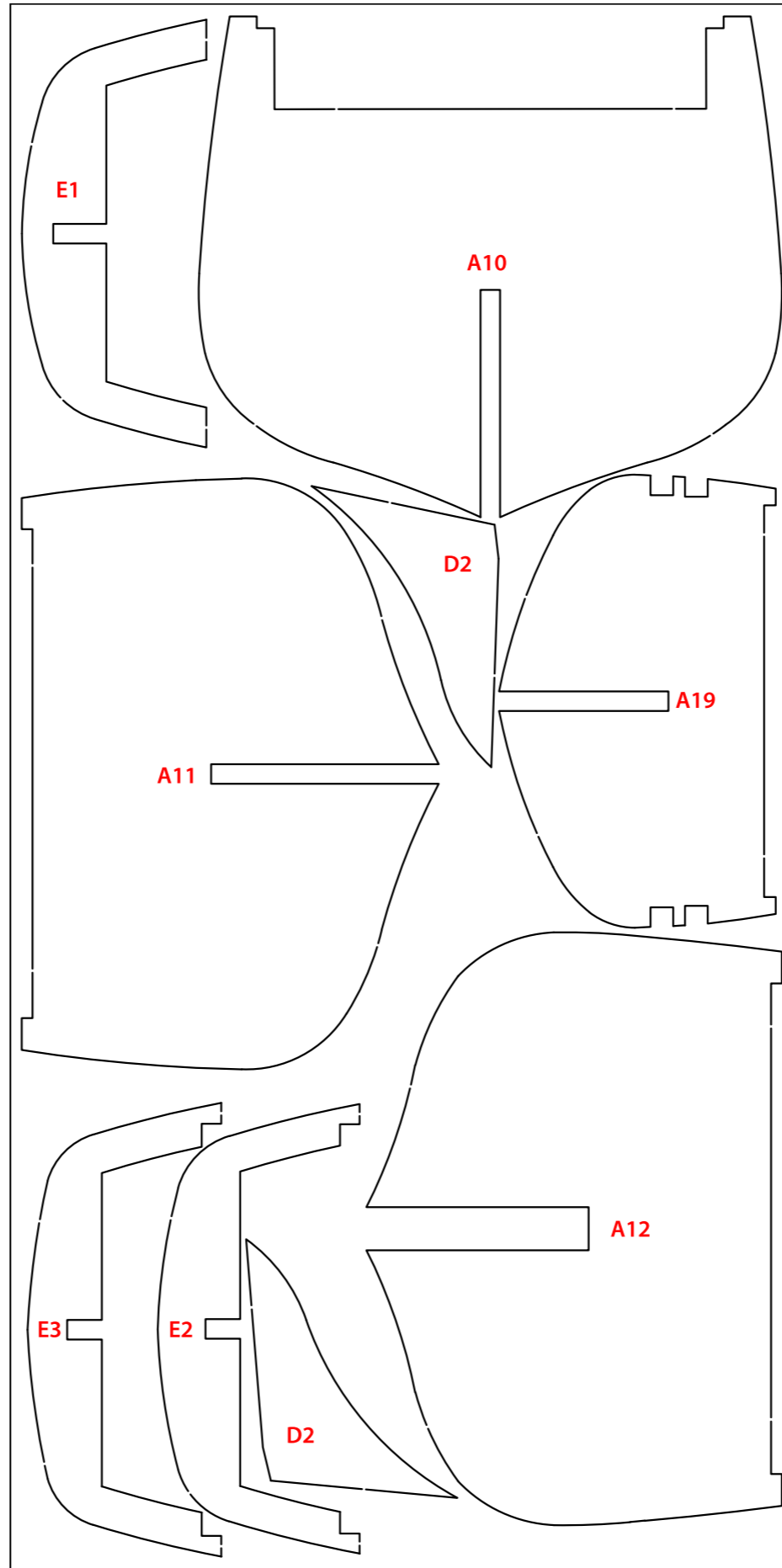

15006-3

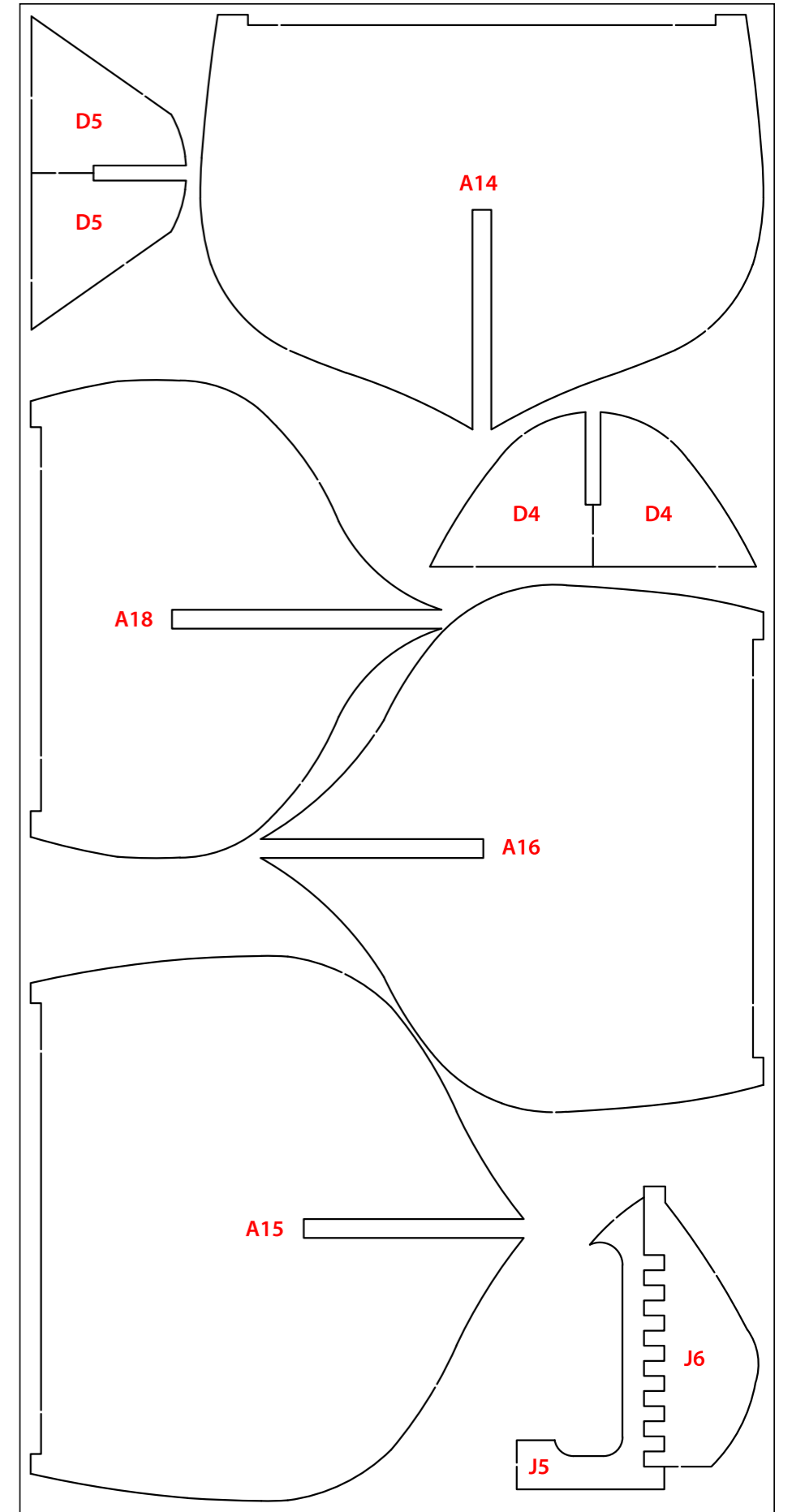

15006-5

IP

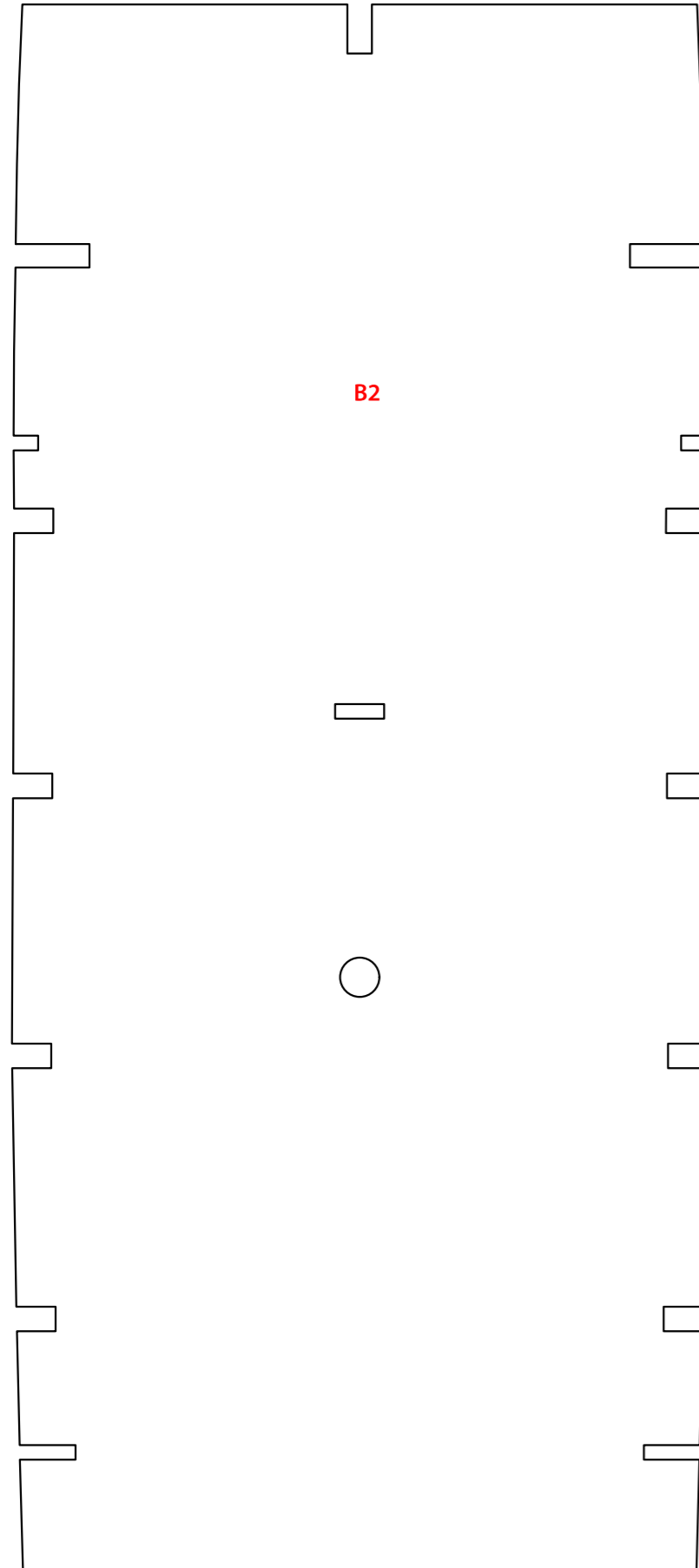

15006-8

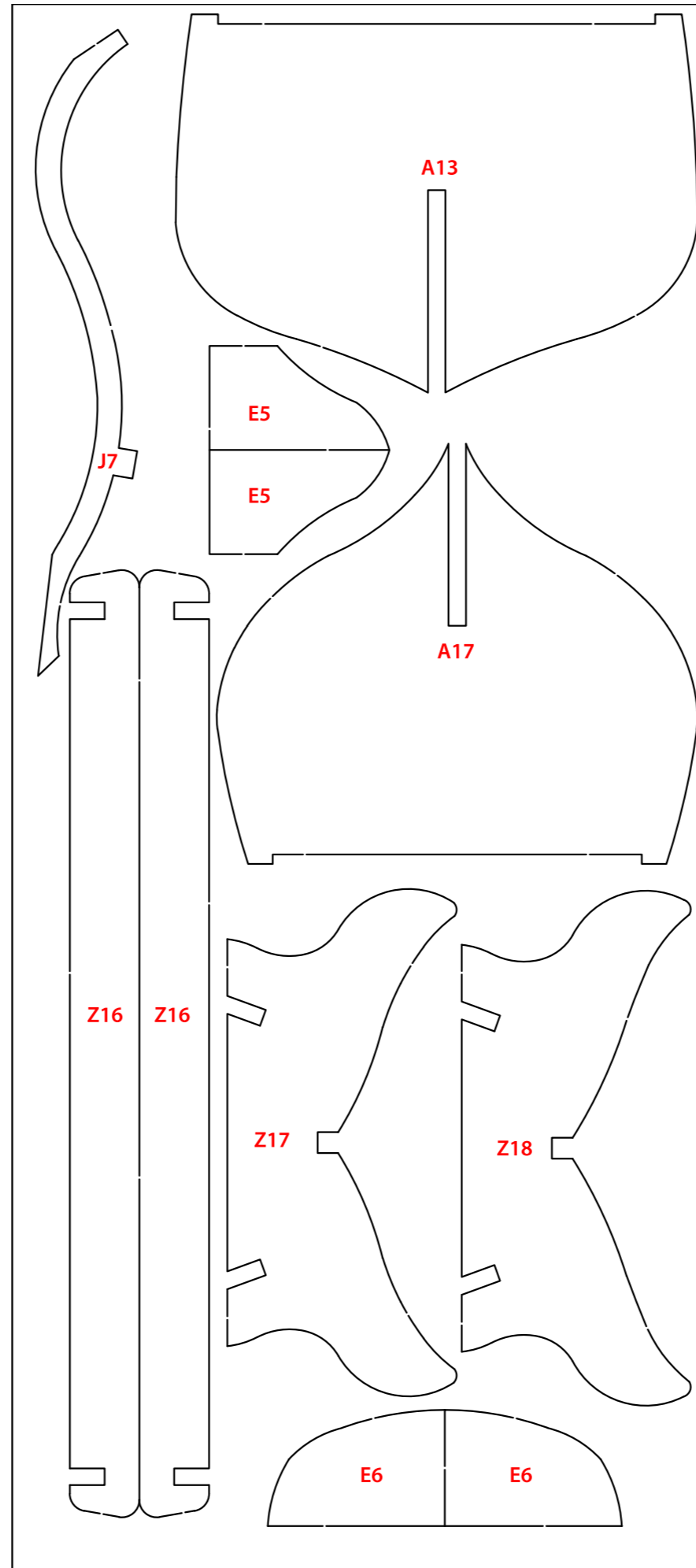

15006-6

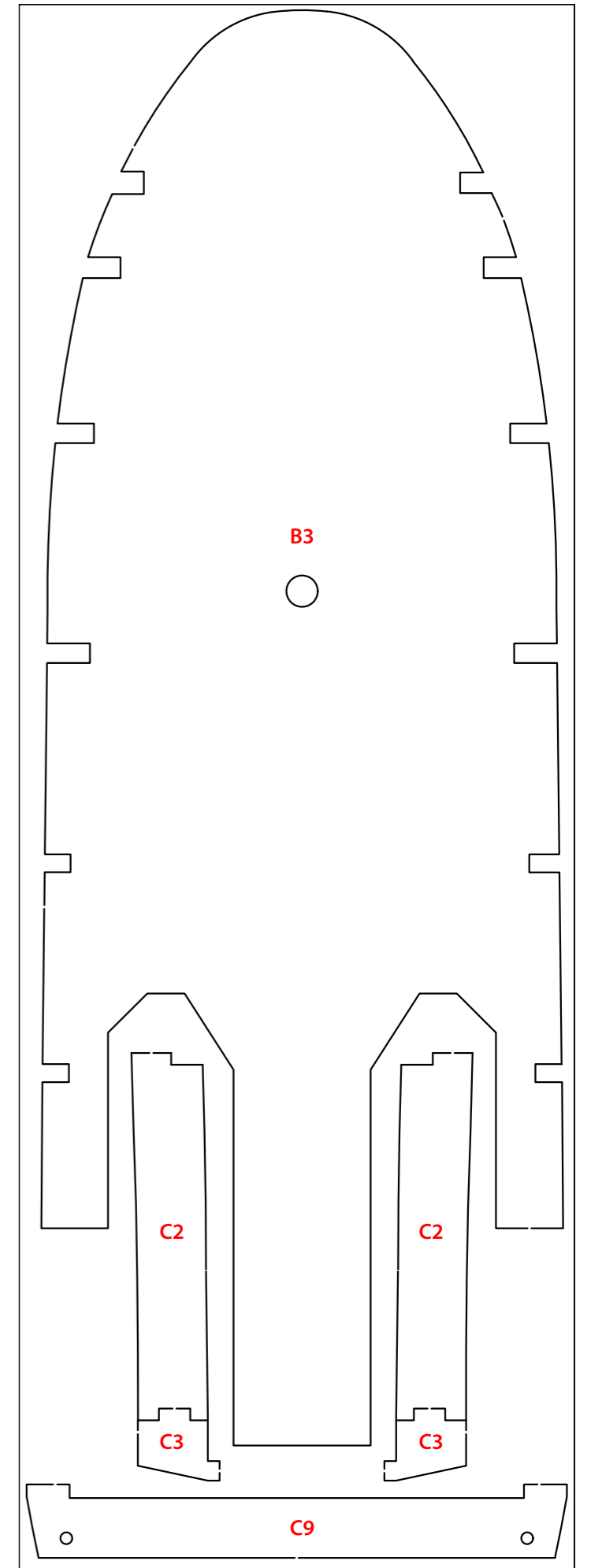

15006-7

IP

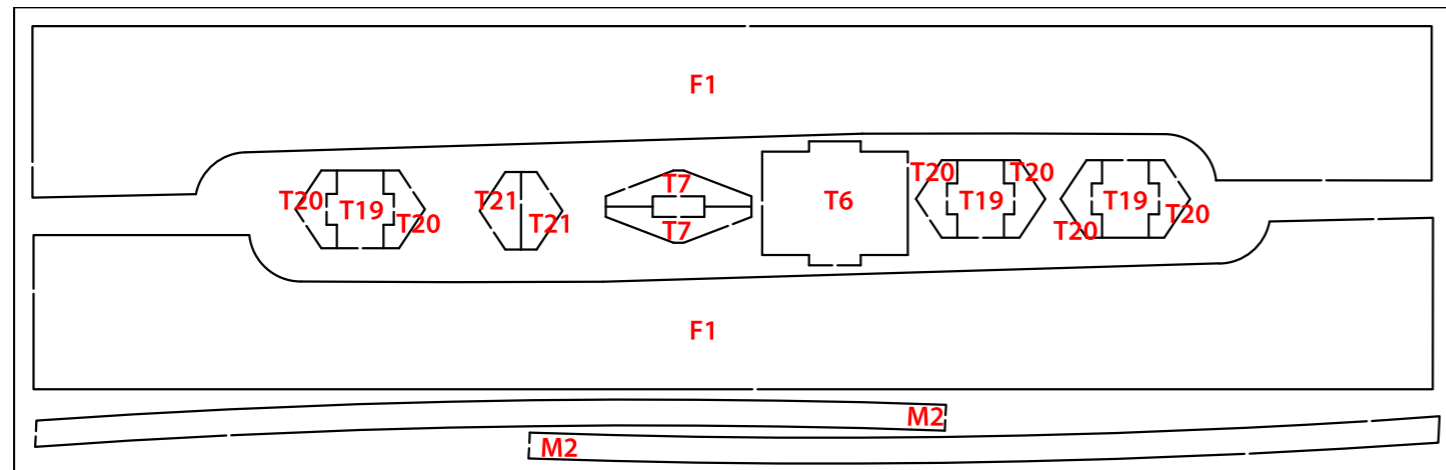

15006-10

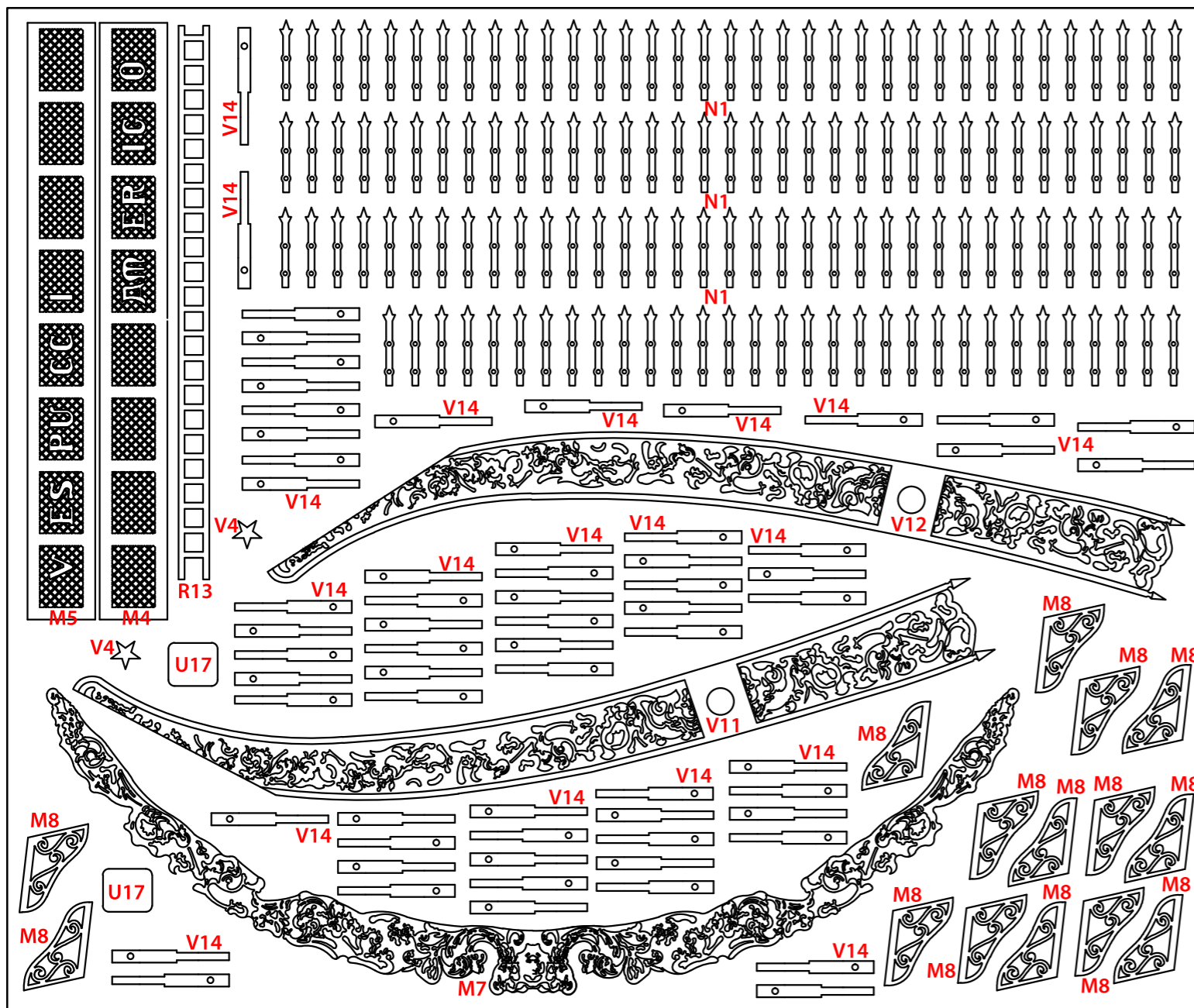

15006-12

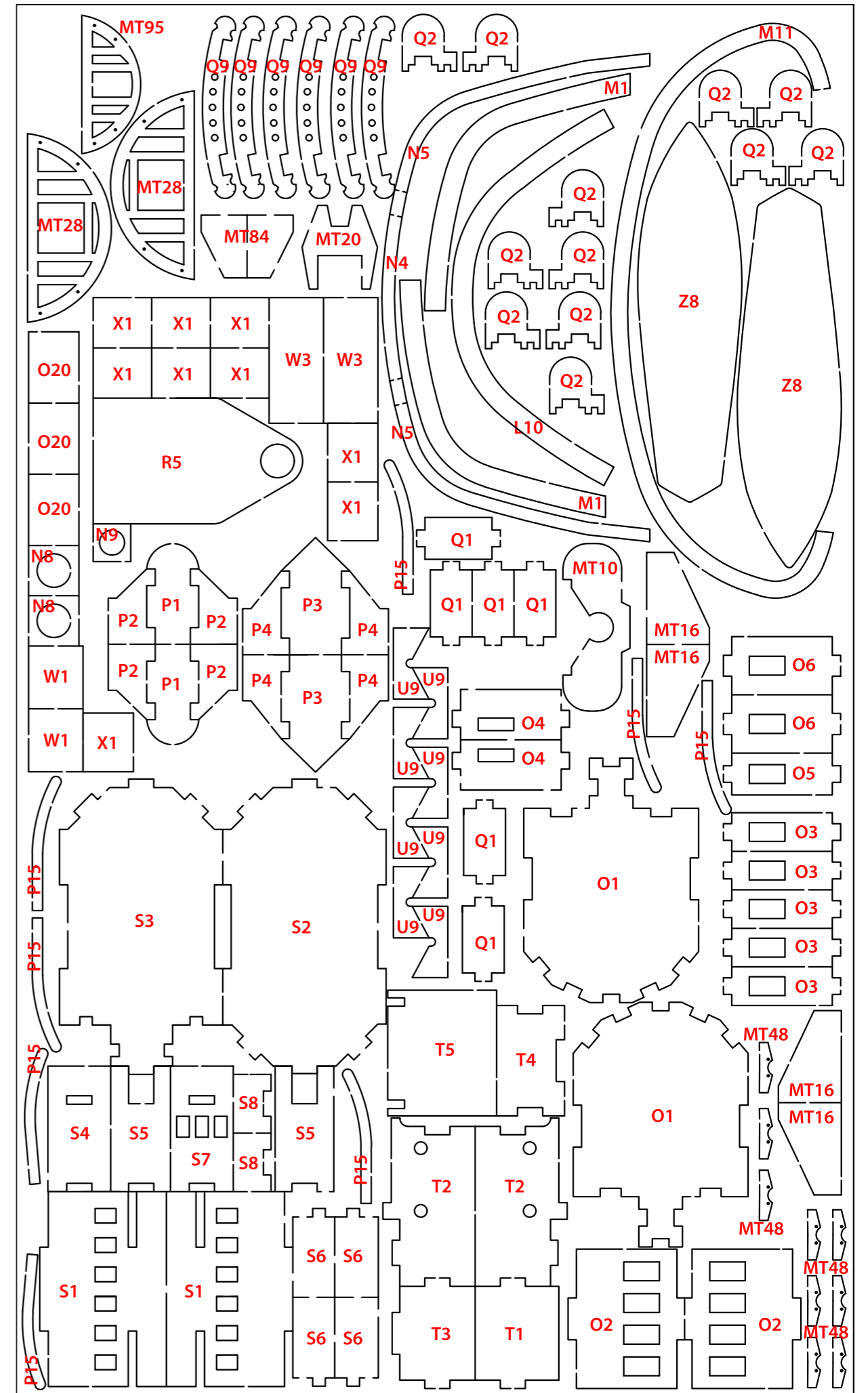

15006-11

Amerigo Vespucci

PL-01

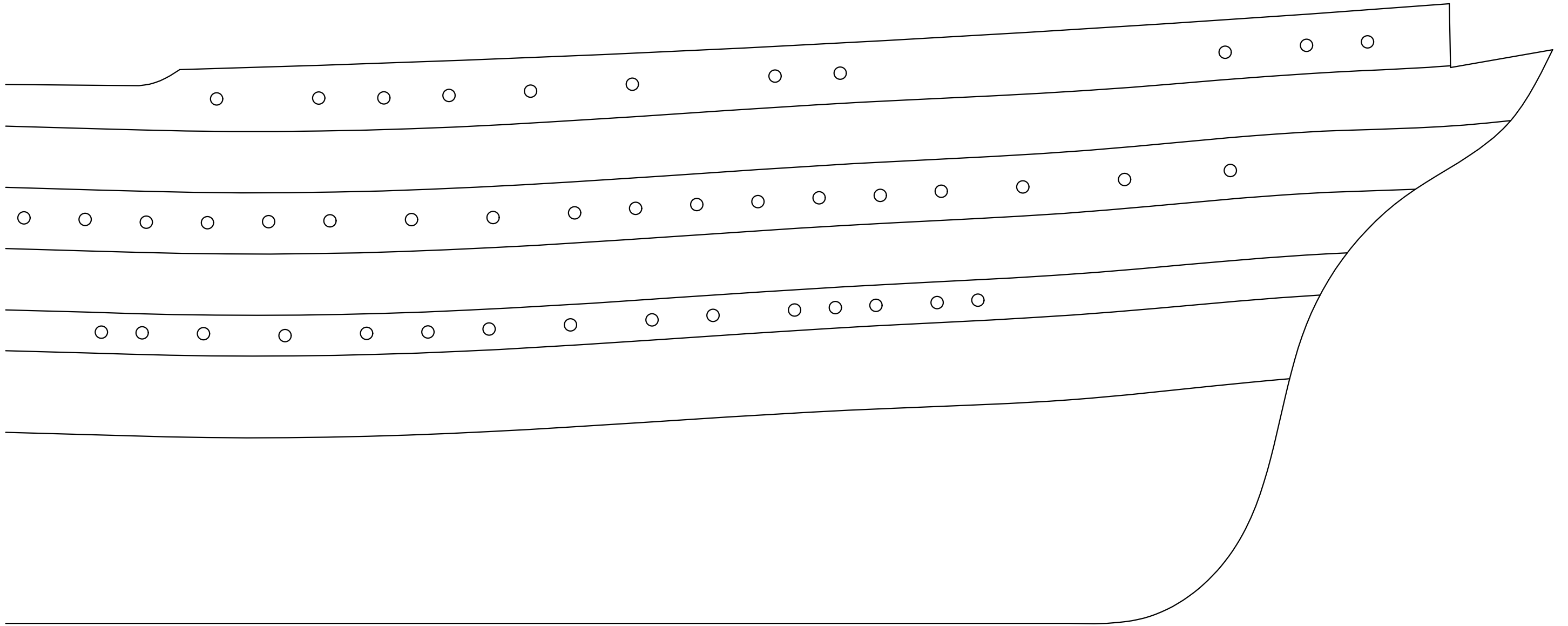

Amerigo Vespucci

PL-01

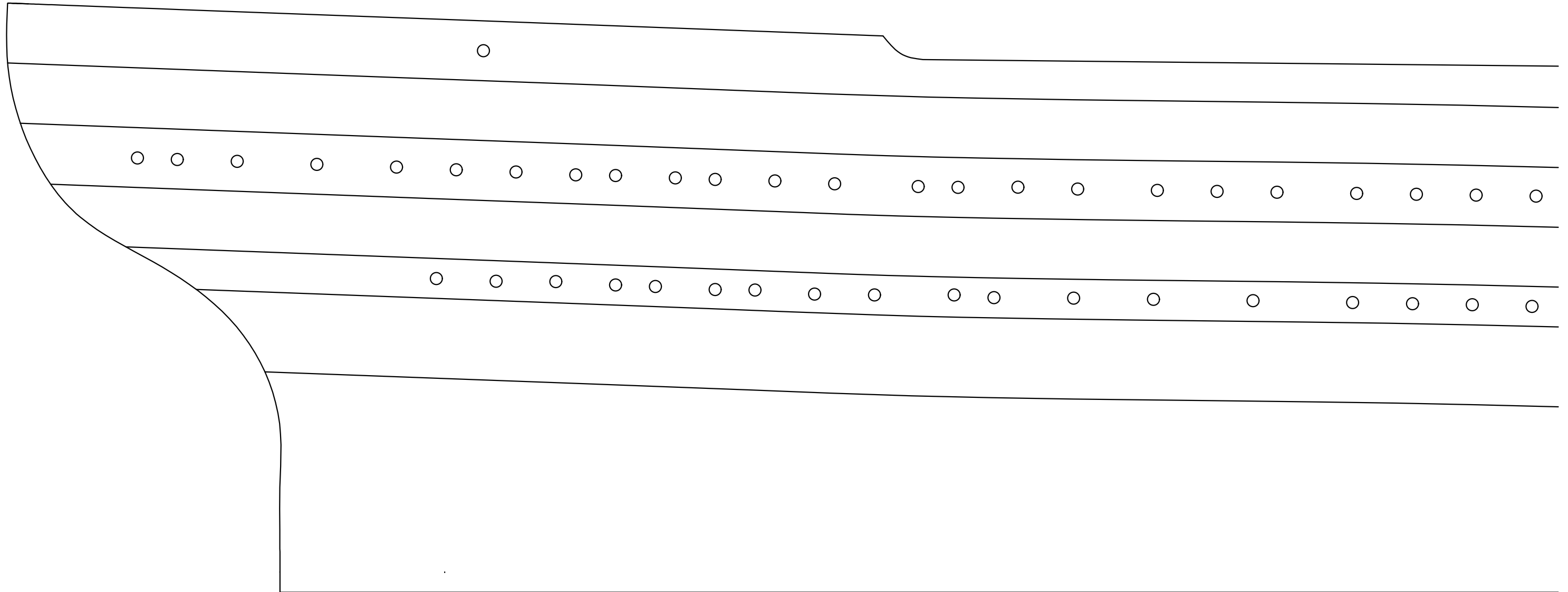

Amerigo Vespucci

PL-01

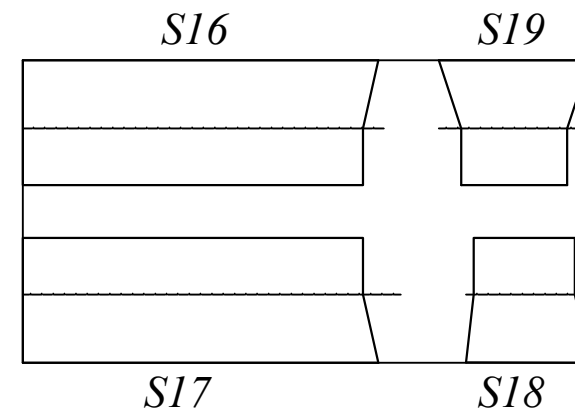
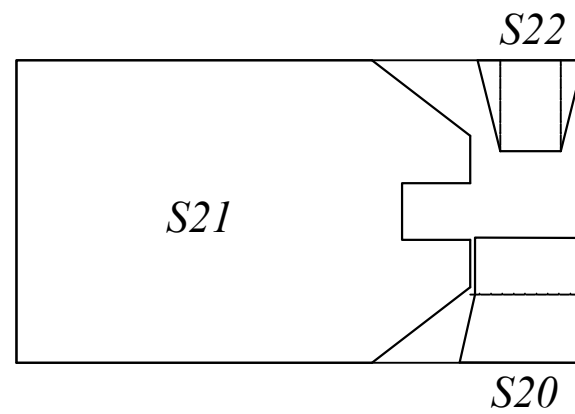
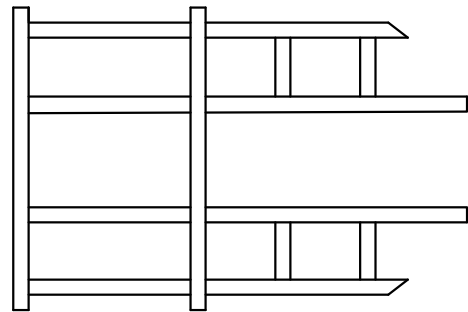
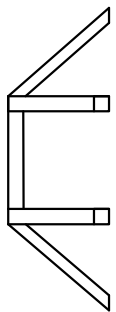
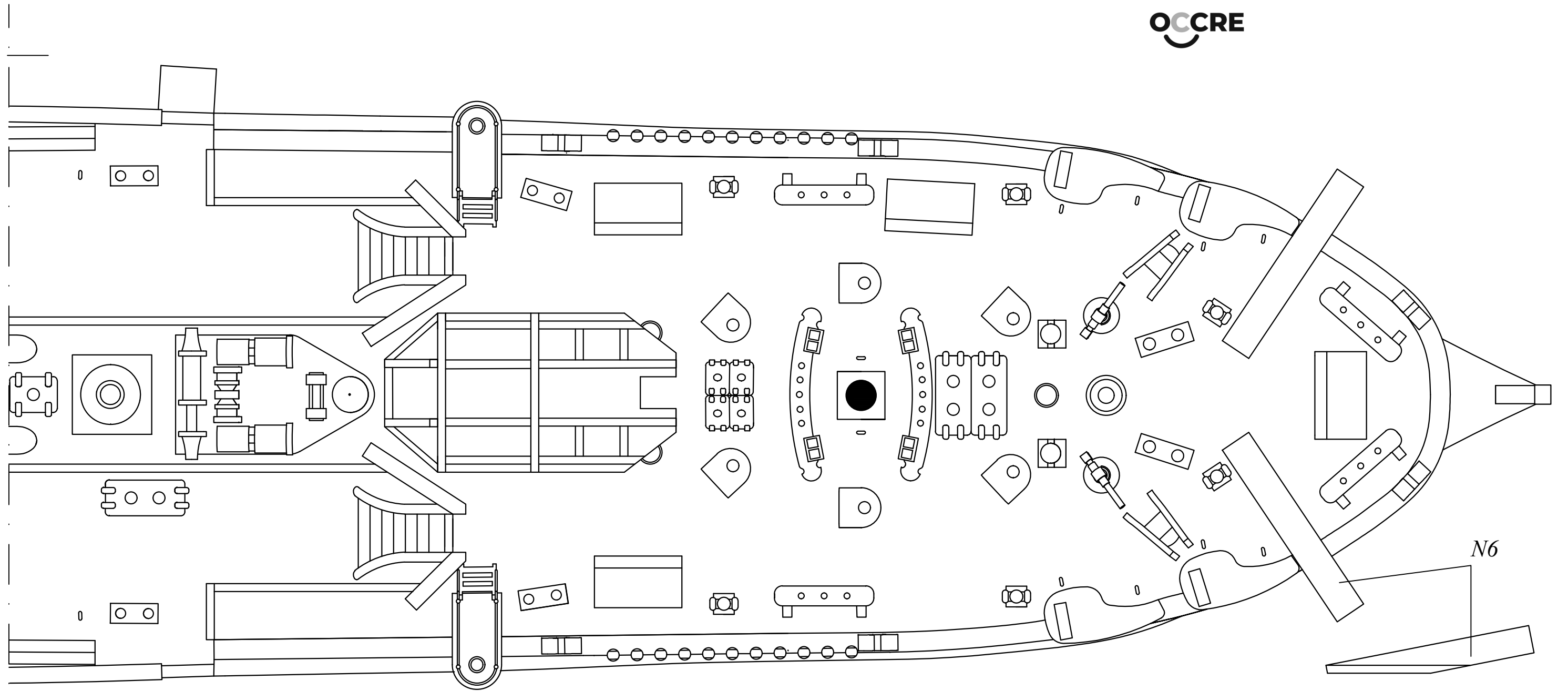

Amerigo Vespucci

PL-01

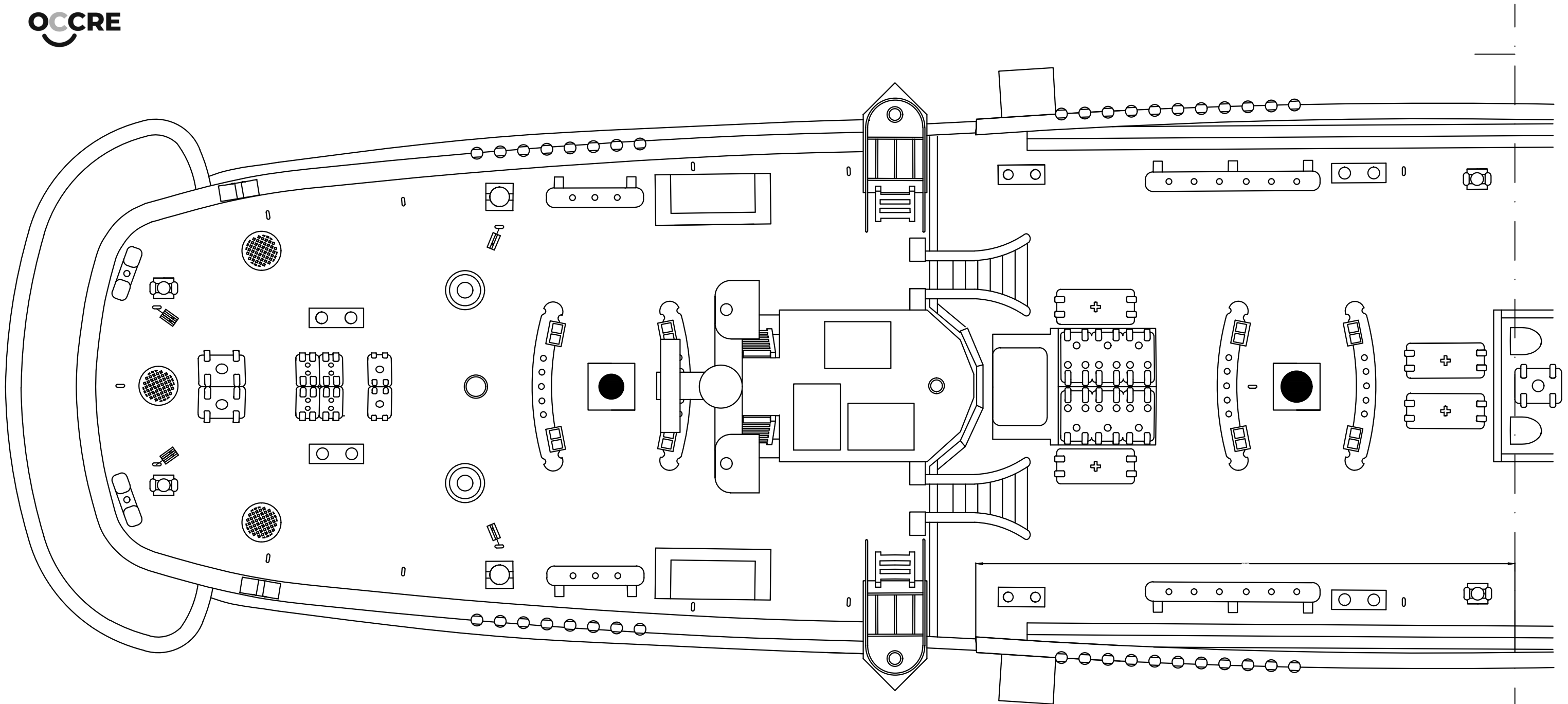

S12



Scale 1/1

Amerigo Vespucci

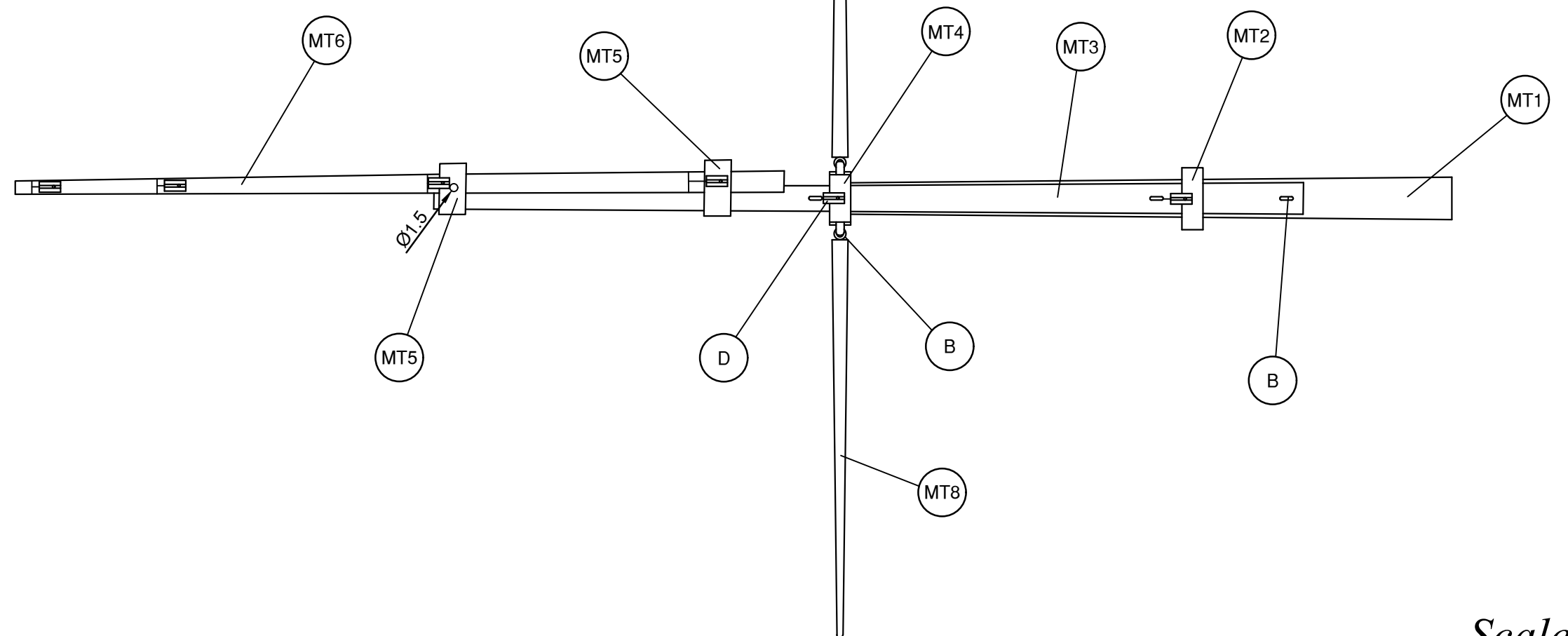
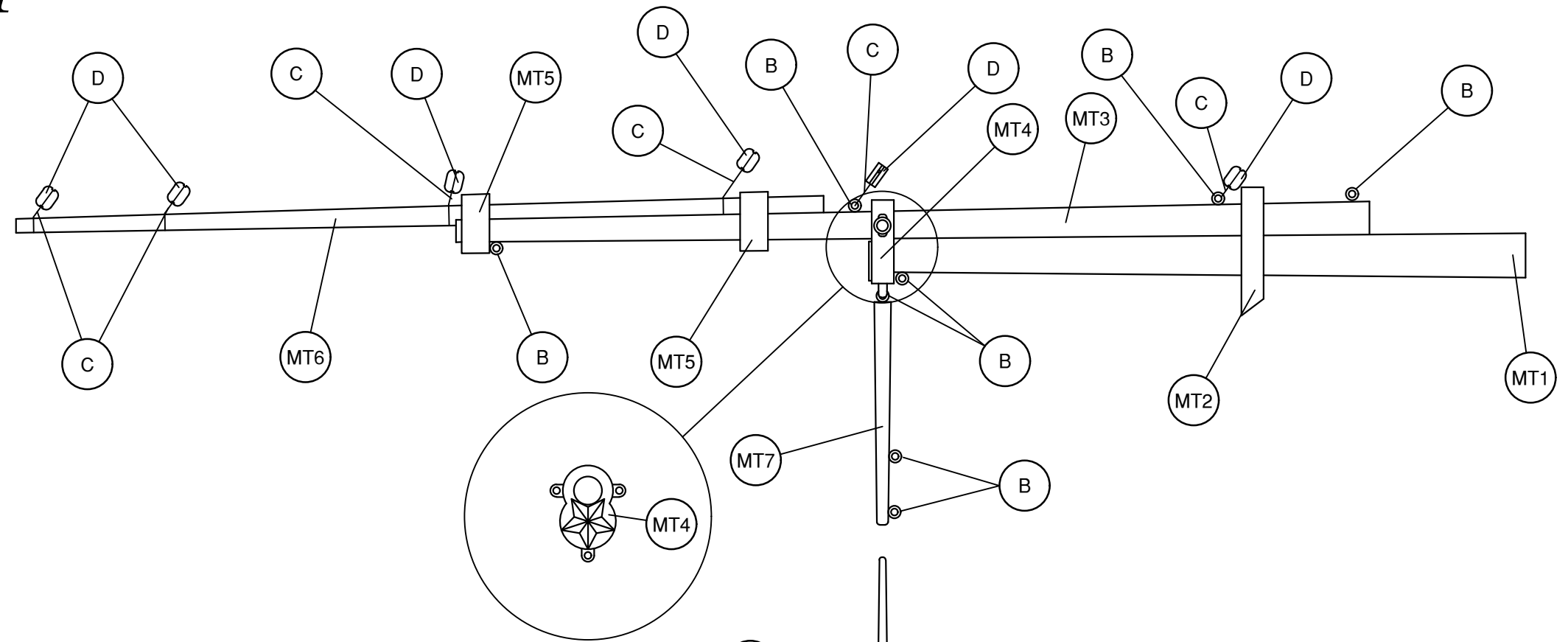
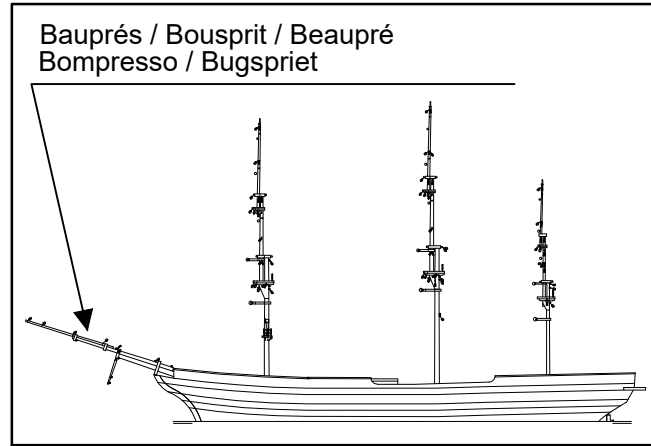

- | | |
|---------|-----------------------------|
| A | B |
| Punta | Cáncamo |
| Pins | Eyebolts |
| Punte | Caviglia di ferro ad anello |
| Stifte | Tragöse |
| Pointes | Piton à oeil |

- | | |
|------------|---------------|
| D | E |
| Moton | Cuadernal |
| Blocks | Double blocks |
| Bozzello | Pastecca |
| Blockrolle | Block |
| Poulie | Poulie double |

- | | |
|--------|---------------|
| H | J |
| Anilla | Cabilla |
| Rings | Belaying Pins |
| Anello | Caviglia |
| Öse | Rundeisen |
| Oeil | Cheville |



Amerigo Vespucci

Palo trinquete / Fore mast / Mât de misaine
Albero trinchetto / Fockmast

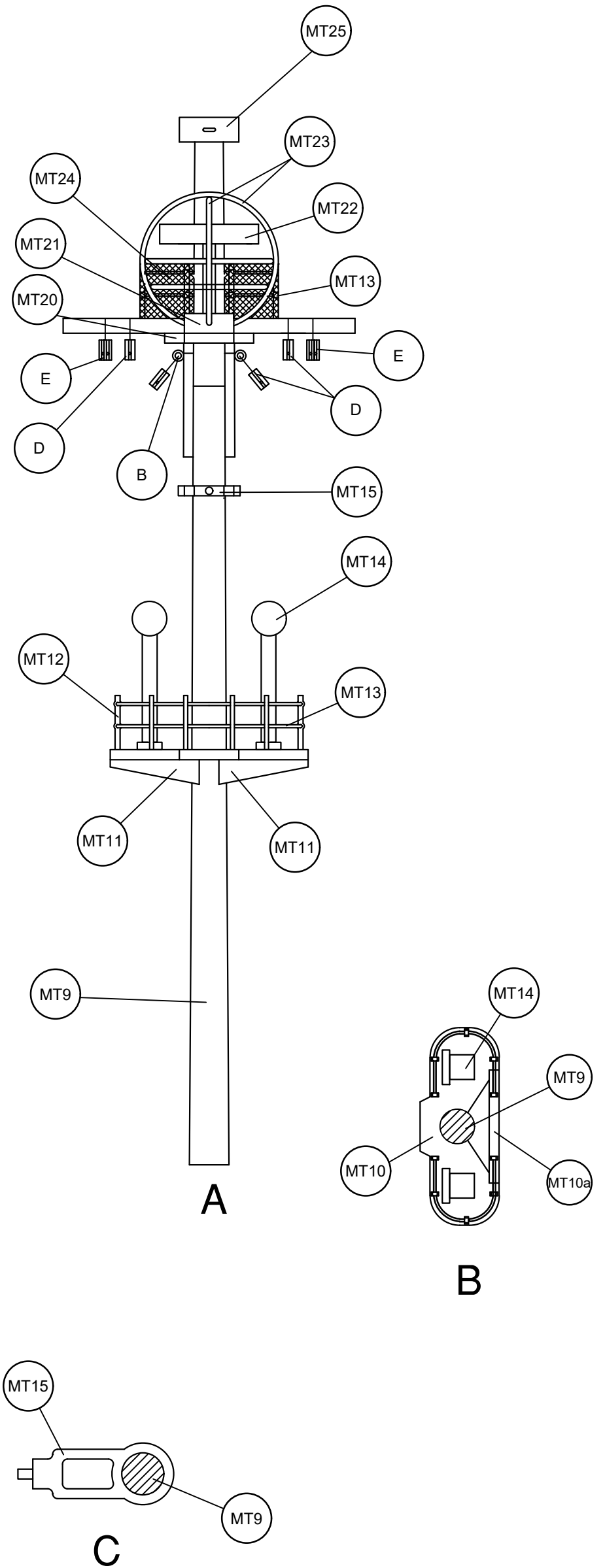
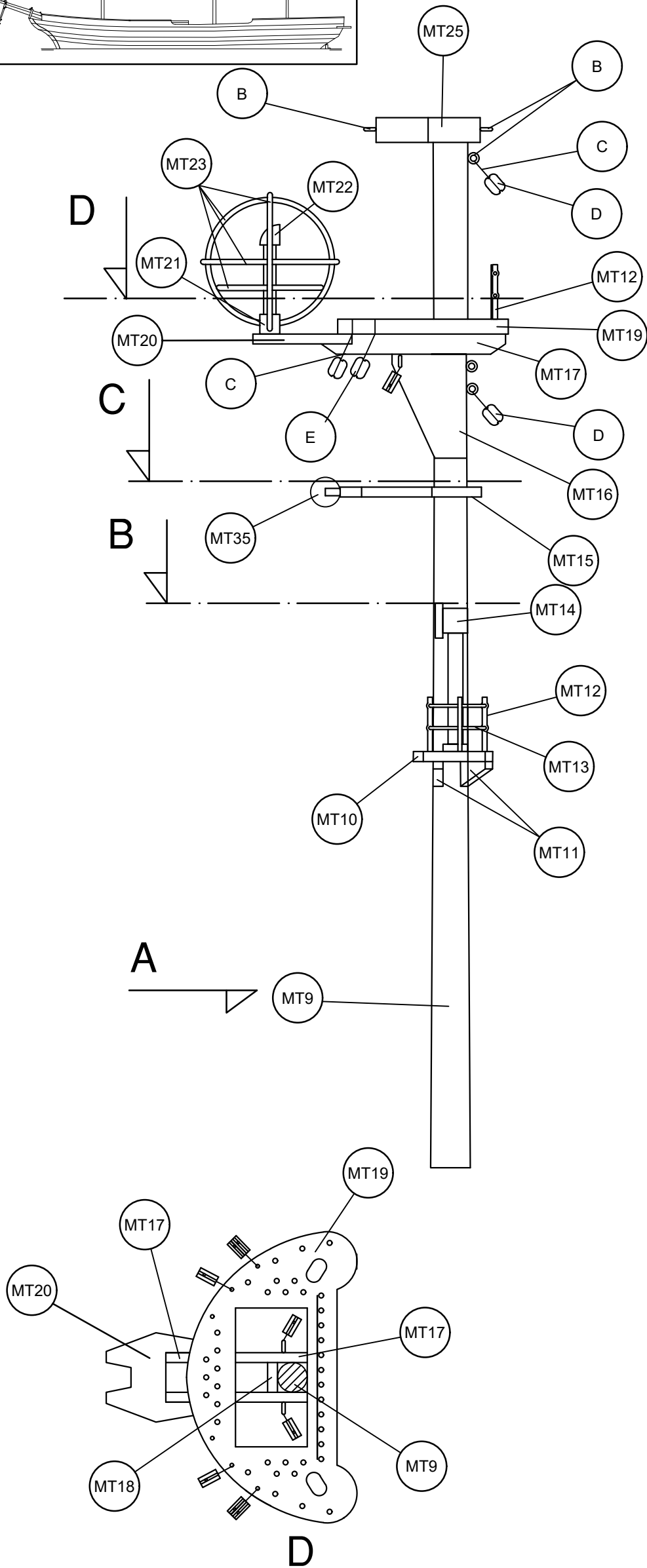
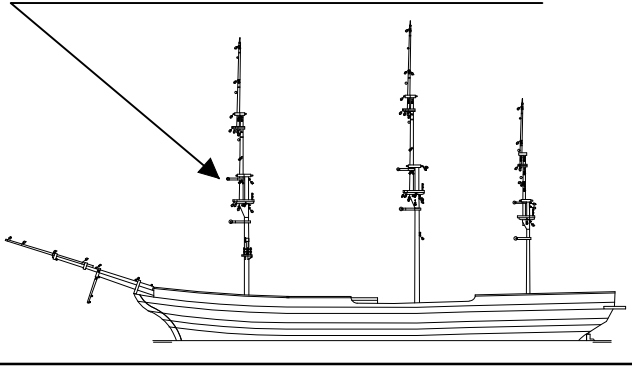

Amerigo Vespucci

Palo trinquete / Fore mast
Mât de misaine / Albero trinchetto
Fockmast

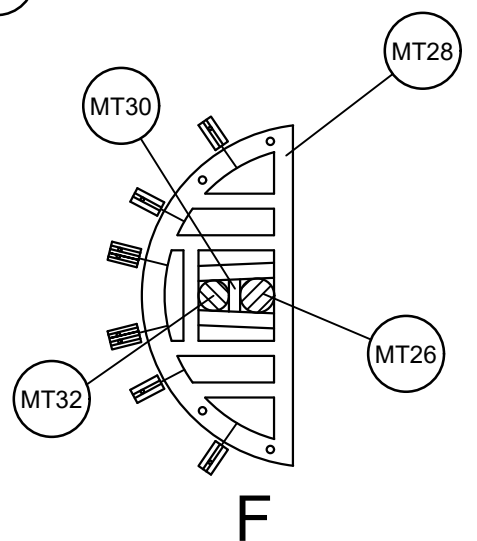
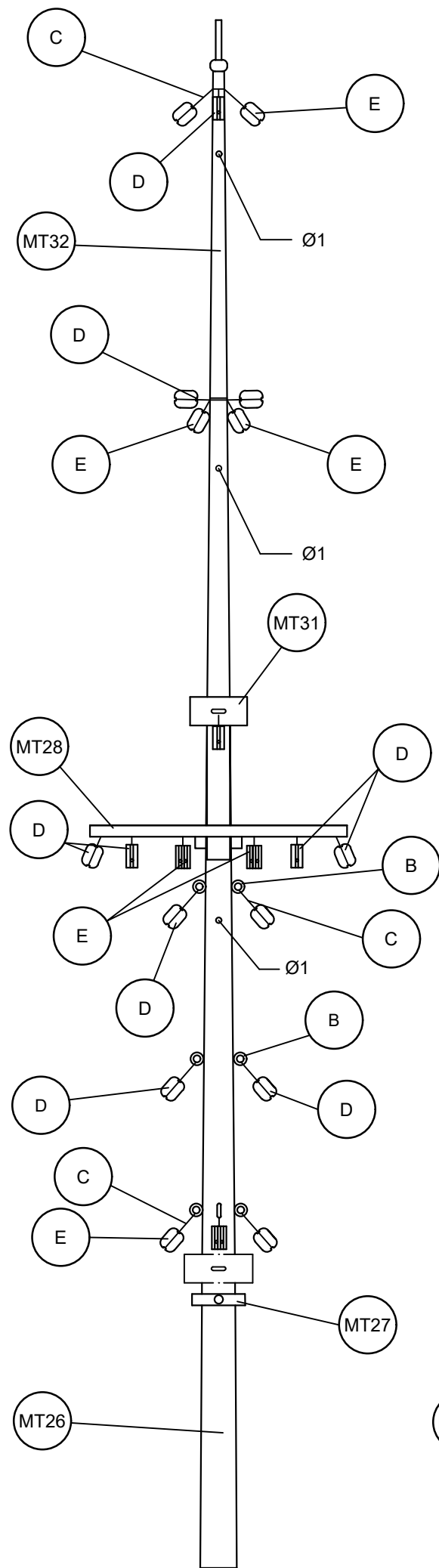
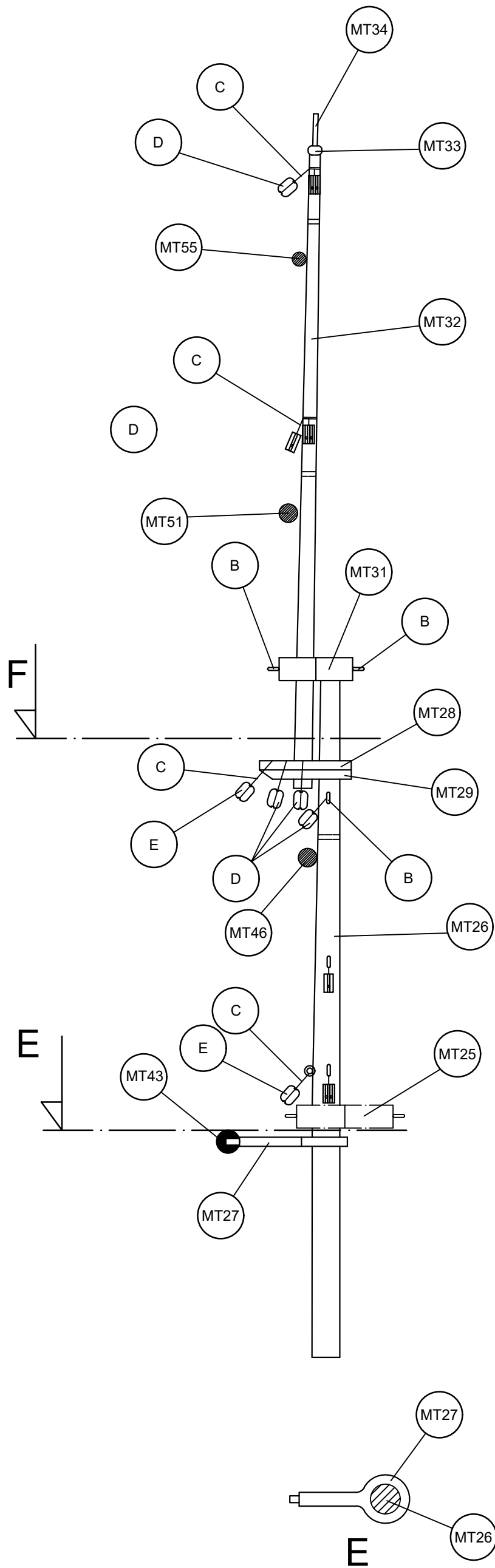

Amerigo Vespucci

Palo trinquete / Fore mast
Mât de misaine / Albero trinchetto
Fockmast

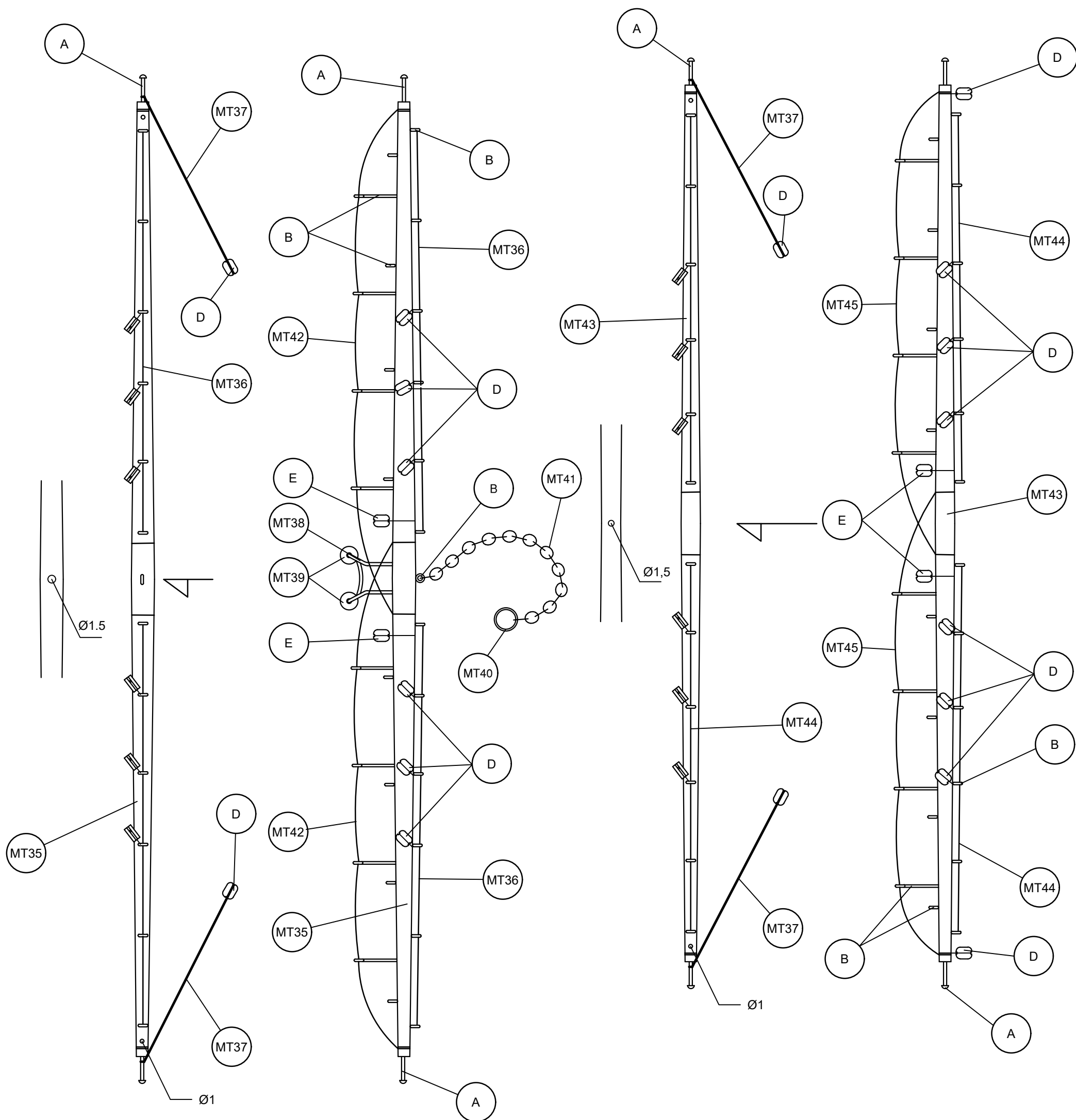

Amerigo Vespucci

Palo trinquete / Fore mast
Mât de misaine / Albero trinchetto
Fockmast

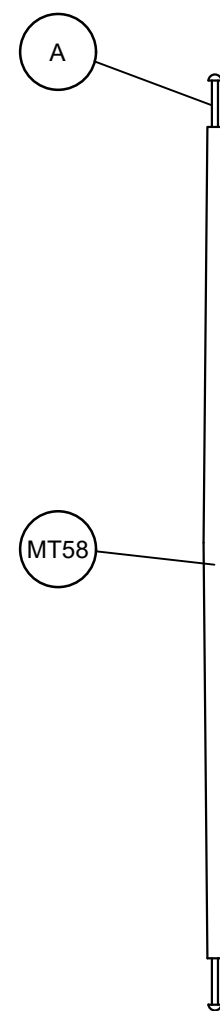
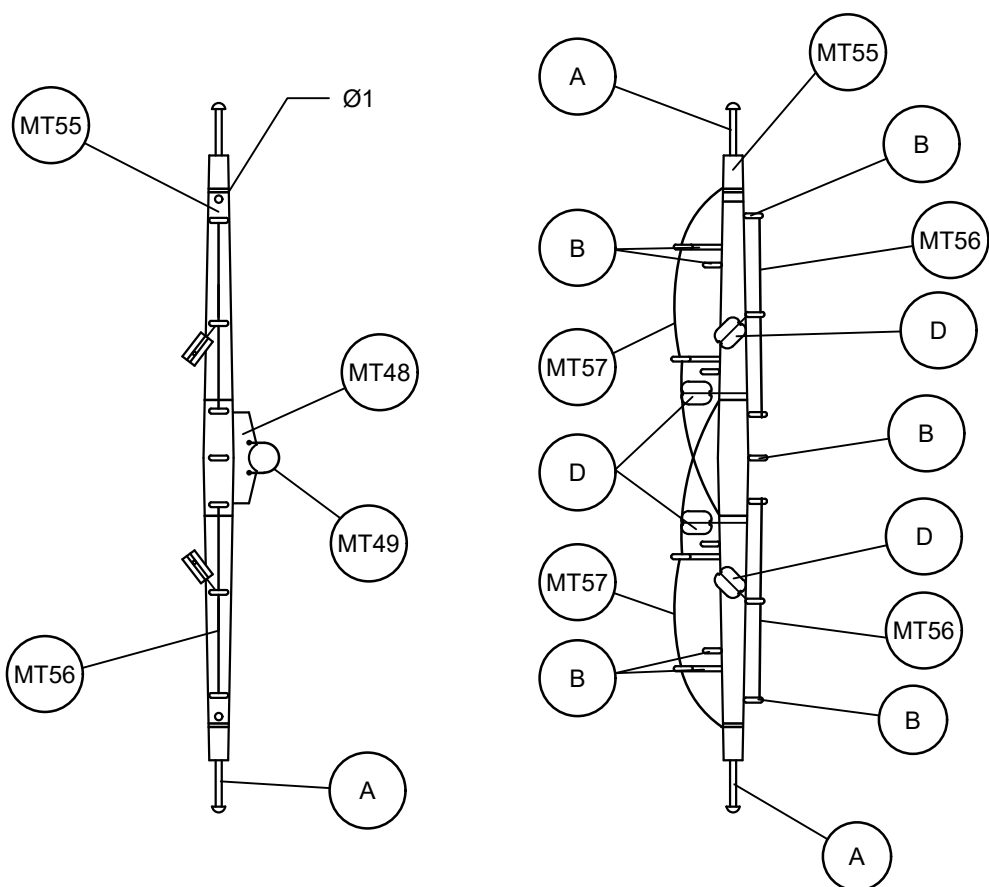
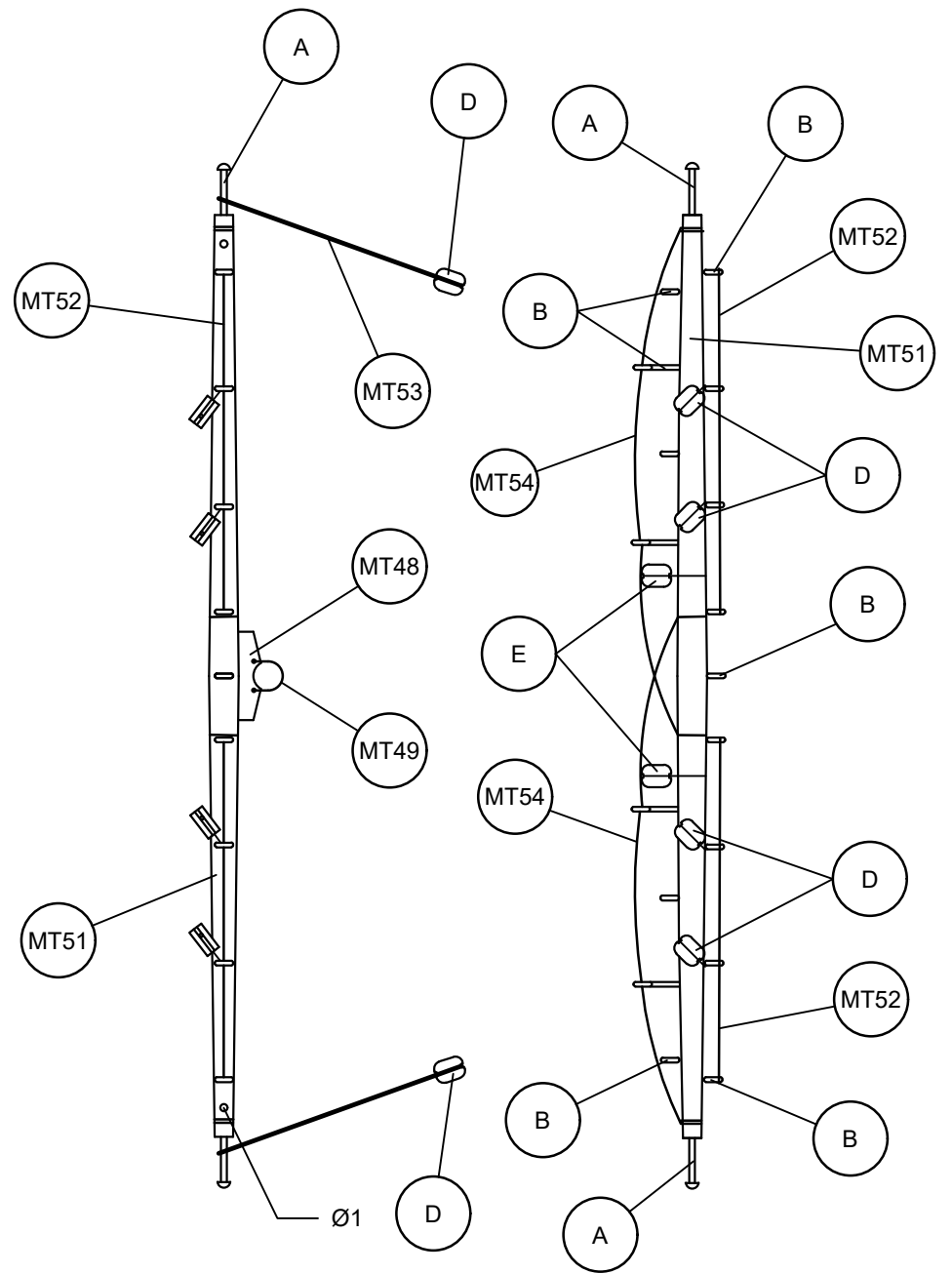
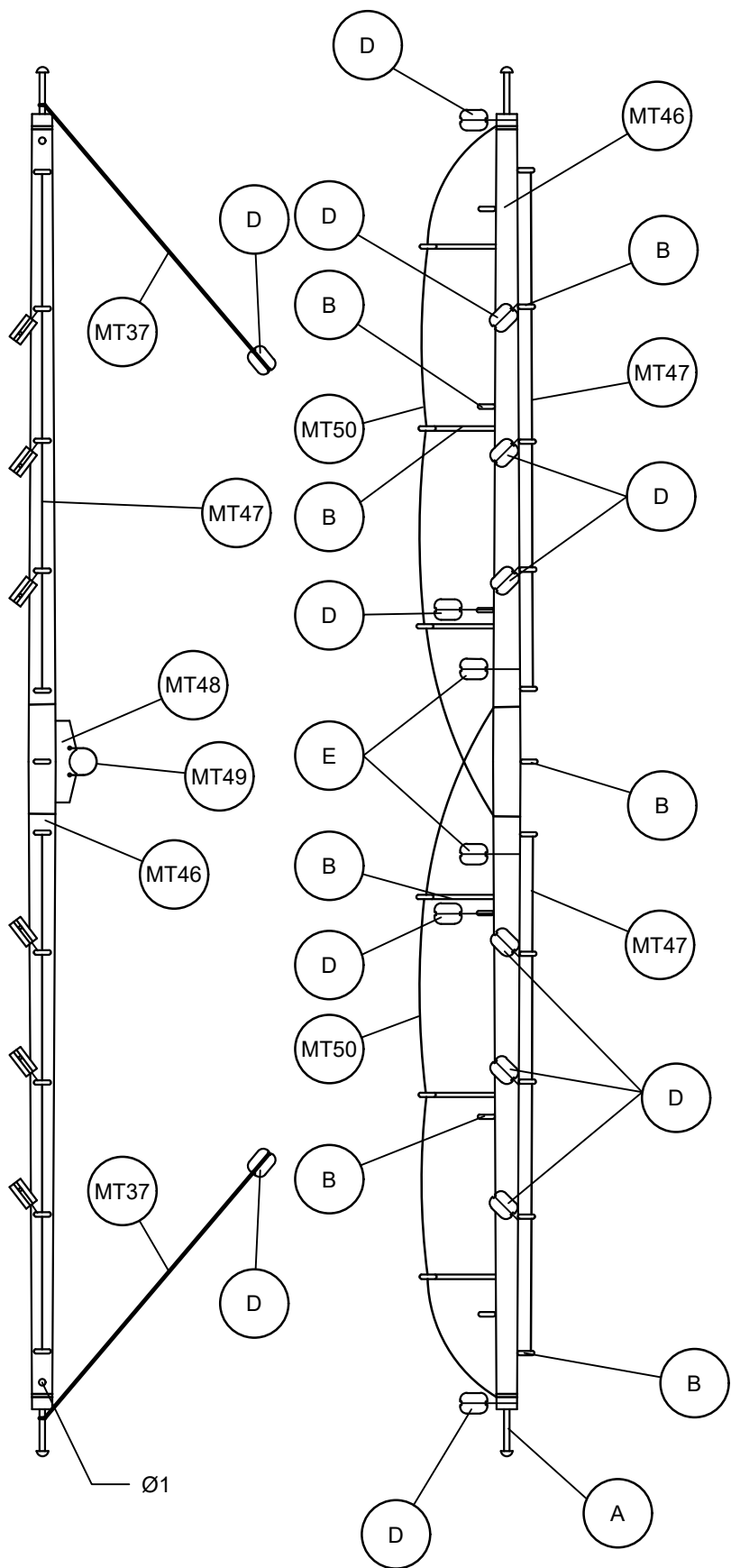

Amerigo Vespucci

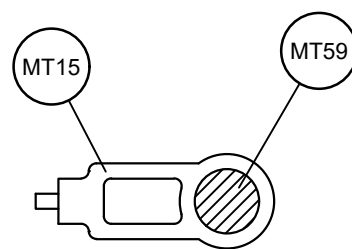
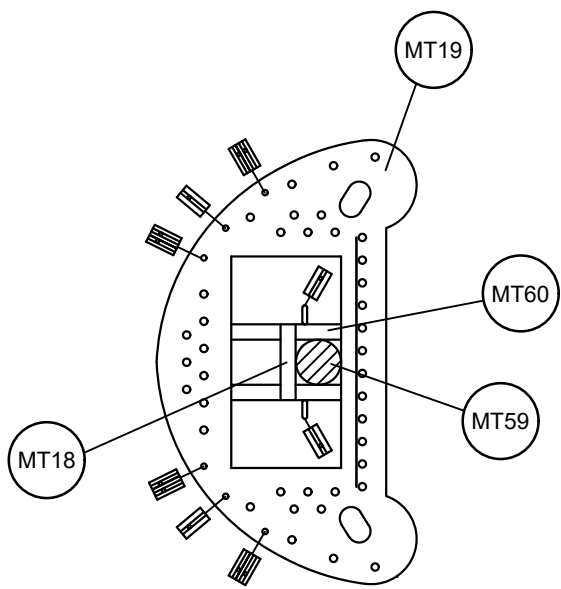
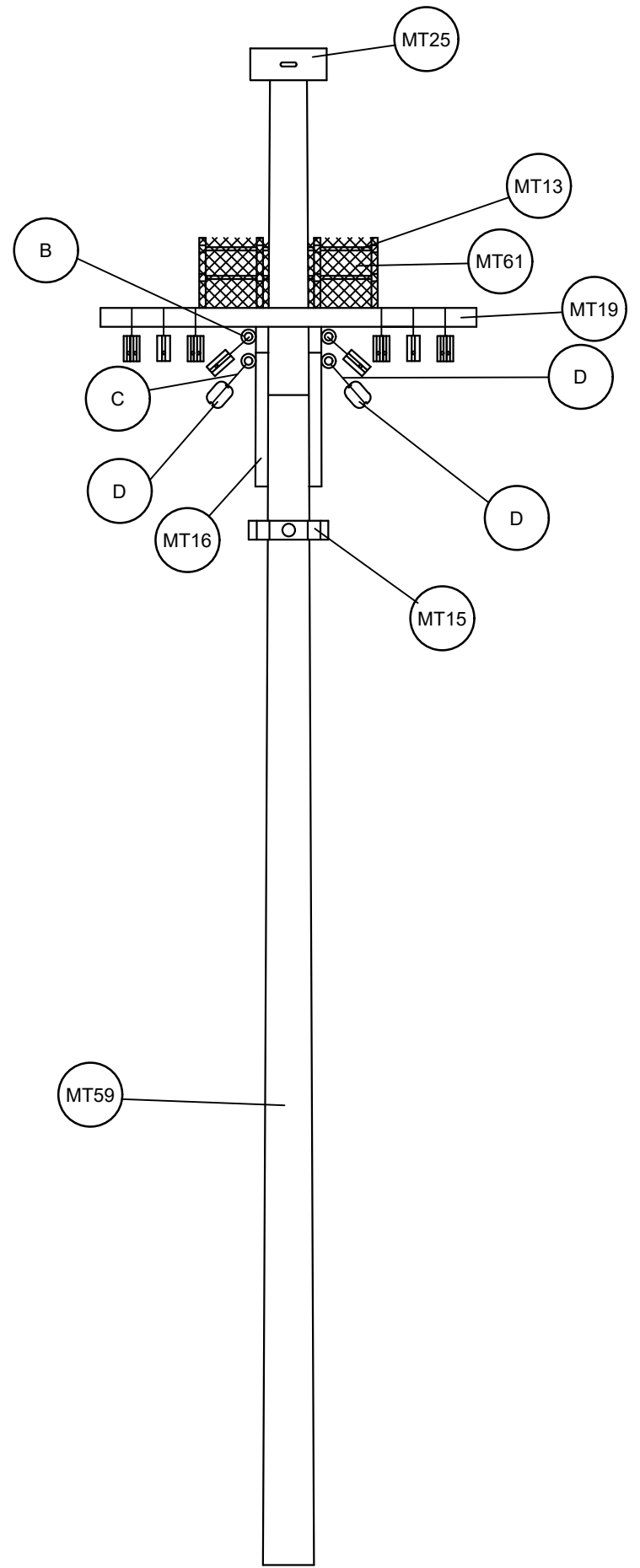
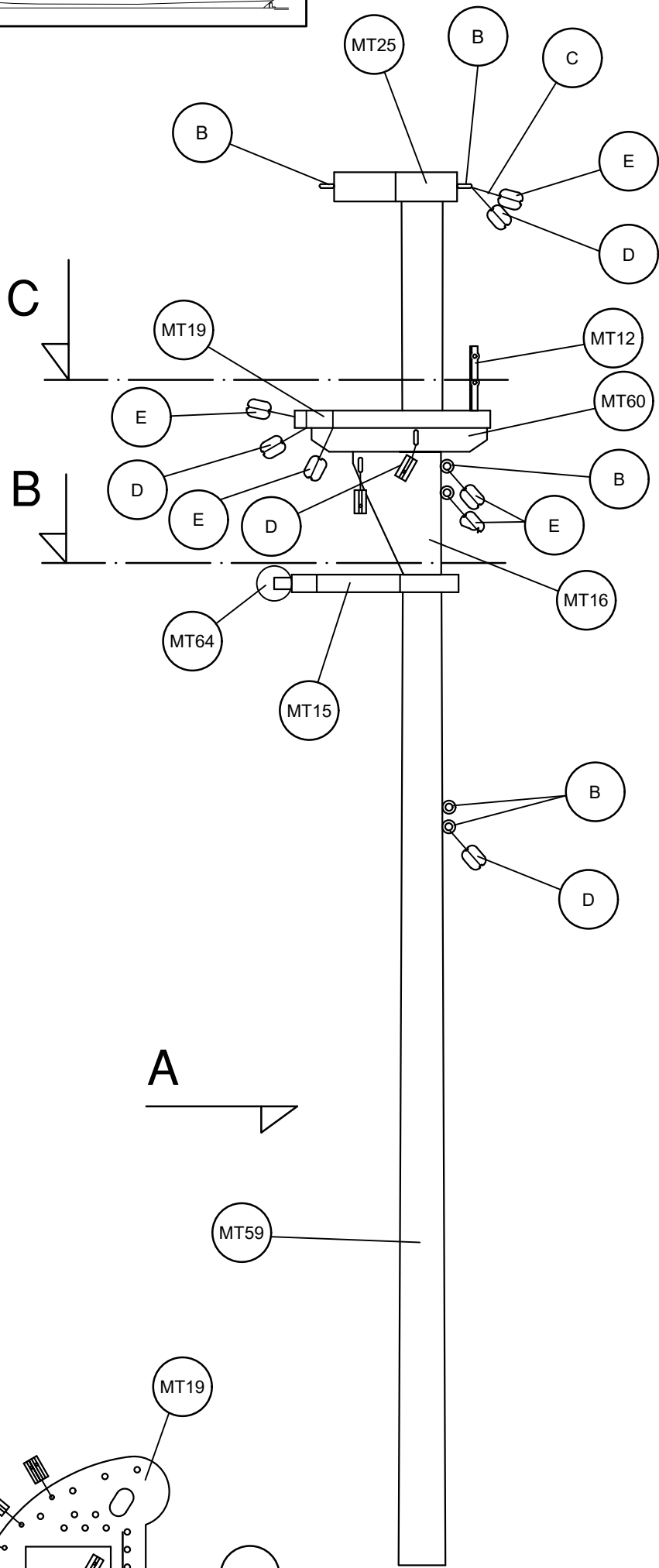
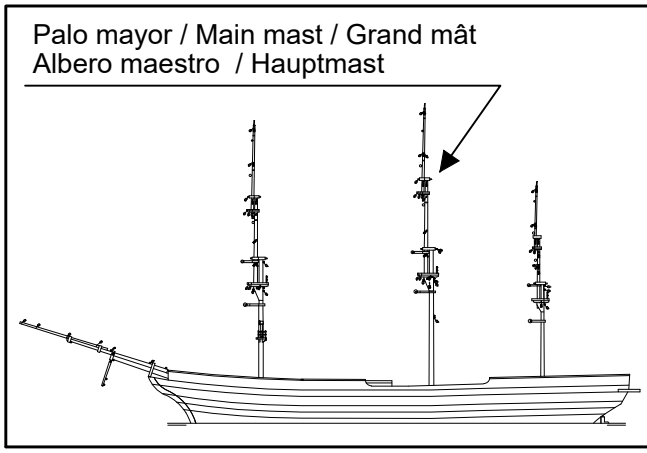

C

C

B

Amerigo Vespucci

Palo mayor / Main mast
Grand mât / Albero maestro
Hauptmast

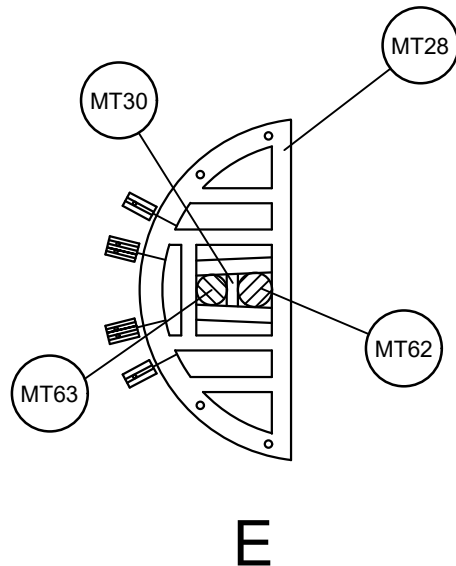
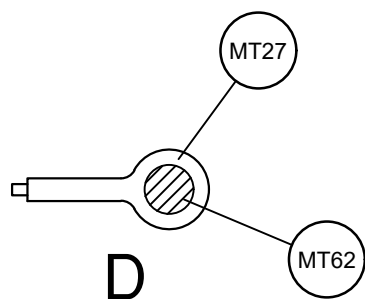
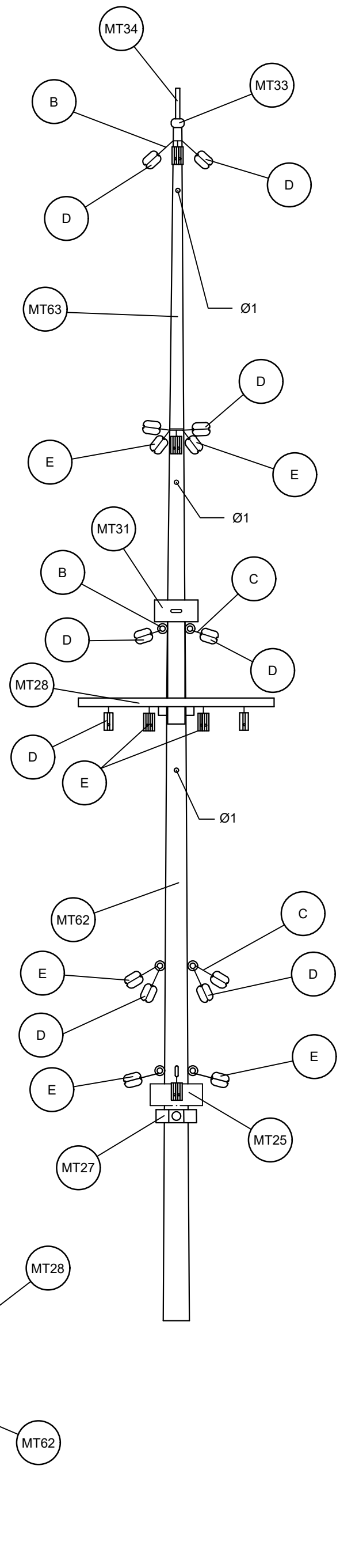
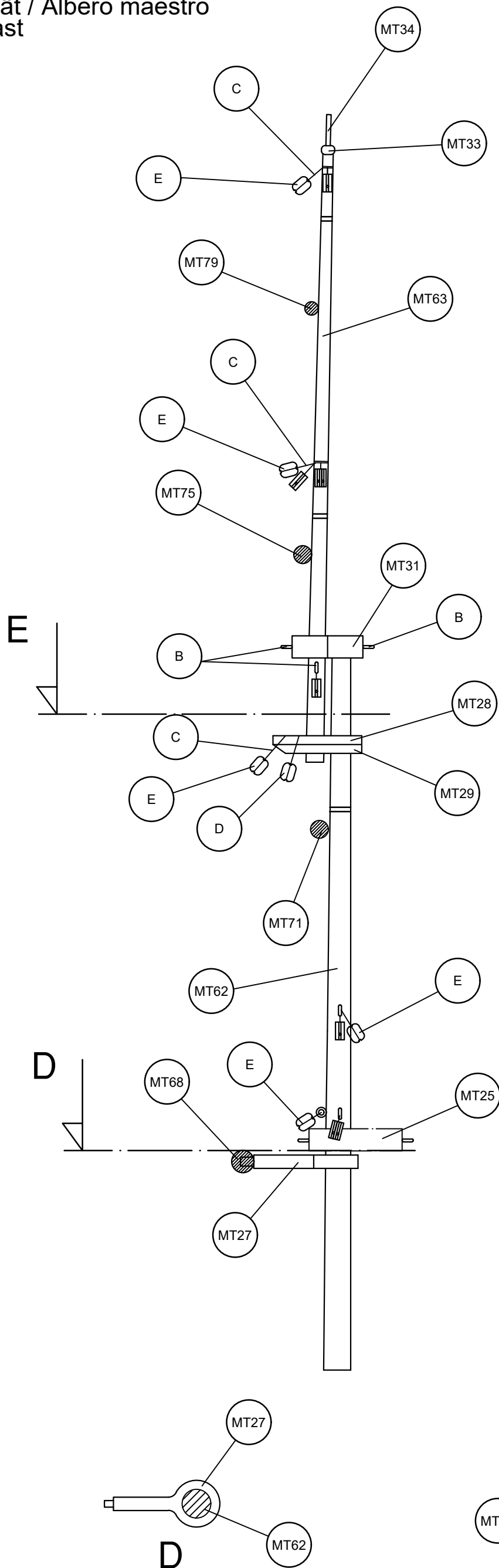

Amerigo Vespucci

Palo mayor / Main mast
Grand mât / Albero maestro
Hauptmast

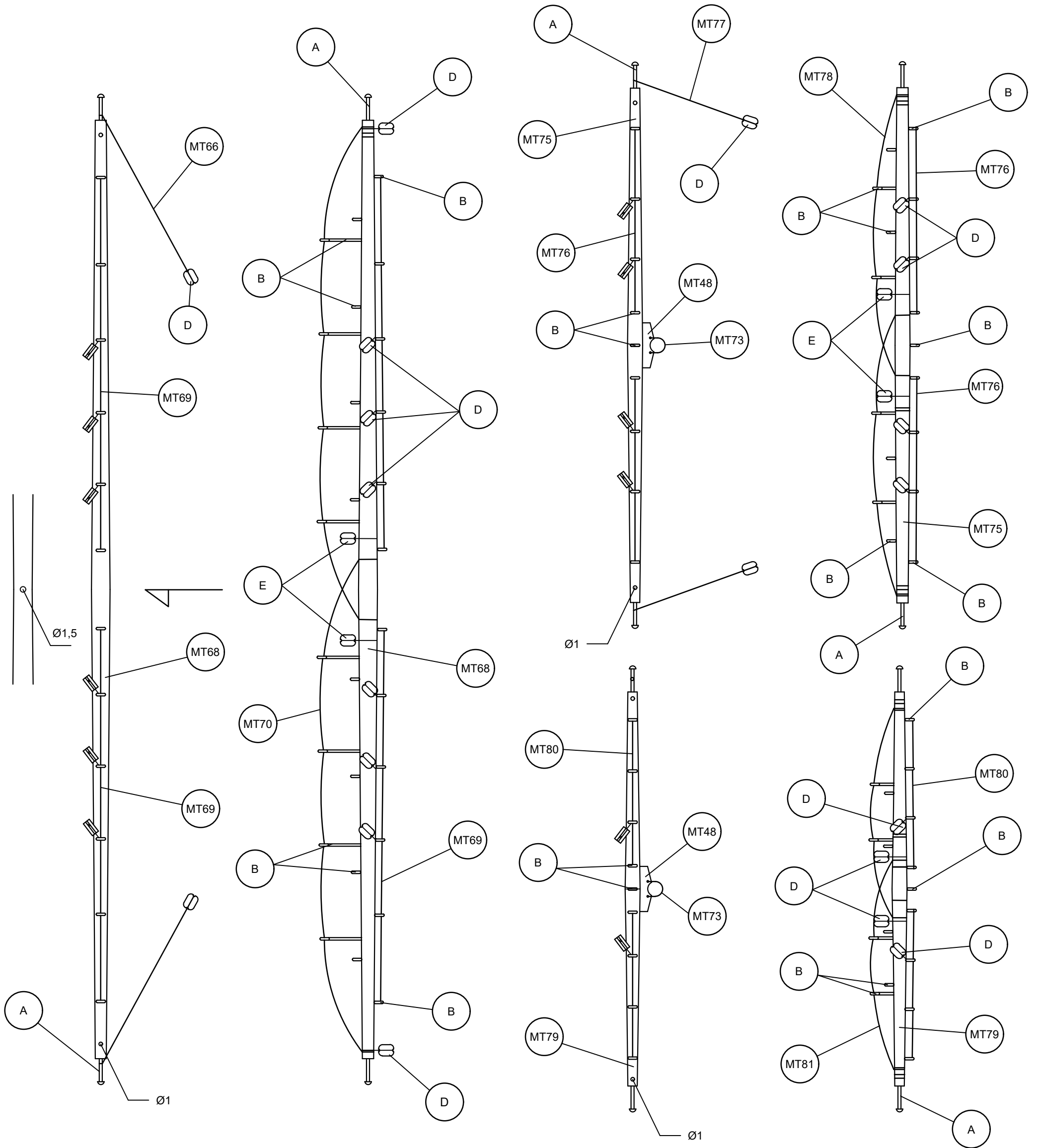

Amerigo Vespucci

Palo mayor / Main mast
Grand mât / Albero maestro
Hauptmast

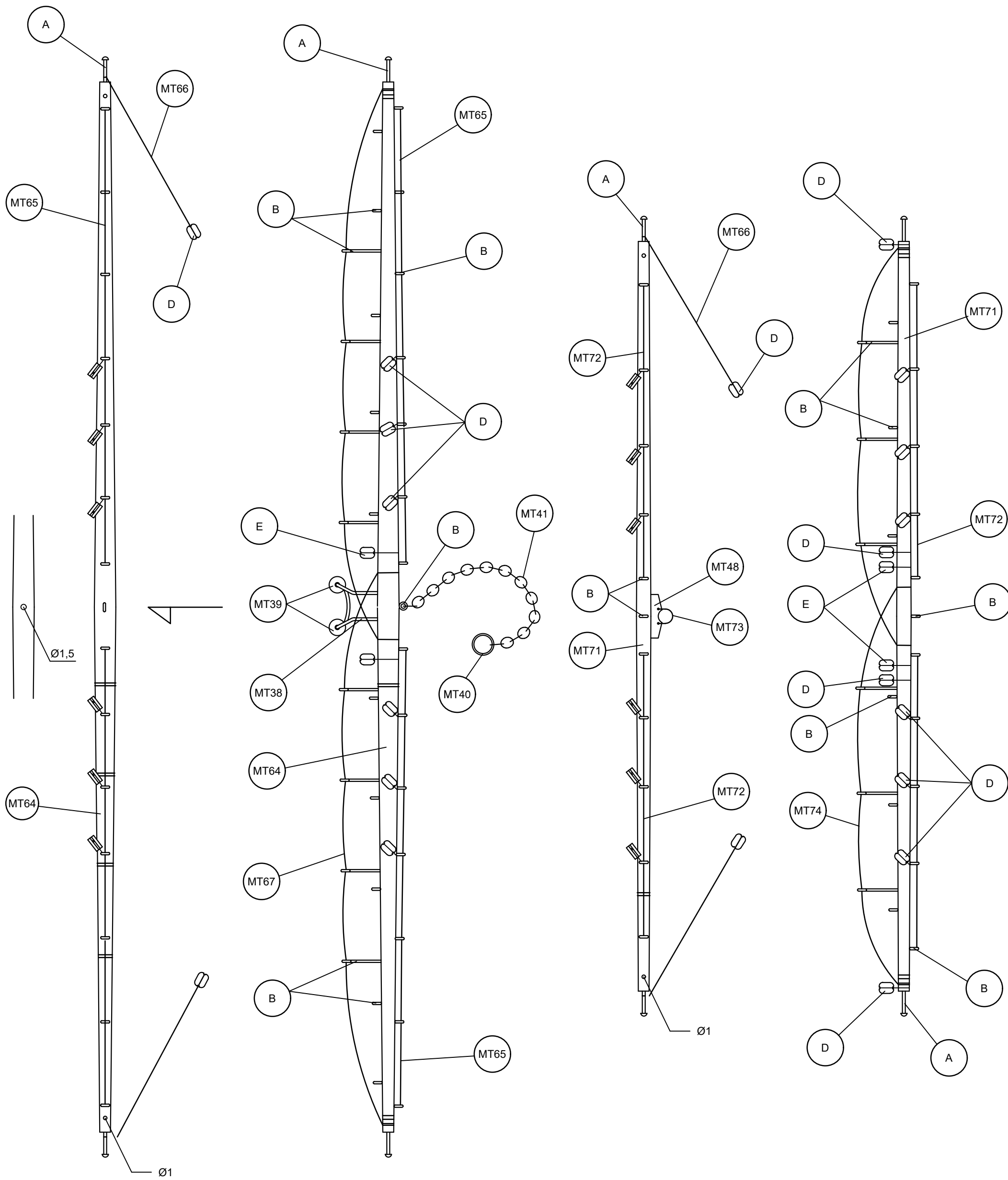

Amerigo Vespucci

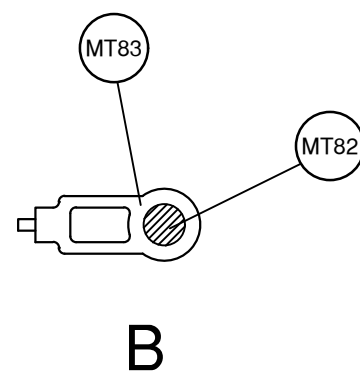
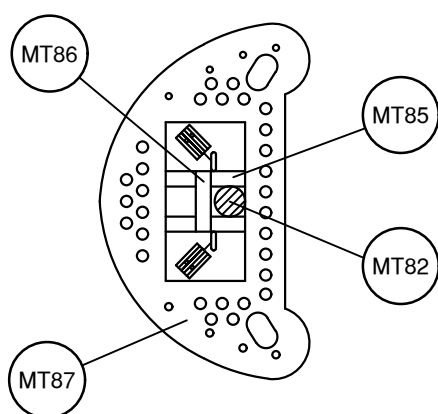
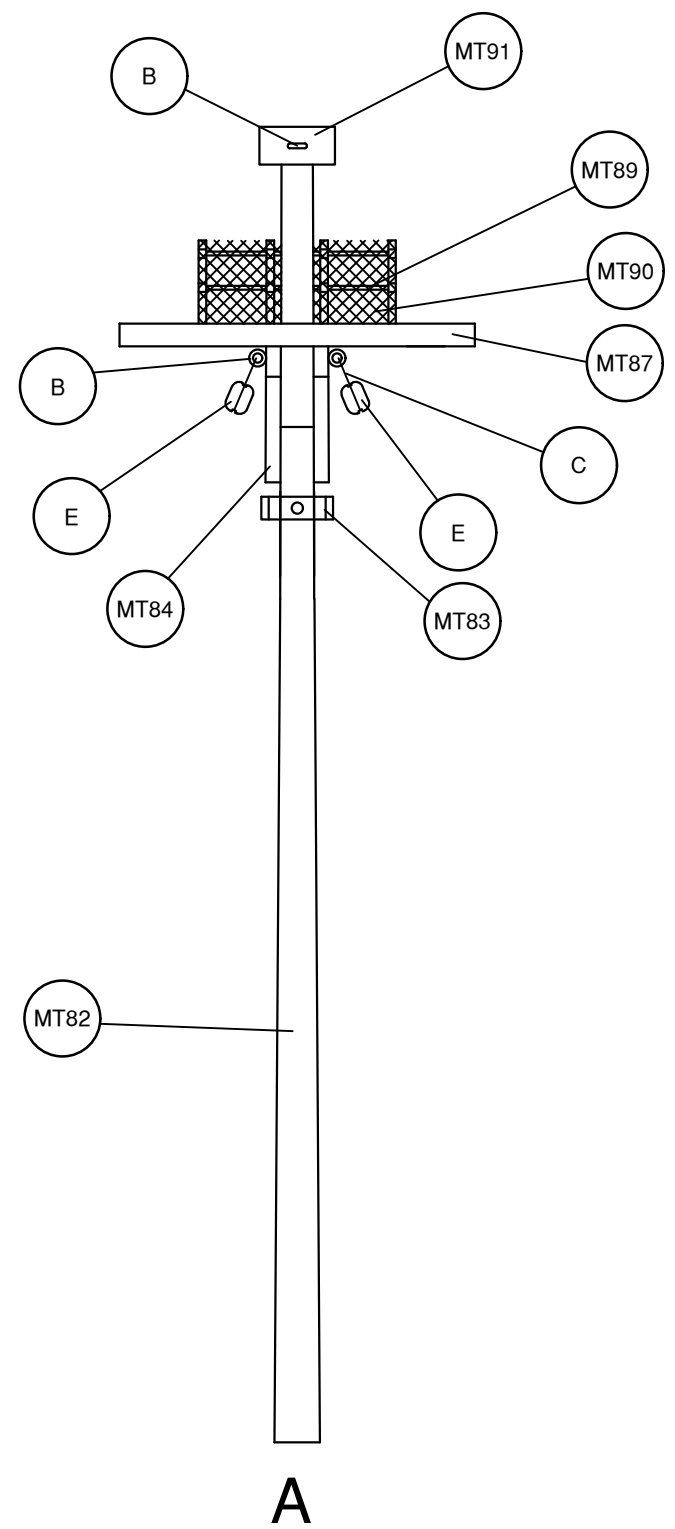
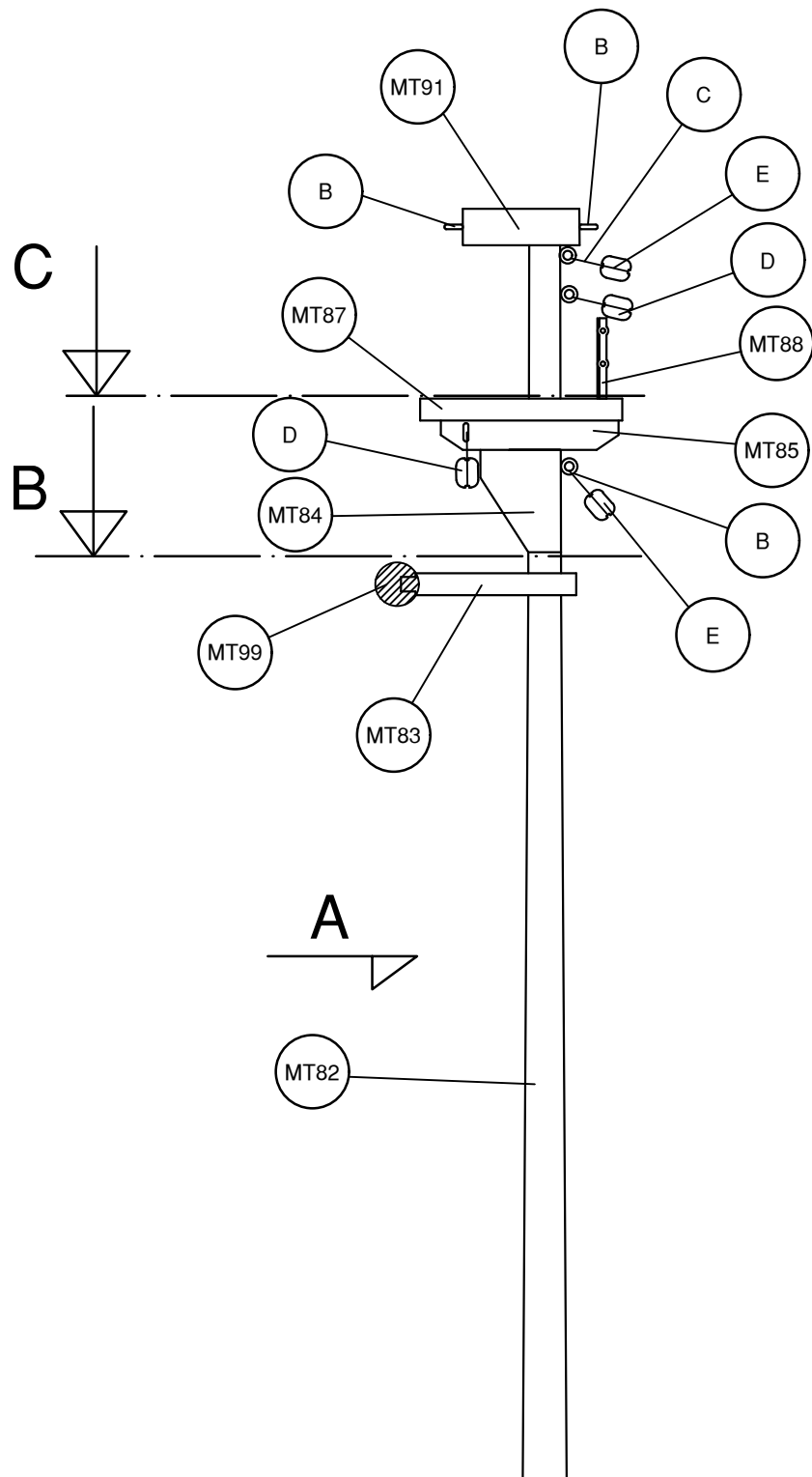
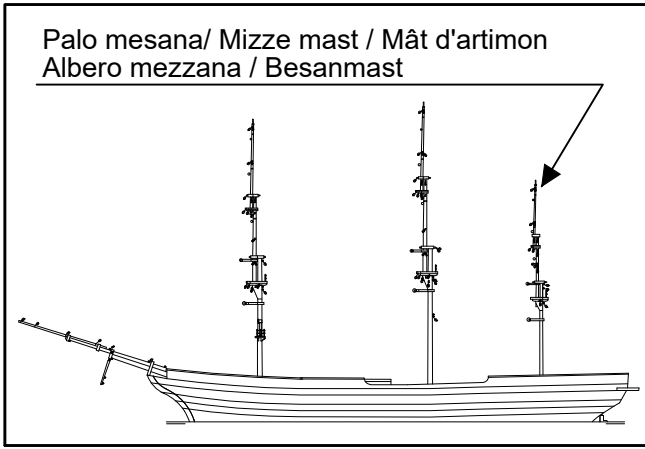

C

Amerigo Vespucci

Palo mesana/ Mizze mast / Mât d'artimon
Albero mezzana / Besanmast

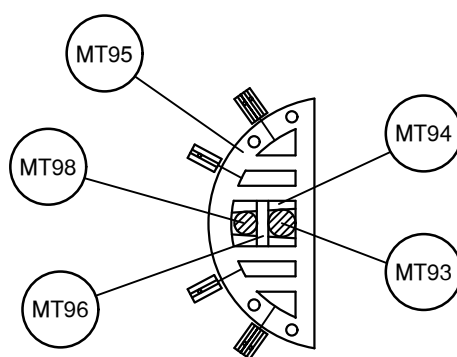
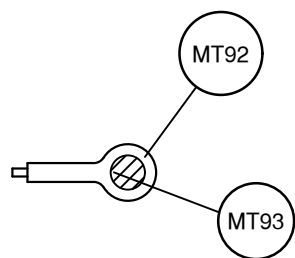
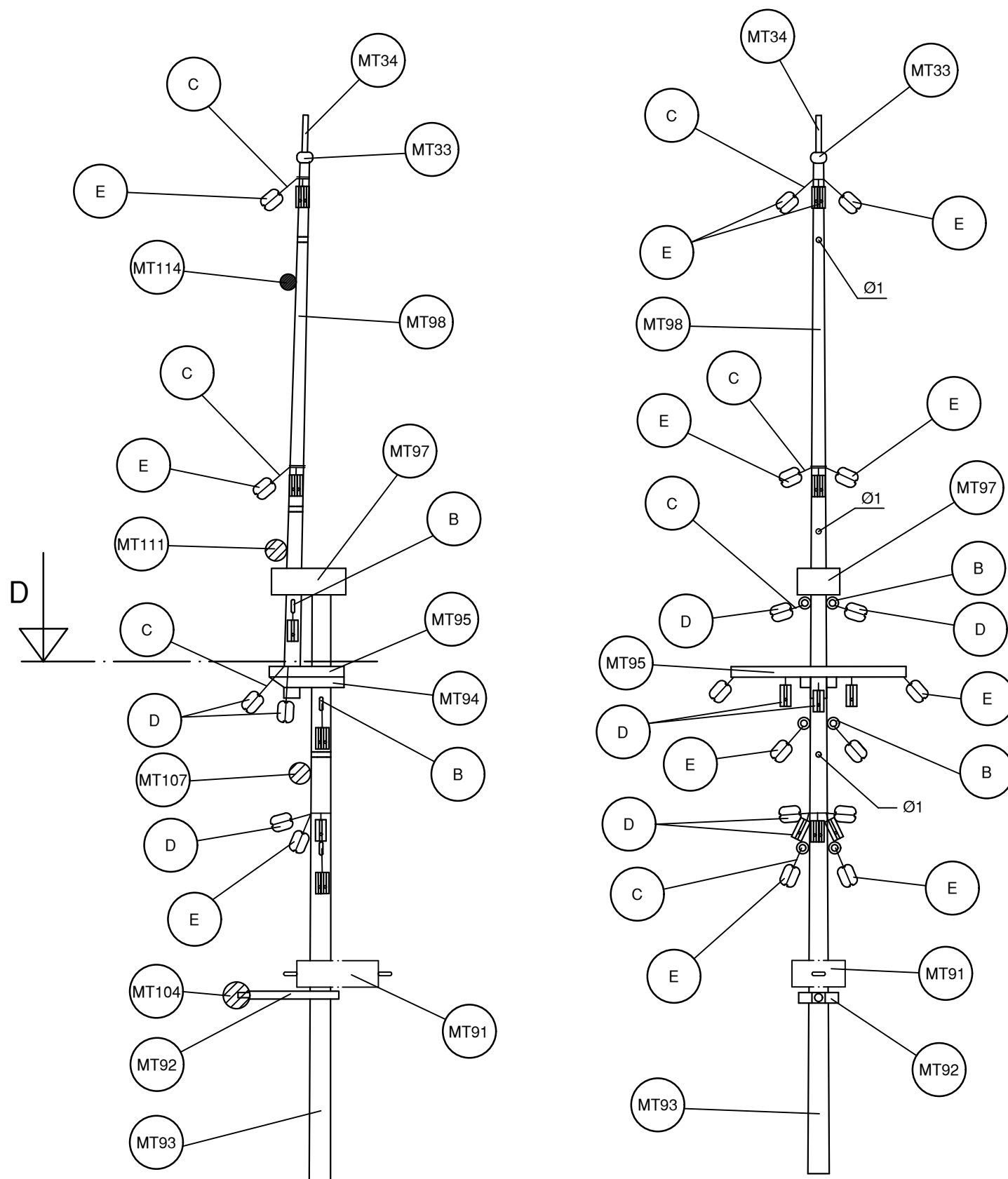

D

Amerigo Vespucci

Palo mesana/ Mizze mast / Mât d'artimon
Albero mezzana / Besanmast

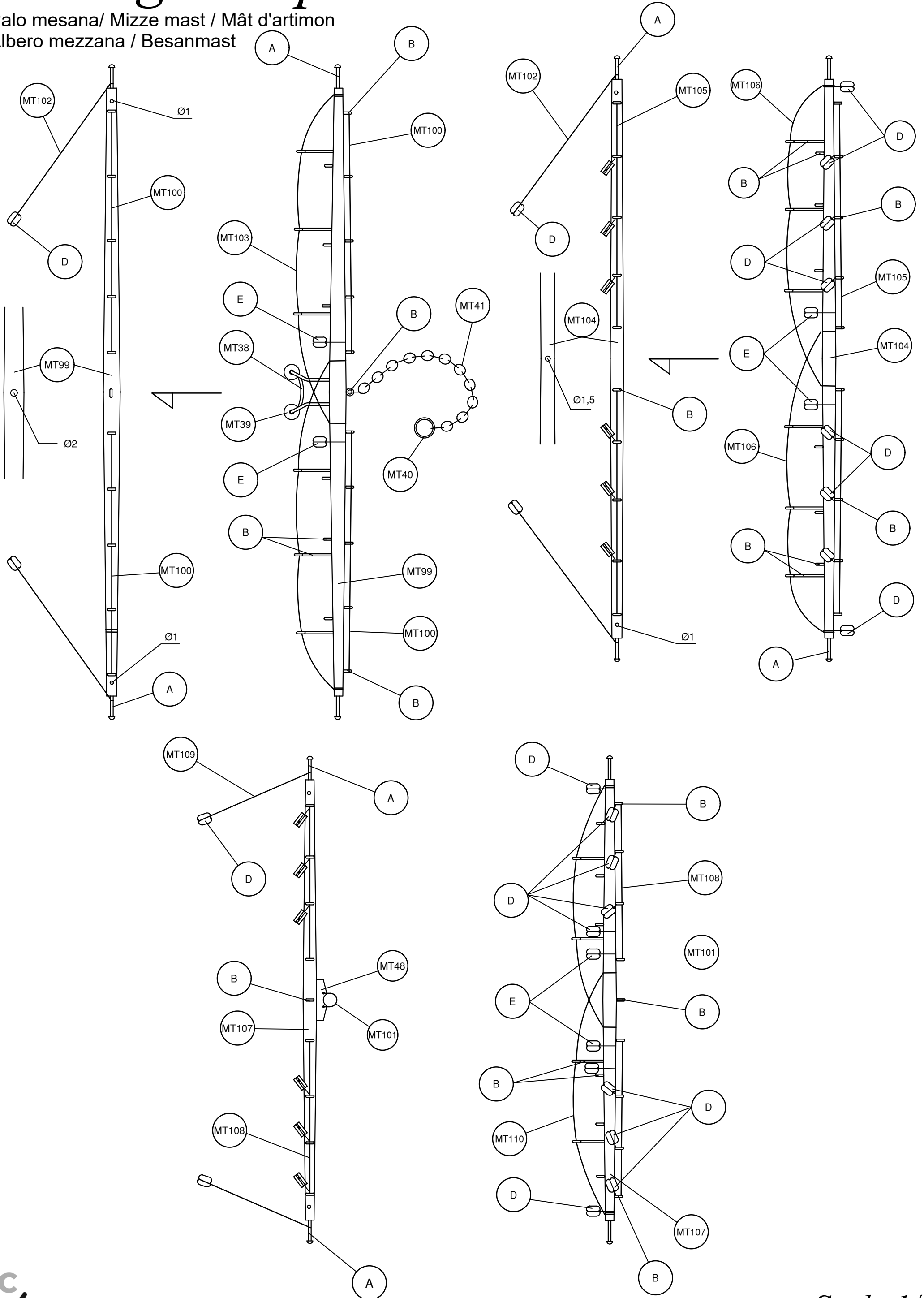

Amerigo Vespucci

Palo mesana/ Mizze mast / Mât d'artimon
Albero mezzana / Besanmast

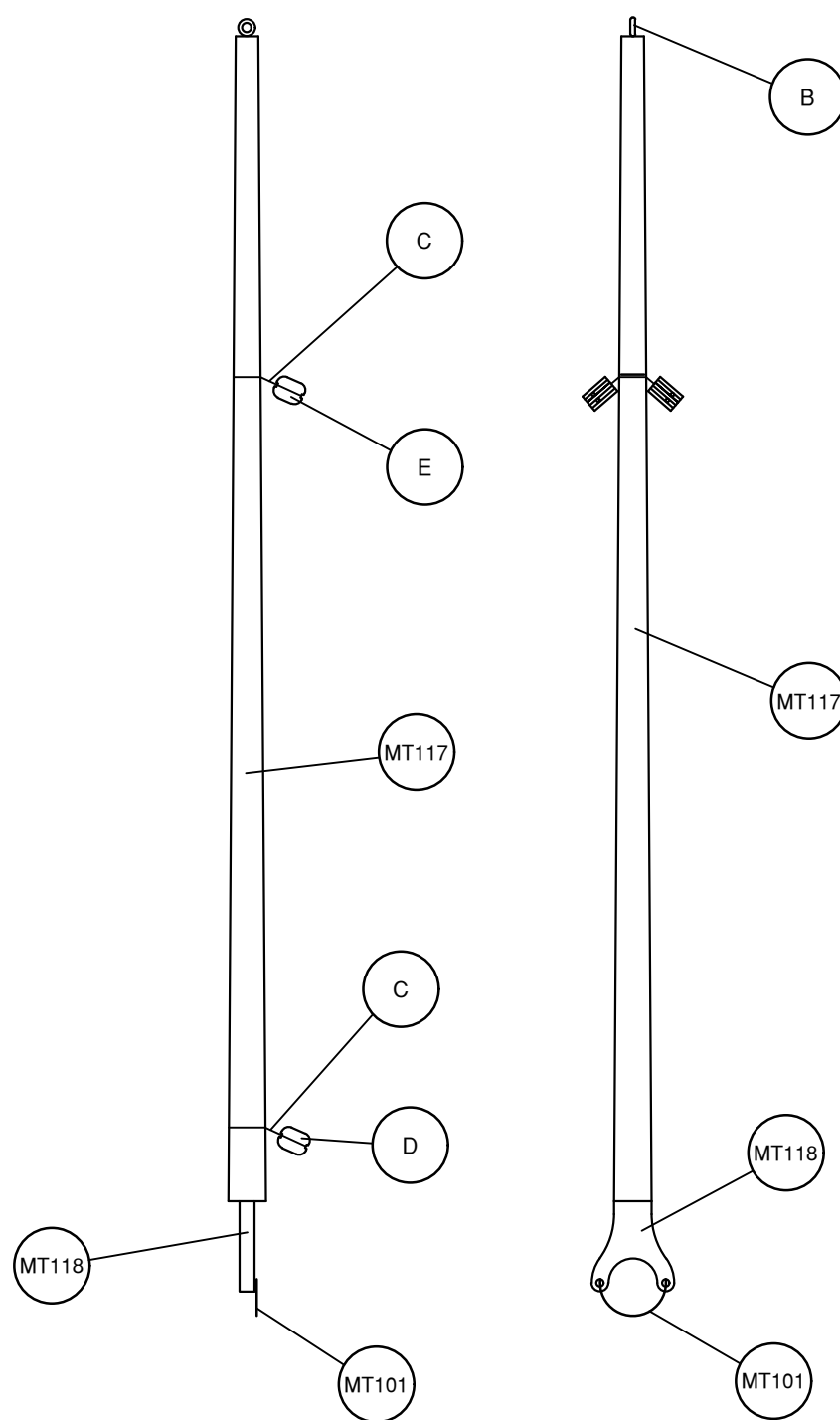
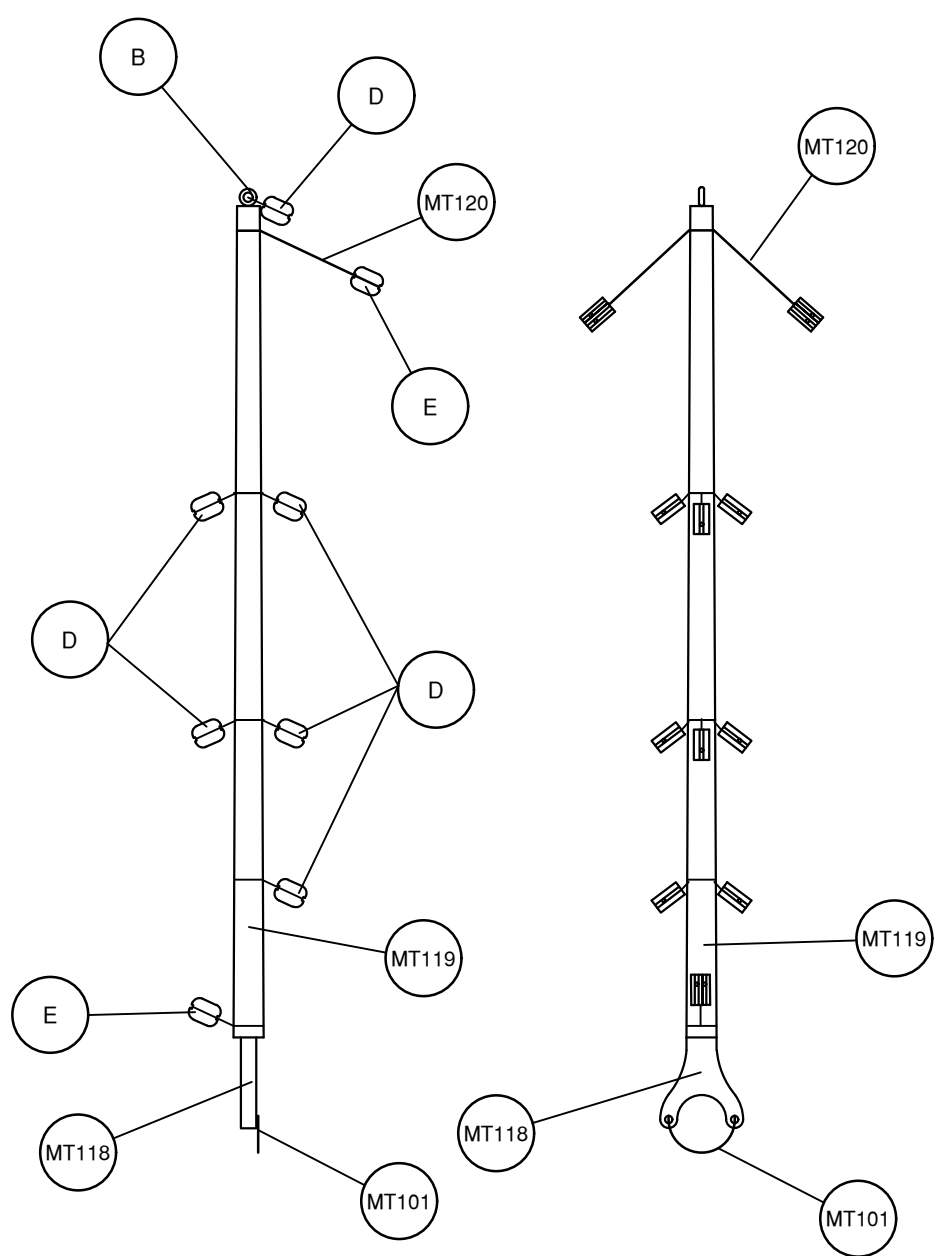
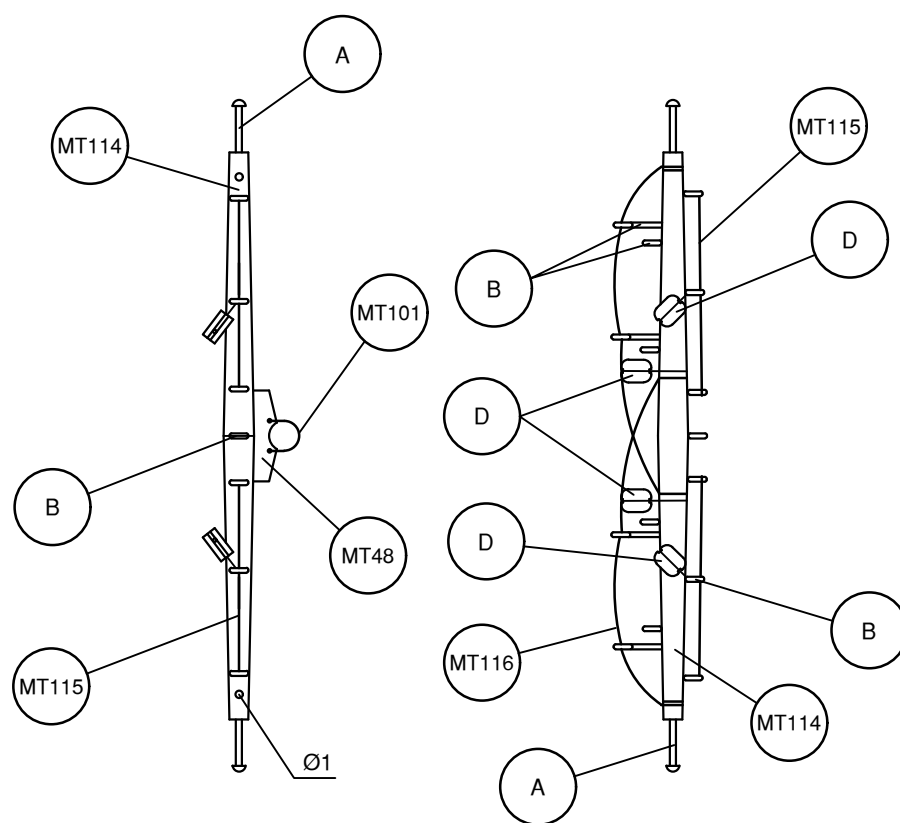
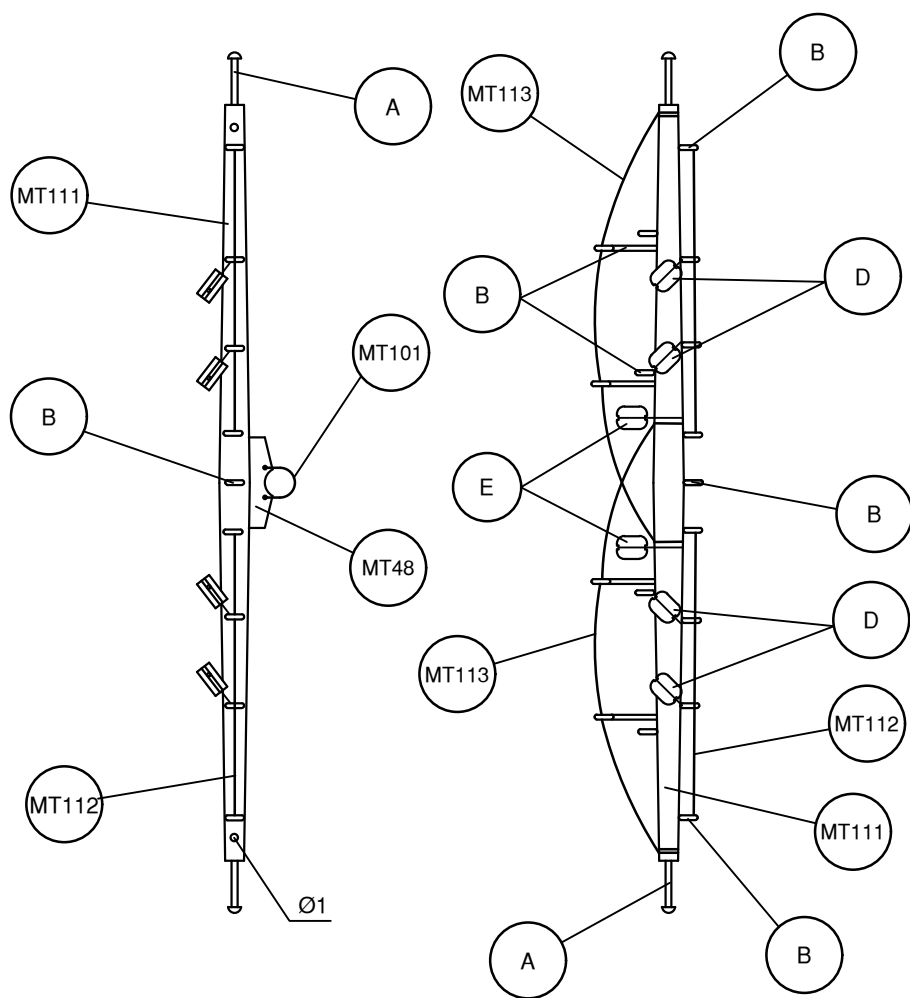

Amerigo Vespucci

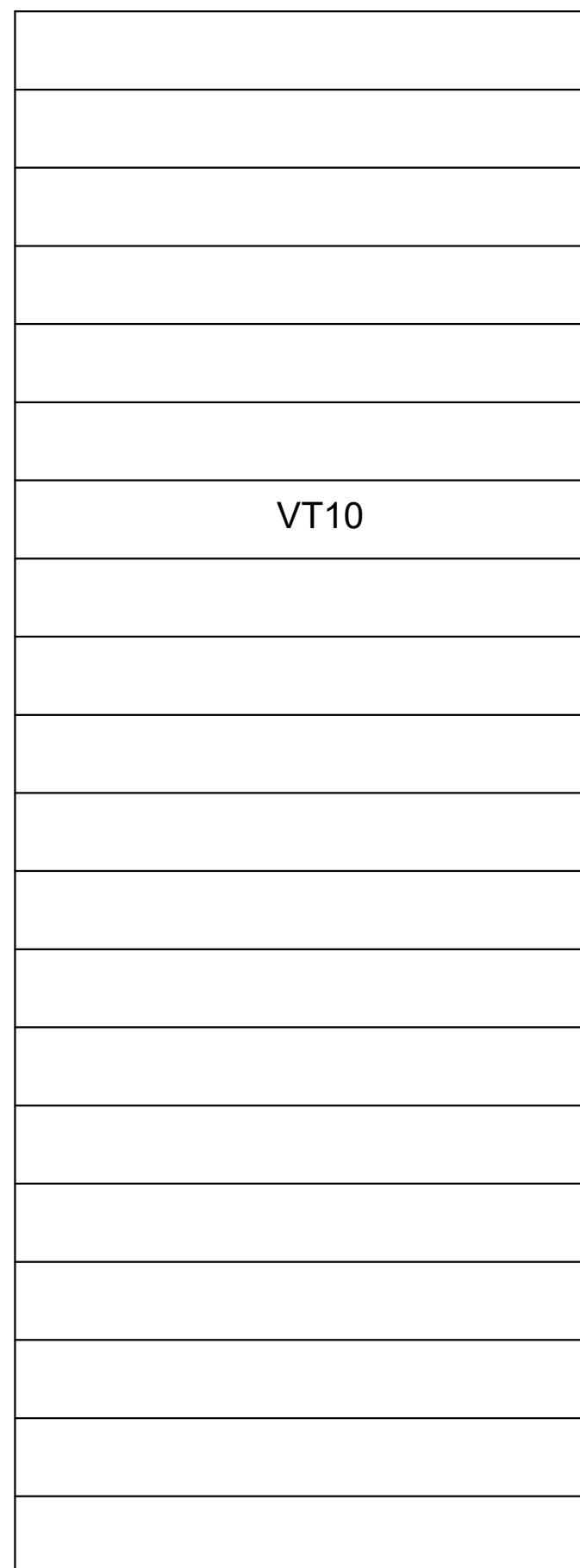
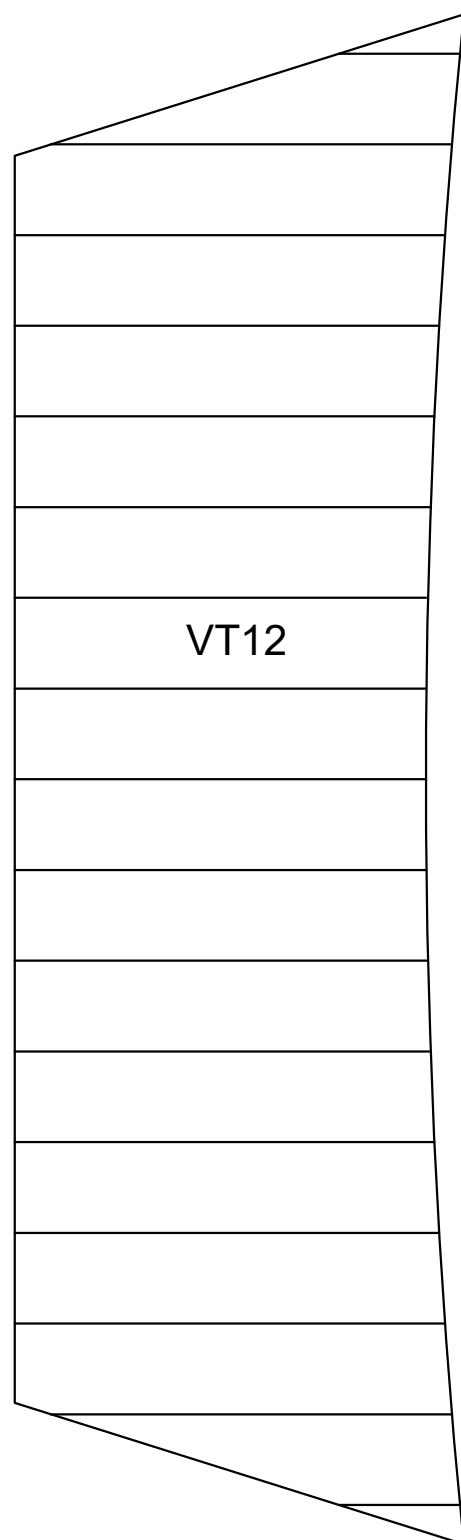
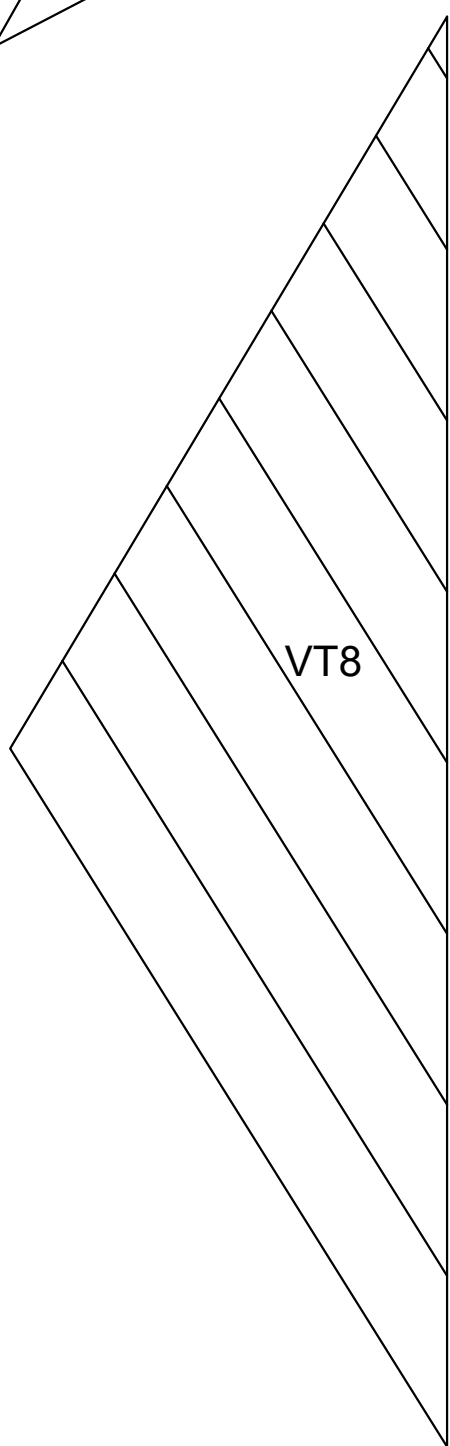
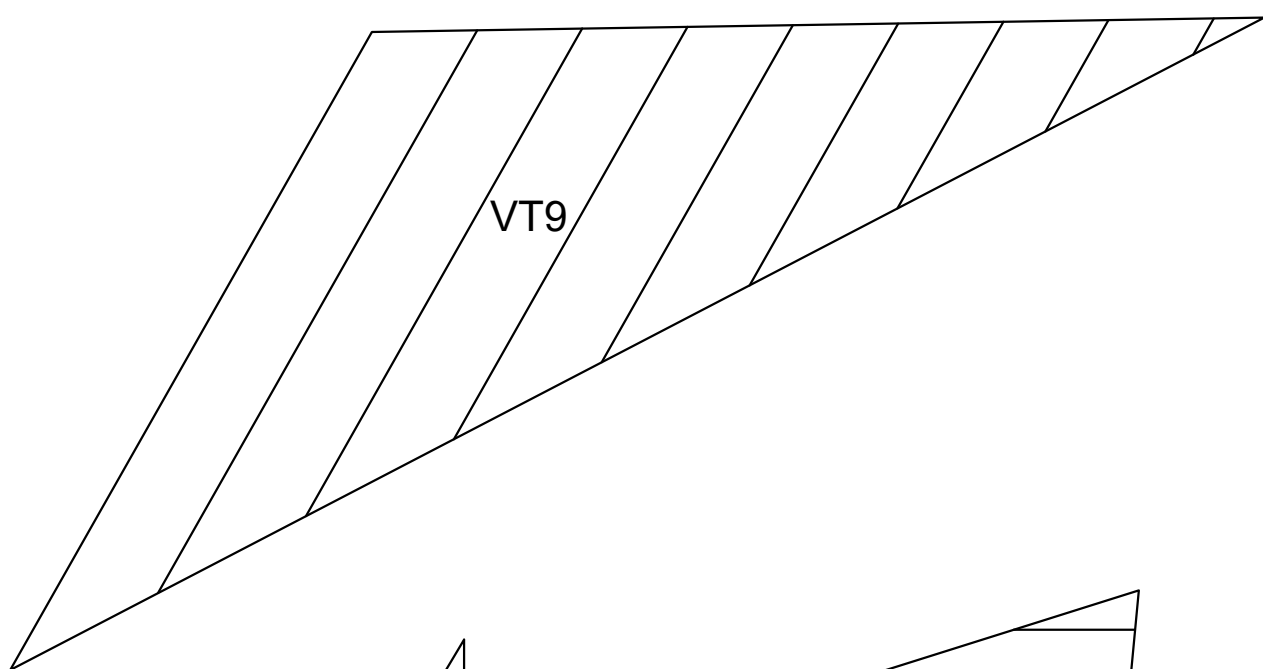
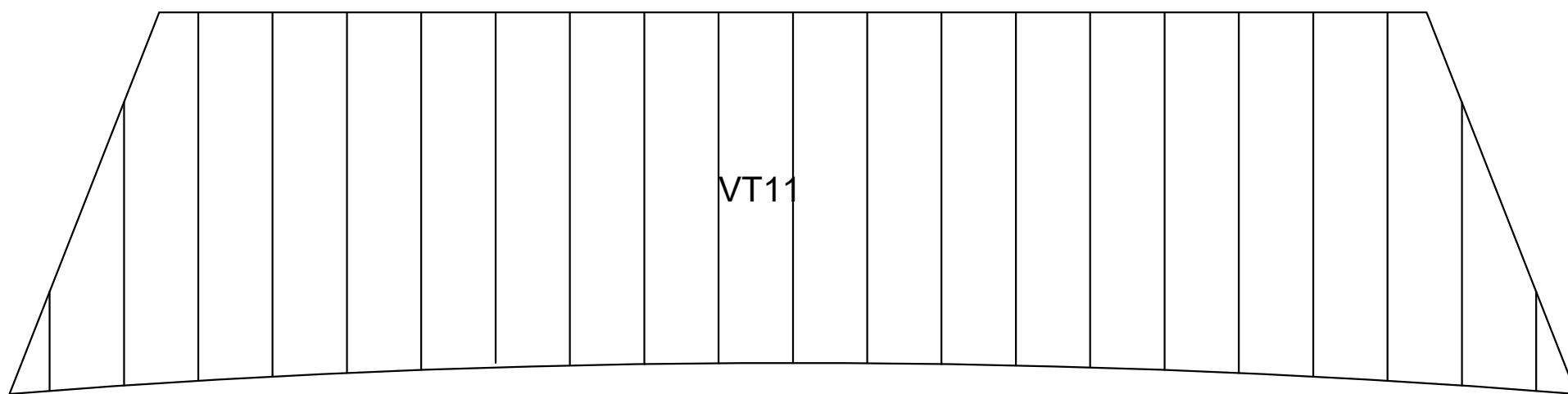

Amerigo Vespucci

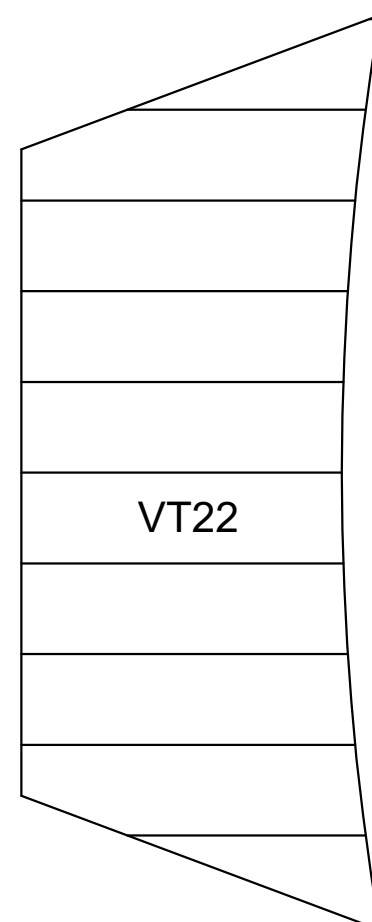
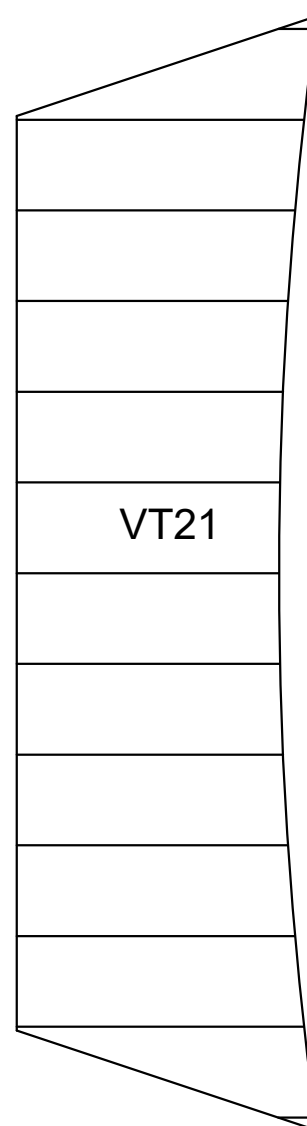
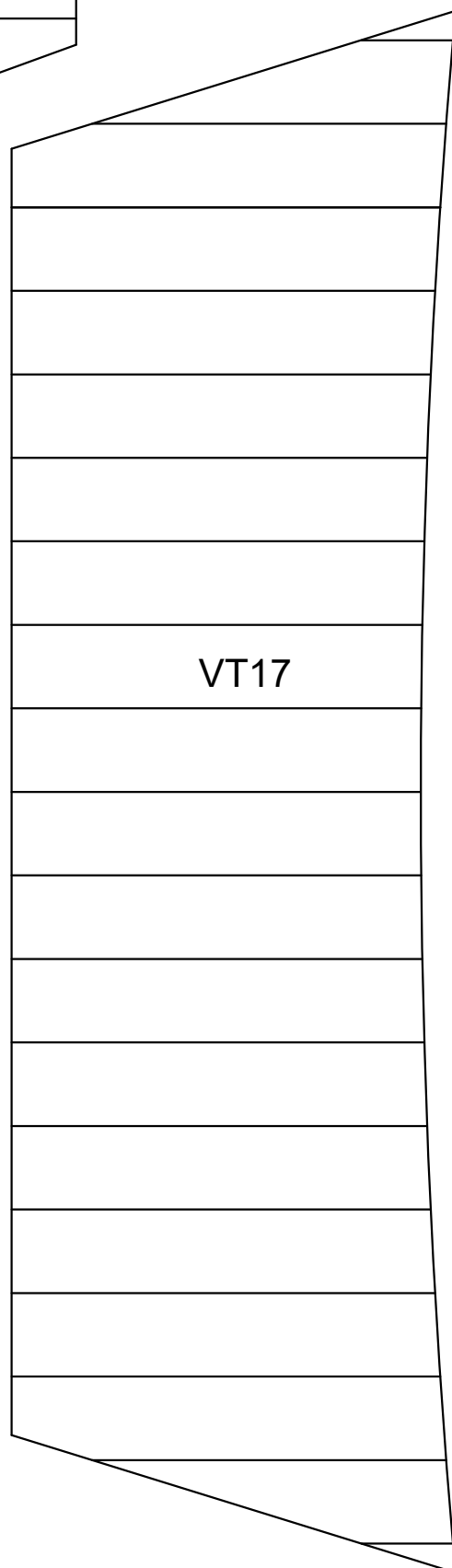
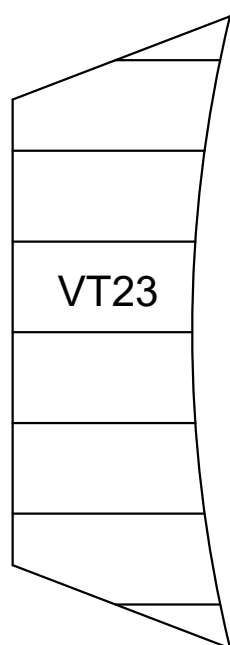
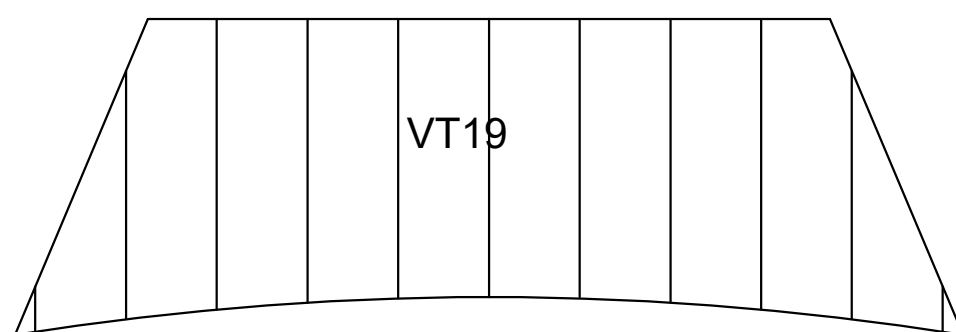
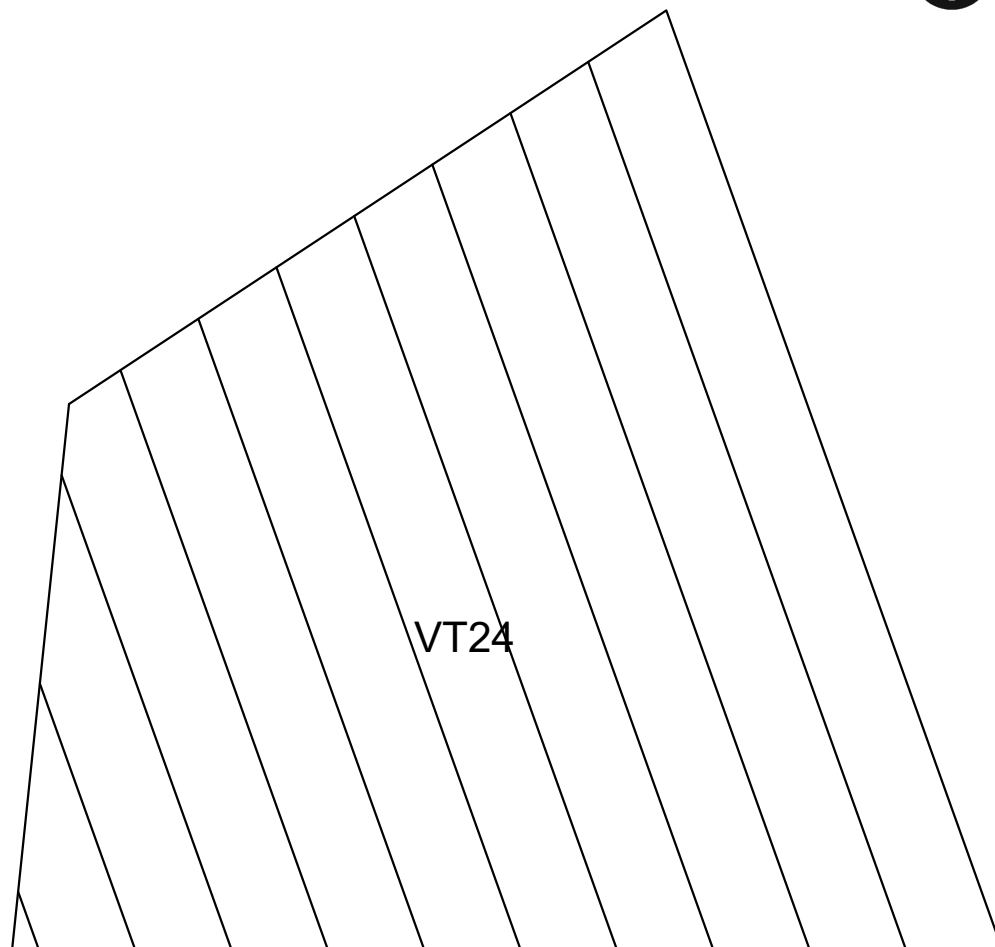
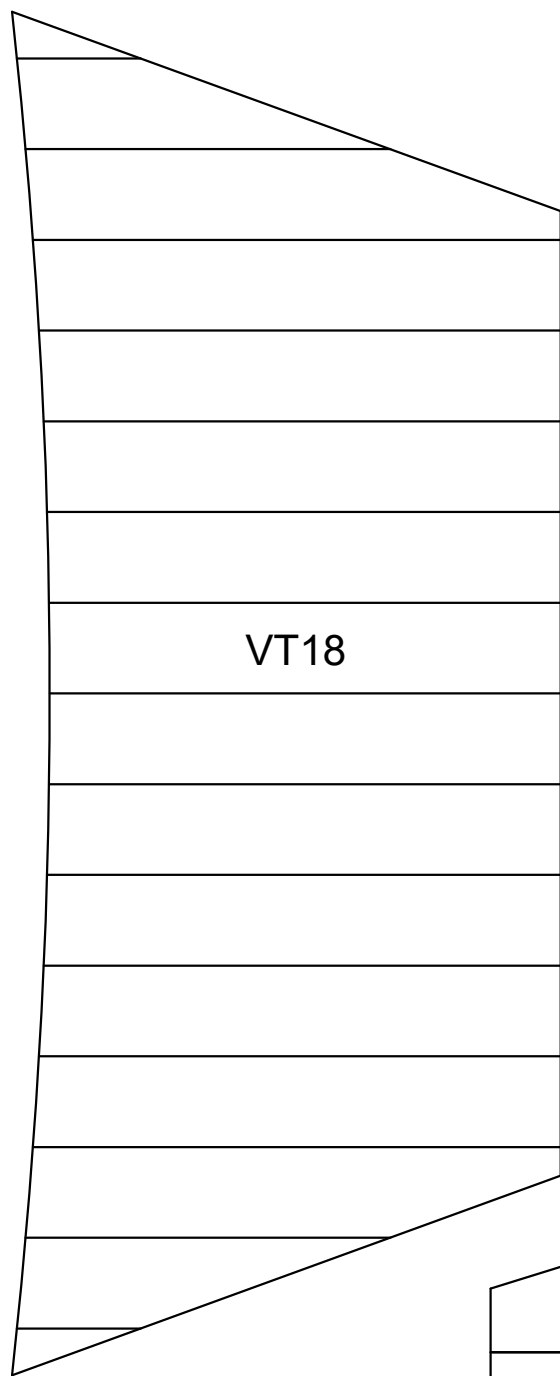

Amerigo Vespucci

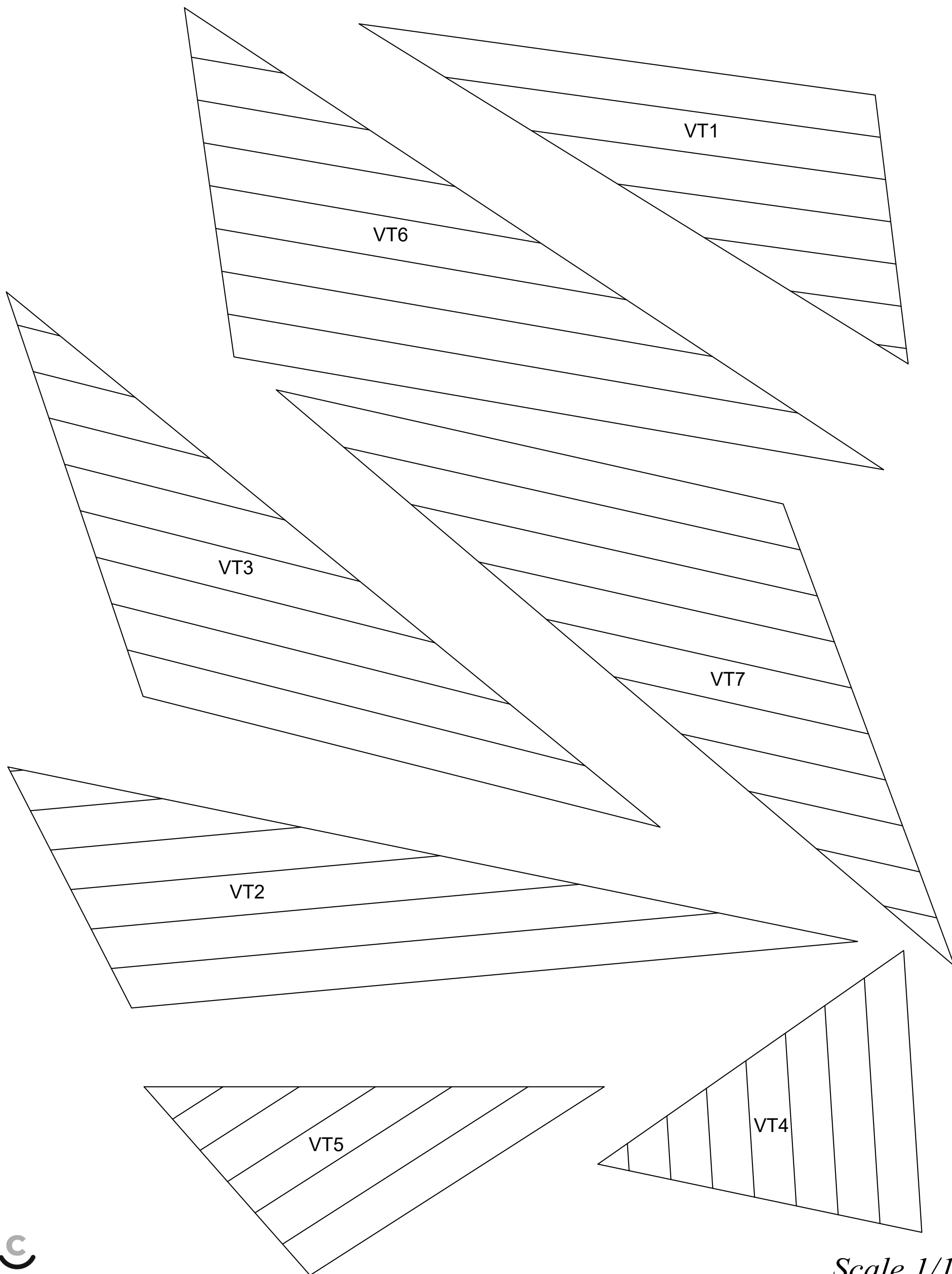

Amerigo Vespucci

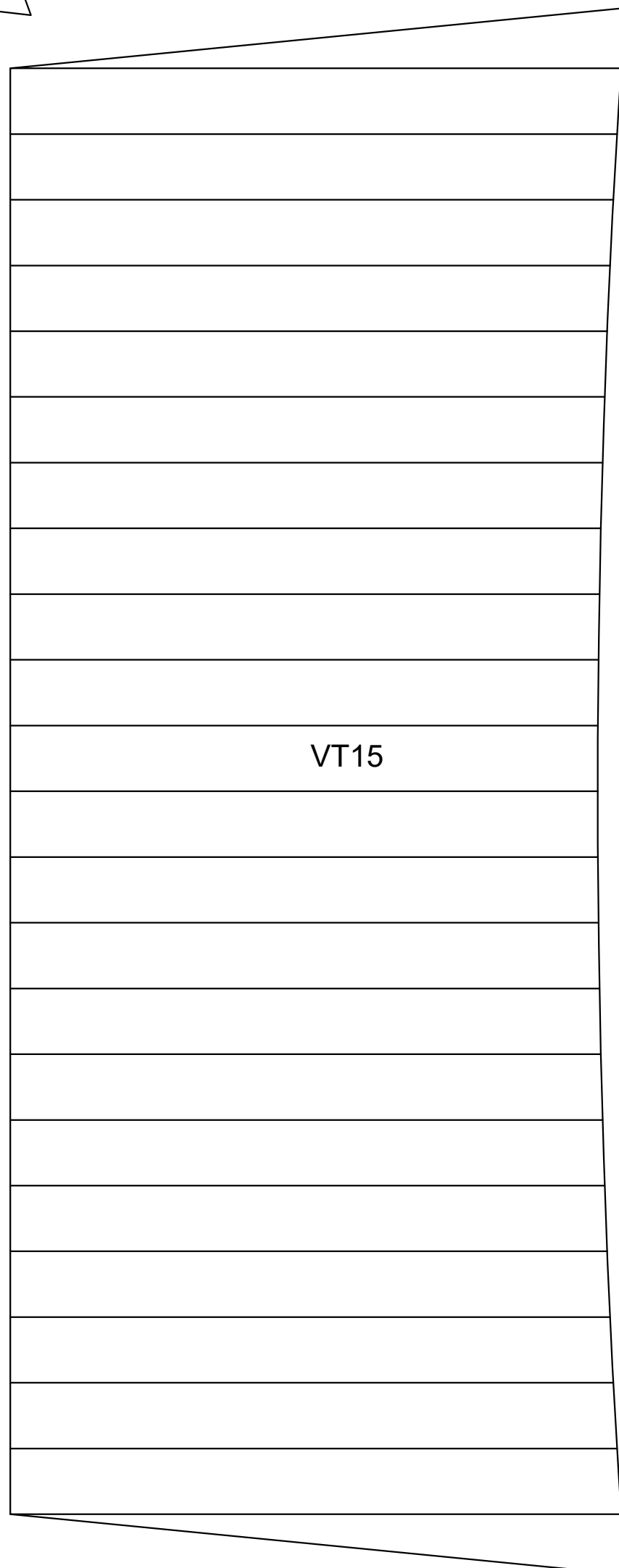
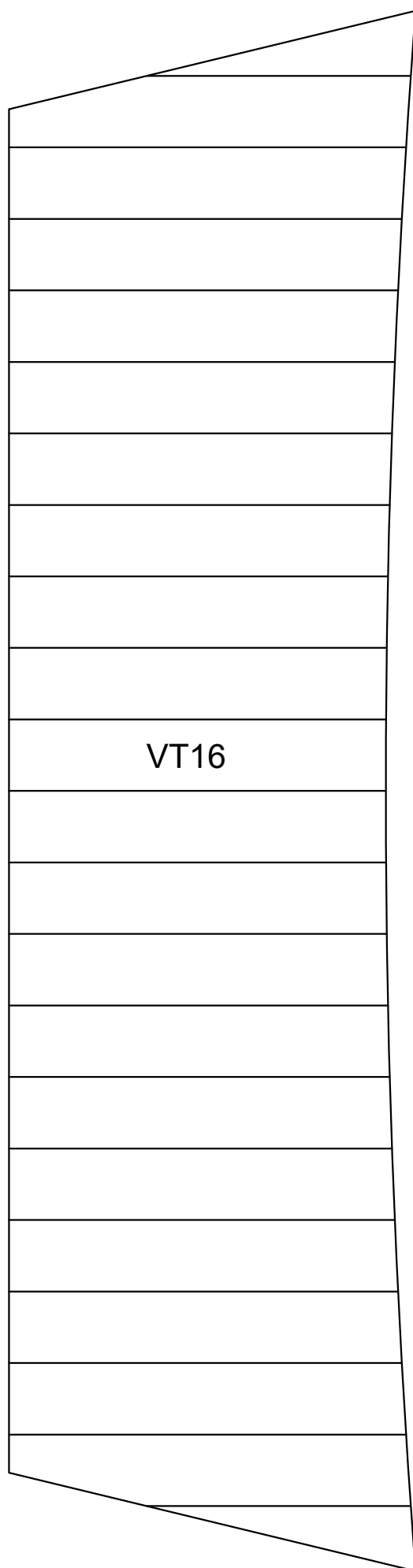
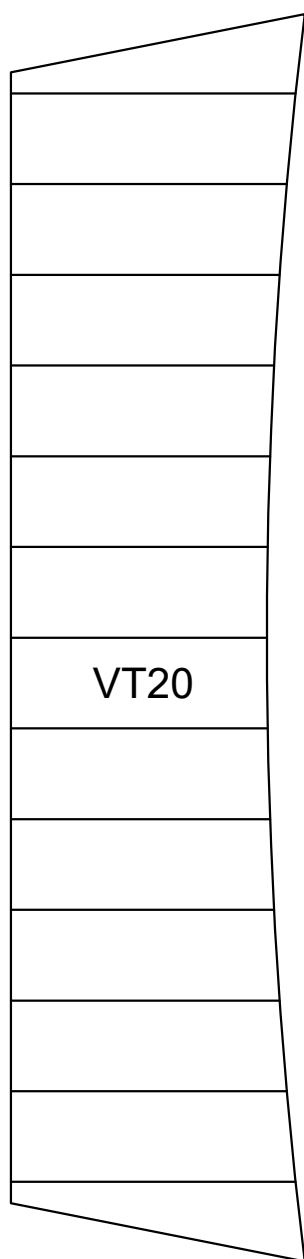
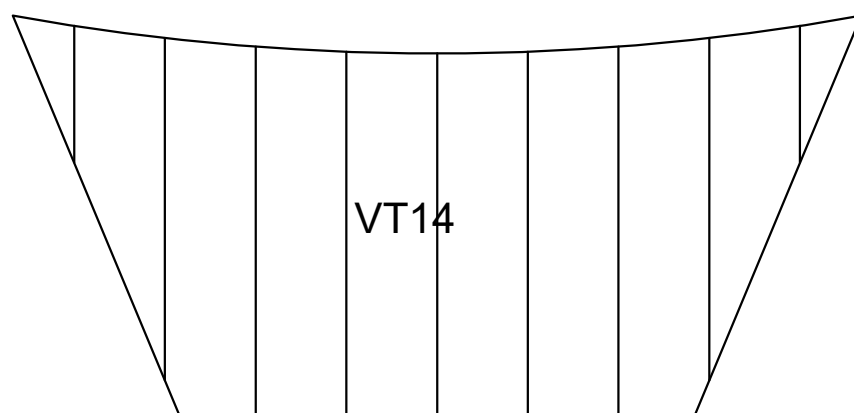
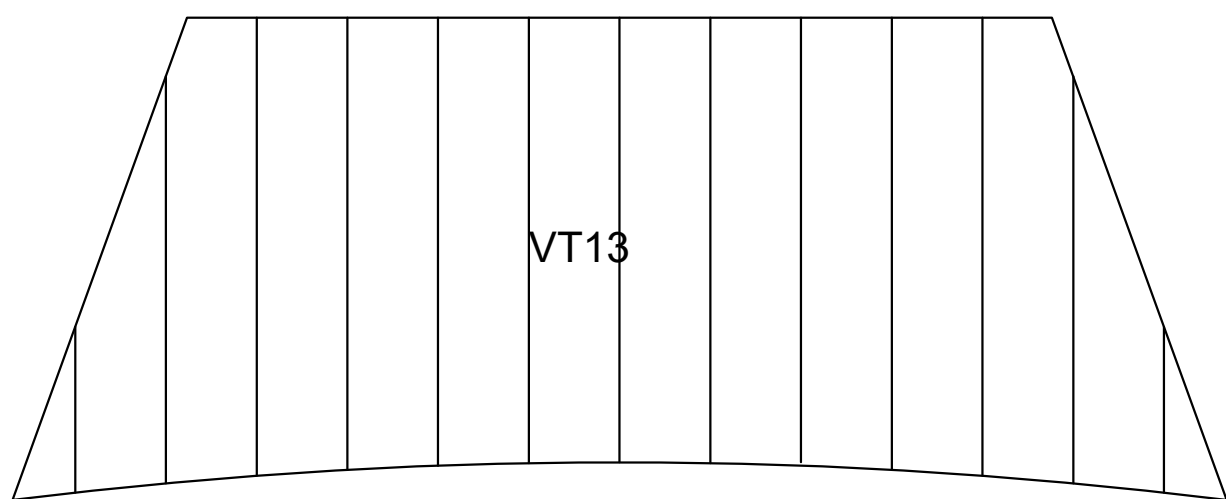

Amerigo Vespucci

OCCRE

(A)

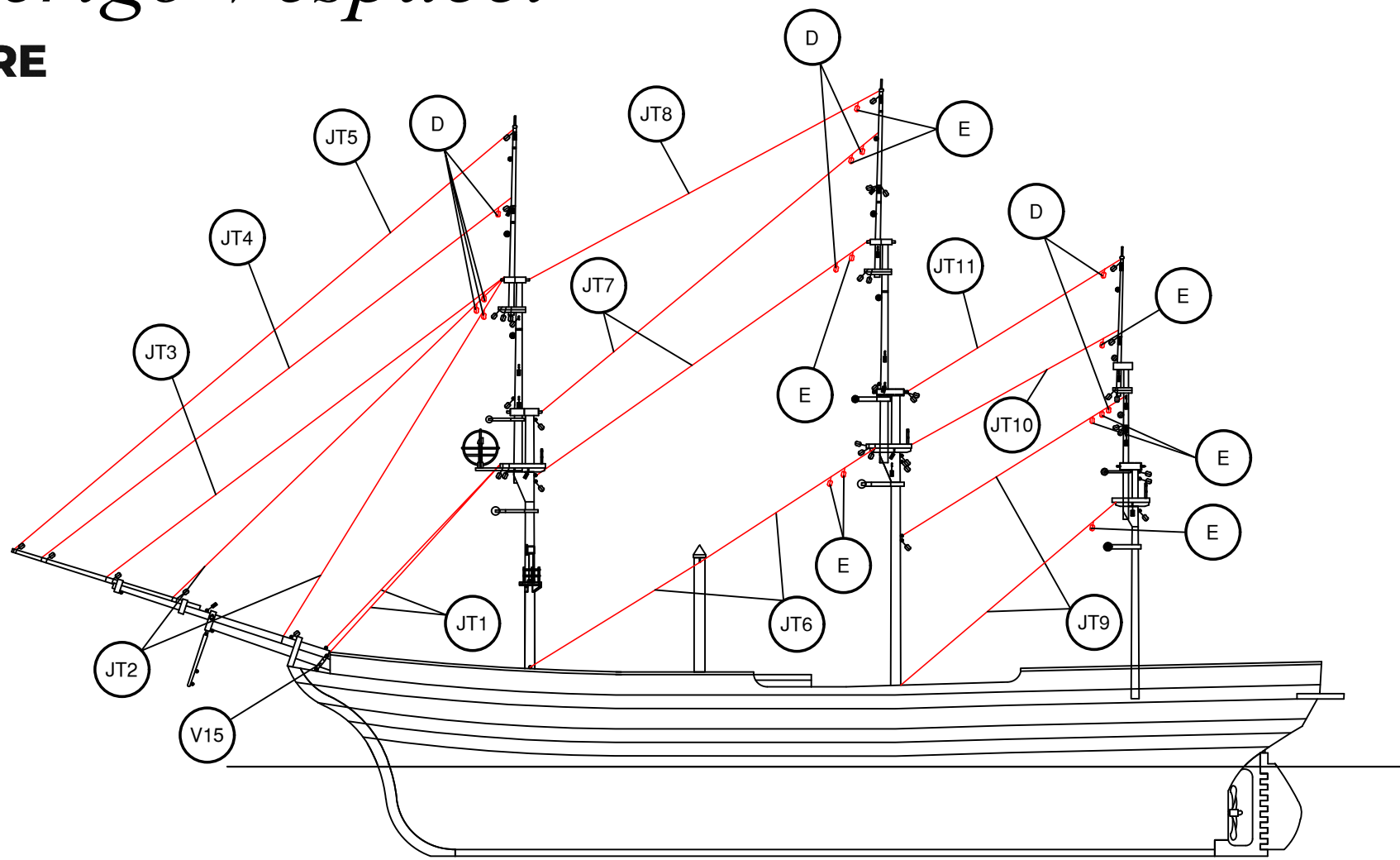

JT1	∅0,80x350	Hilo marrón / Brown thread / Fil brun /braunes Baumwollfaden / Filo marrone	JT8	∅0,80x400	Hilo marrón / Brown thread / Fil brun /braunes Baumwollfaden / Filo marrone
JT2	∅0,80x500	Hilo marrón / Brown thread / Fil brun /braunes Baumwollfaden / Filo marrone	JT9	∅0,80x300	Hilo marrón / Brown thread / Fil brun /braunes Baumwollfaden / Filo marrone
JT3	∅0,80x525	Hilo marrón / Brown thread / Fil brun /braunes Baumwollfaden / Filo marrone	JT10	∅0,80x310	Hilo marrón / Brown thread / Fil brun /braunes Baumwollfaden / Filo marrone
JT4	∅0,80x575	Hilo marrón / Brown thread / Fil brun /braunes Baumwollfaden / Filo marrone	JT11	∅0,80x320	Hilo marrón / Brown thread / Fil brun /braunes Baumwollfaden / Filo marrone
JT5	∅0,80x590	Hilo marrón / Brown thread / Fil brun /braunes Baumwollfaden / Filo marrone	D	4	Madera / Wood / Bois / Holz / Legno
JT6	∅0,80x400	Hilo marrón / Brown thread / Fil brun /braunes Baumwollfaden / Filo marrone	E	4	Madera / Wood / Bois / Holz / Legno
JT7	∅0,80x430	Hilo marrón / Brown thread / Fil brun /braunes Baumwollfaden / Filo marrone	V15	Preformado / Prefomed/ Préformé / Vorgeformt / Preformato	Metal / Metal / Metal / Metall / Metallo

(B)

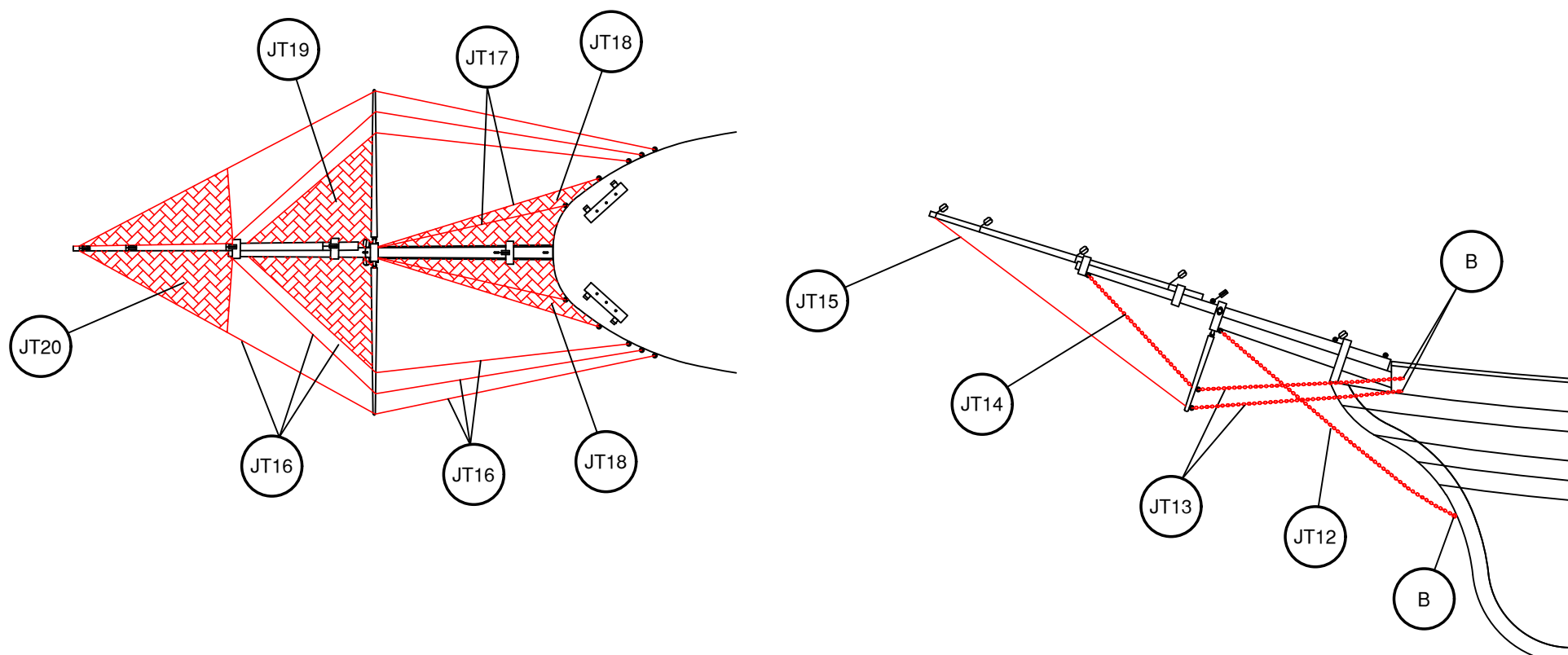

JT12	1x150	Latón / Brass / Latón / Messing / Ottone	JT17	∅0,80x125	Hilo marrón / Brown thread / Fil brun /braunes Baumwollfaden / Filo marrone
JT13	1x120	Latón / Brass / Latón / Messing / Ottone	JT18	Preformado / Prefomed/ Préformé / Vorgeformt / Preformato	Composite / Composite / Composite / Composite / Composite
JT14	1x90	Latón / Brass / Latón / Messing / Ottone	JT19	Preformado / Prefomed/ Préformé / Vorgeformt / Preformato	Composite / Composite / Composite / Composite / Composite
JT15	∅0,80x250	Hilo marrón / Brown thread / Fil brun /braunes Baumwollfaden / Filo marrone	JT20	Preformado / Prefomed/ Préformé / Vorgeformt / Preformato	Composite / Composite / Composite / Composite / Composite
JT16	∅0,80x675	Hilo marrón / Brown thread / Fil brun /braunes Baumwollfaden / Filo marrone			

Amerigo Vespucci

OCCRE

(C)

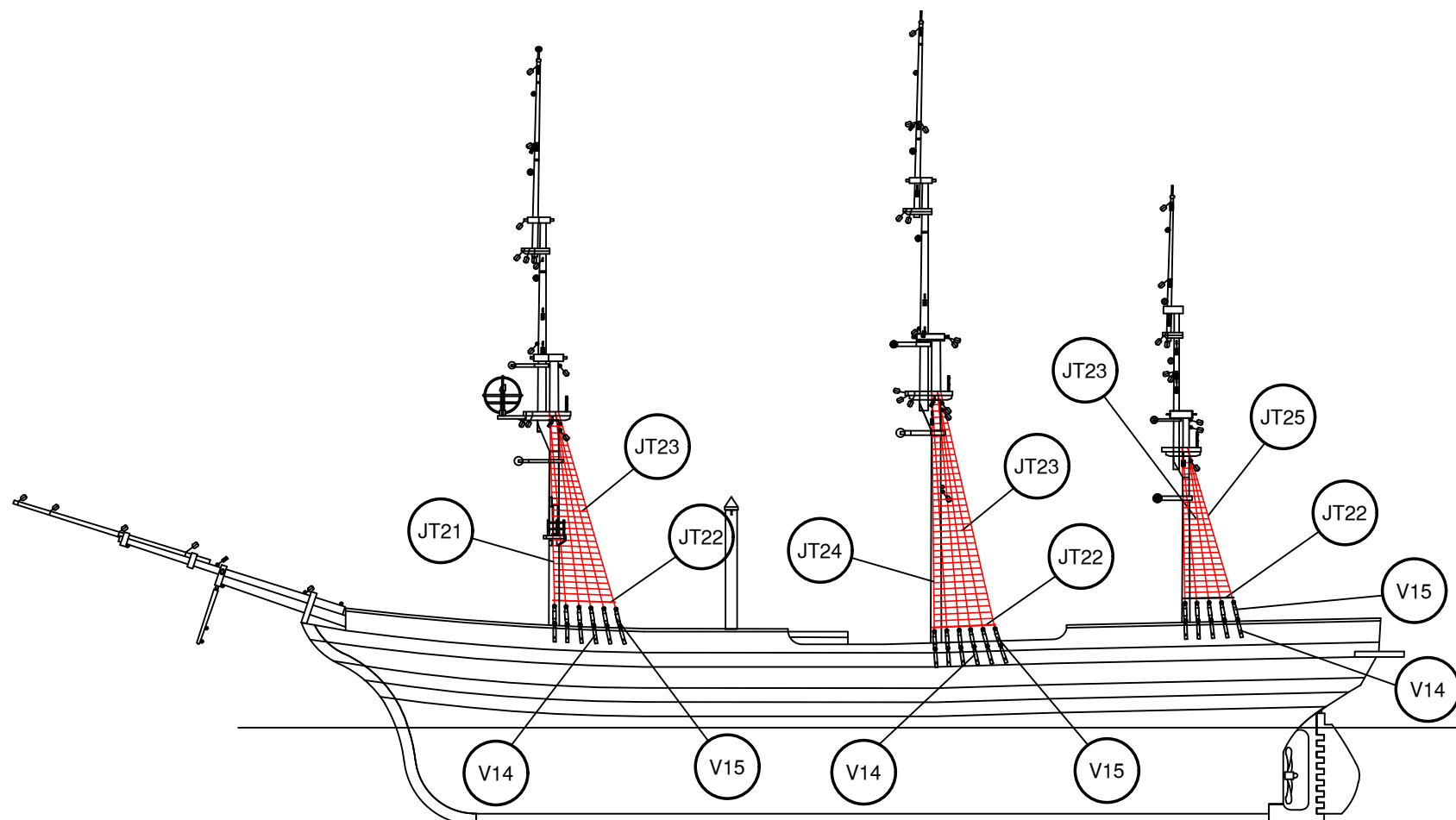

JT21	ø0,80x580	Hilo marrón / Brown thread / Fil brun /braunes Baumwollfaden / Filo marrone	JT25	ø0,80x560	Hilo marrón / Brown thread / Fil brun /braunes Baumwollfaden / Filo marrone
JT22	ø1x45	Latón / Brass / Latón / Messing / Ottone	V14	Preformado / Preformed/ Préformé / Vorgeformt / Preformato	Latón / Brass / Latón / Messing / Ottone
JT23	ø0,15x100	Hilo crudo / Raw thread / Fil brut / Rohes Baumwollfaden / Filo crudo	V15	Preformado / Preformed/ Préformé / Vorgeformt / Preformato	Metal / Metal / Metal / Metall / Metallo
JT24	ø0,80x620	Hilo marrón / Brown thread / Fil brun /braunes Baumwollfaden / Filo marrone			

(D)

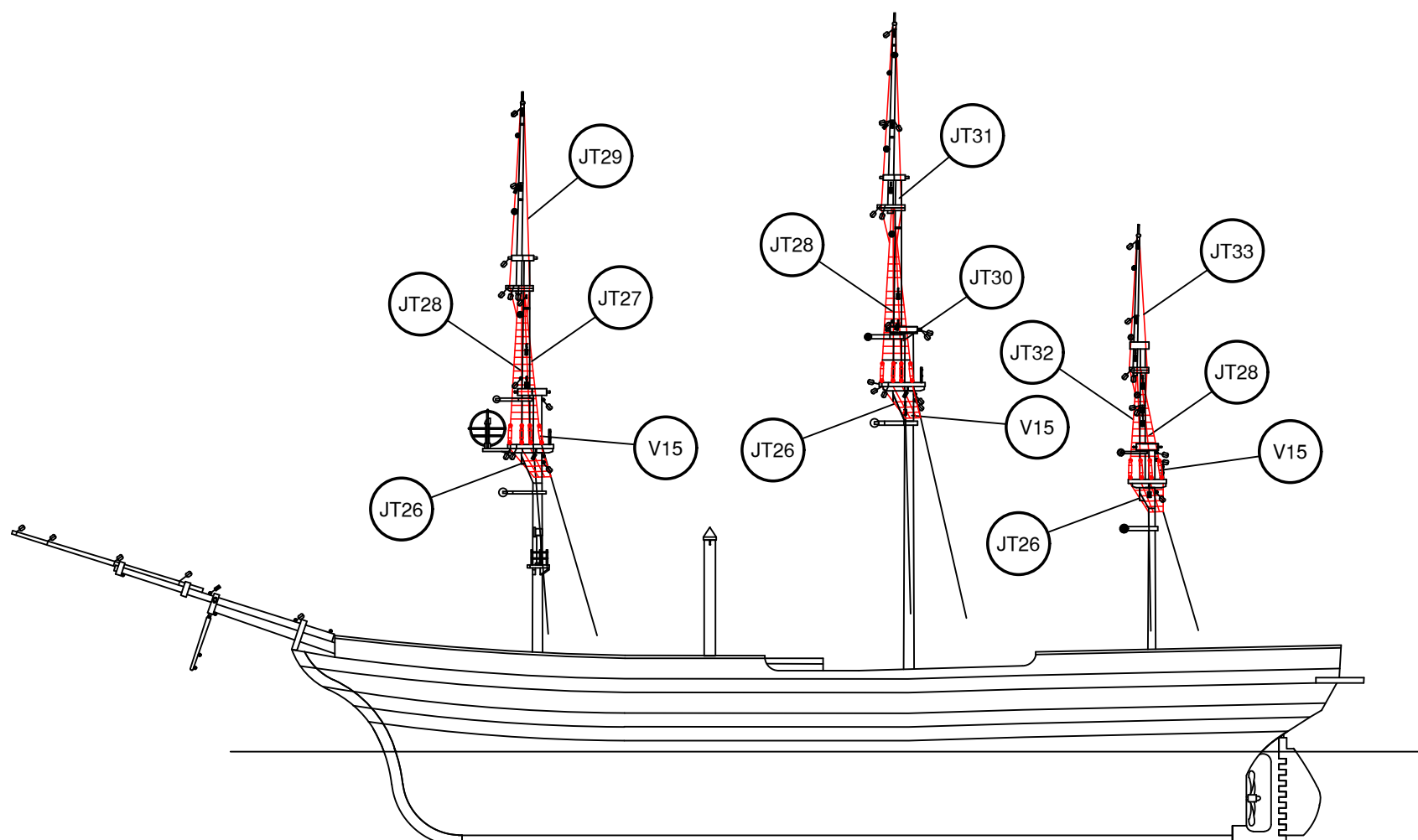

JT26	ø0,50x150	Hilo marrón / Brown thread / Fil brun /braunes Baumwollfaden / Filo marrone	JT31	ø0,50x400	Hilo marrón / Brown thread / Fil brun /braunes Baumwollfaden / Filo marrone
JT27	ø0,50x300	Hilo marrón / Brown thread / Fil brun /braunes Baumwollfaden / Filo marrone	JT32	ø0,50x300	Hilo marrón / Brown thread / Fil brun /braunes Baumwollfaden / Filo marrone
JT28	ø0,15x100	Hilo crudo / Raw thread / Fil brut / Rohes Baumwollfaden / Filo crudo	JT33	ø0,50x300	Hilo marrón / Brown thread / Fil brun /braunes Baumwollfaden / Filo marrone
JT29	ø0,50x400	Hilo marrón / Brown thread / Fil brun /braunes Baumwollfaden / Filo marrone	V15	Preformado / Preformed/ Préformé / Vorgeformt / Preformato	Metal / Metal / Metal / Metall / Metallo
JT30	ø0,50x350	Hilo marrón / Brown thread / Fil brun /braunes Baumwollfaden / Filo marrone			

Amerigo Vespucci

OCCRE

Aparejo de velas / Sail rig / Gréement
Segel takelage / Sartieme da vela

E

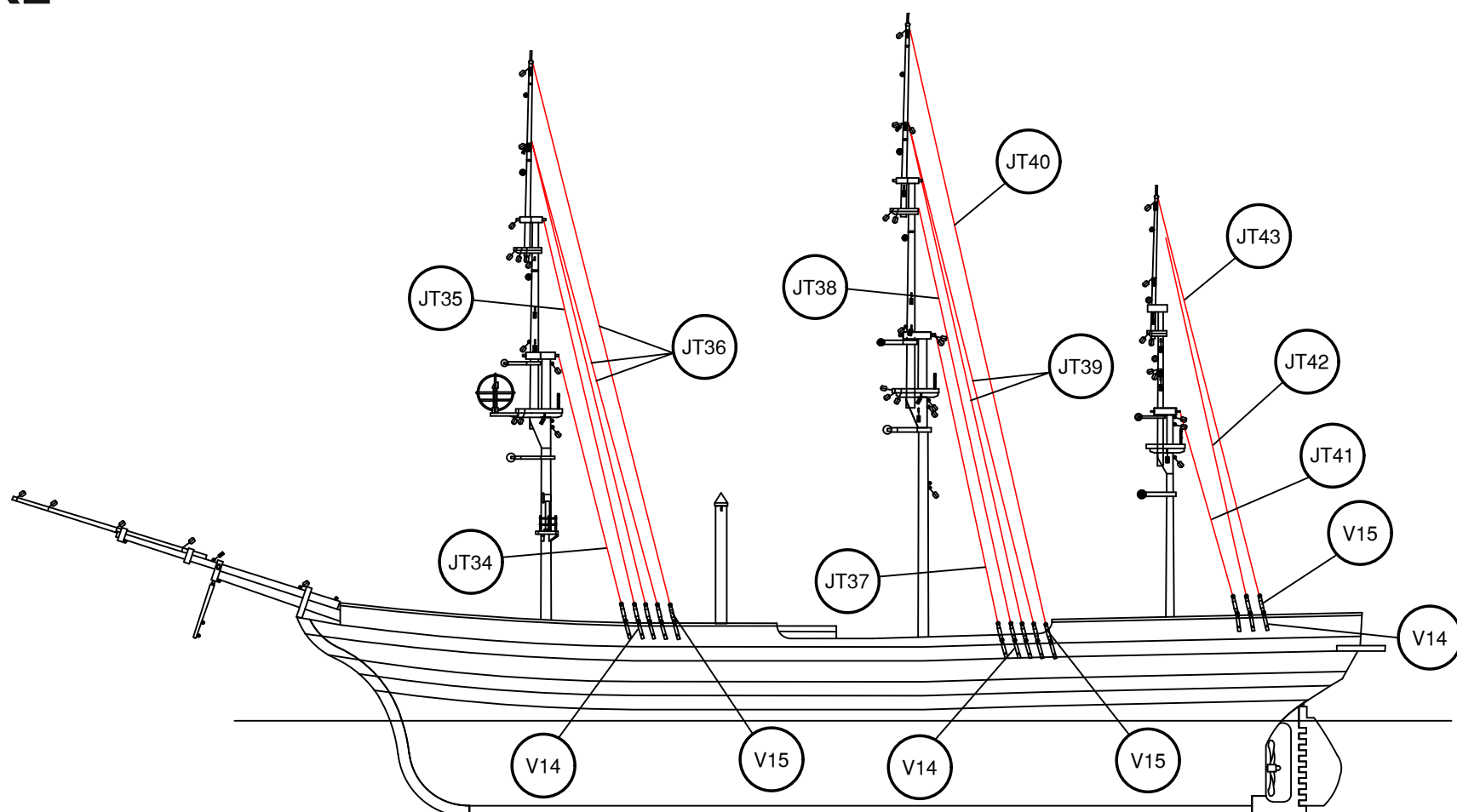

JT34	ø0,50x300	Hilo marrón / Brown thread / Fil brun /braunes Baumwollfaden / Filo marrone	JT40	ø0,50x600	Hilo marrón / Brown thread / Fil brun /braunes Baumwollfaden / Filo marrone
JT35	ø0,50x400	Hilo marrón / Brown thread / Fil brun /braunes Baumwollfaden / Filo marrone	JT41	ø0,50x375	Hilo marrón / Brown thread / Fil brun /braunes Baumwollfaden / Filo marrone
JT36	ø0,50x550	Hilo marrón / Brown thread / Fil brun /braunes Baumwollfaden / Filo marrone	JT42	ø0,50x400	Hilo marrón / Brown thread / Fil brun /braunes Baumwollfaden / Filo marrone
JT37	ø0,50x300	Hilo marrón / Brown thread / Fil brun /braunes Baumwollfaden / Filo marrone	JT43	ø0,50x500	Hilo marrón / Brown thread / Fil brun /braunes Baumwollfaden / Filo marrone
JT38	ø0,50x350	Hilo marrón / Brown thread / Fil brun /braunes Baumwollfaden / Filo marrone	V14	Preformado / Preformed/ Préformé / Vorgeformt / Preformato	Latón / Brass / Latón / Messing / Ottone
JT39	ø0,50x450	Hilo marrón / Brown thread / Fil brun /braunes Baumwollfaden / Filo marrone	V15	Preformado / Preformed/ Préformé / Vorgeformt / Preformato	Metal / Metal / Metal / Metall / Metallo

F

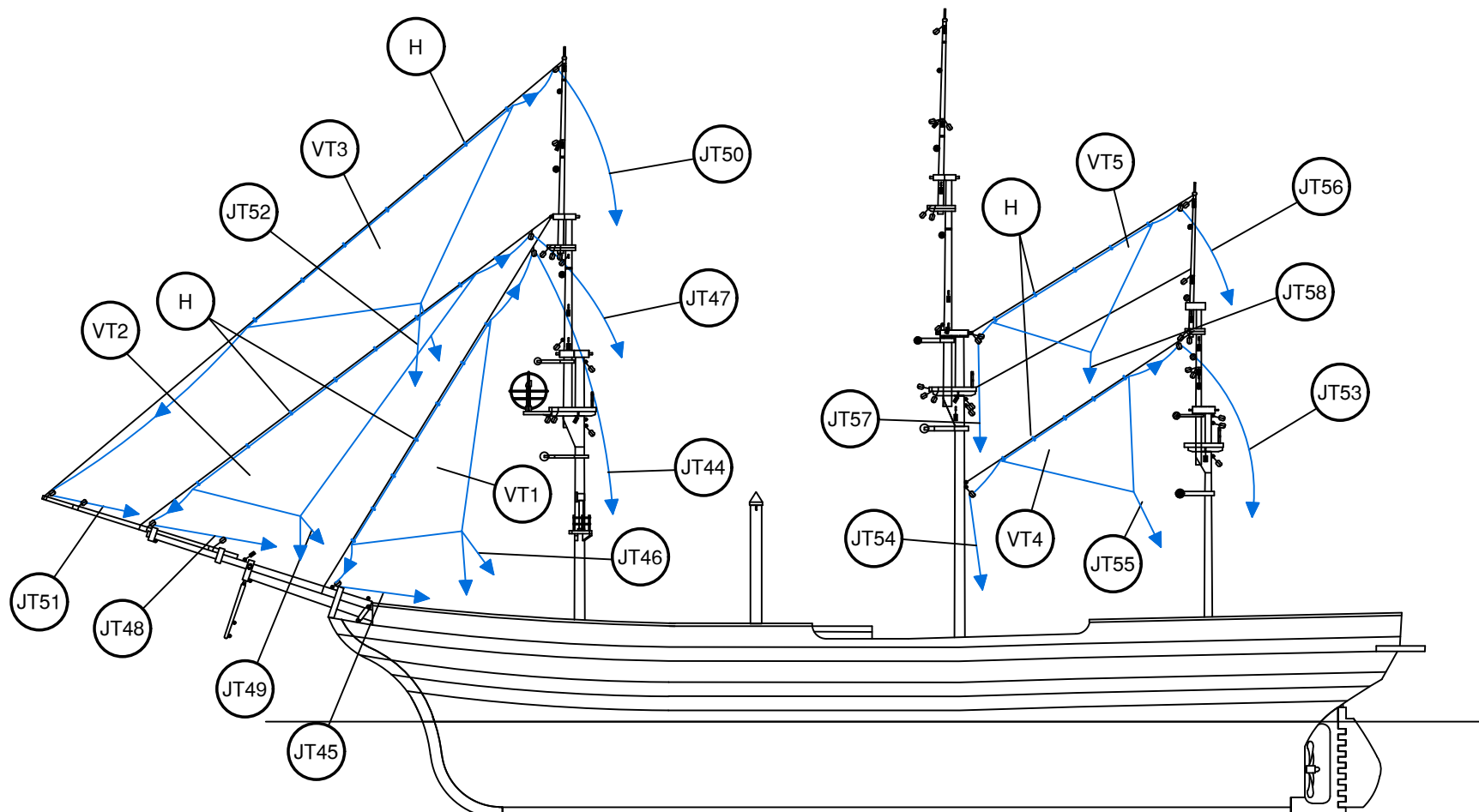

VT1	Preformado / Preformed/ Préformé / Vorgeformt / Preformato	Tela / Cloth / Éttoffe / Stoff / Tela	JT49	ø0,15x300	Hilo crudo / Raw thread / Fil brut / Rohes Baumwollfaden / Filo crudo	JT54	ø0,15x350	Hilo crudo / Raw thread / Fil brut / Rohes Baumwollfaden / Filo crudo
JT44	ø0,15x400	Hilo crudo / Raw thread / Fil brut / Rohes Baumwollfaden / Filo crudo	VT3	Preformado / Preformed/ Préformé / Vorgeformt / Preformato	Tela / Cloth / Éttoffe / Stoff / Tela	JT55	ø0,15x275	Hilo crudo / Raw thread / Fil brut / Rohes Baumwollfaden / Filo crudo
JT45	ø0,15x275	Hilo crudo / Raw thread / Fil brut / Rohes Baumwollfaden / Filo crudo	JT50	ø0,15x700	Hilo crudo / Raw thread / Fil brut / Rohes Baumwollfaden / Filo crudo	VT5	Preformado / Preformed/ Préformé / Vorgeformt / Preformato	Tela / Cloth / Éttoffe / Stoff / Tela
JT46	ø0,15x200	Hilo crudo / Raw thread / Fil brut / Rohes Baumwollfaden / Filo crudo	JT51	ø0,15x600	Hilo crudo / Raw thread / Fil brut / Rohes Baumwollfaden / Filo crudo	JT56	ø0,15x500	Hilo crudo / Raw thread / Fil brut / Rohes Baumwollfaden / Filo crudo
VT2	Preformado / Preformed/ Préformé / Vorgeformt / Preformato	Tela / Cloth / Éttoffe / Stoff / Tela	JT52	ø0,15x350	Hilo crudo / Raw thread / Fil brut / Rohes Baumwollfaden / Filo crudo	JT57	ø0,15x425	Hilo crudo / Raw thread / Fil brut / Rohes Baumwollfaden / Filo crudo
JT47	ø0,15x600	Hilo crudo / Raw thread / Fil brut / Rohes Baumwollfaden / Filo crudo	VT4	Preformado / Preformed/ Préformé / Vorgeformt / Preformato	Tela / Cloth / Éttoffe / Stoff / Tela	JT58	ø0,15x325	Hilo crudo / Raw thread / Fil brut / Rohes Baumwollfaden / Filo crudo
JT48	ø0,15x450	Hilo crudo / Raw thread / Fil brut / Rohes Baumwollfaden / Filo crudo	JT53	ø0,15x450	Hilo crudo / Raw thread / Fil brut / Rohes Baumwollfaden / Filo crudo	H	Preformado / Preformed/ Préformé / Vorgeformt / Preformato	Latón / Brass / Latón / Messing / Ottone

Amerigo Vespucci

OCCRE

Aparejo de velas / Sail rig / Gréement
Segel takelage / Sartiamé da vela

G

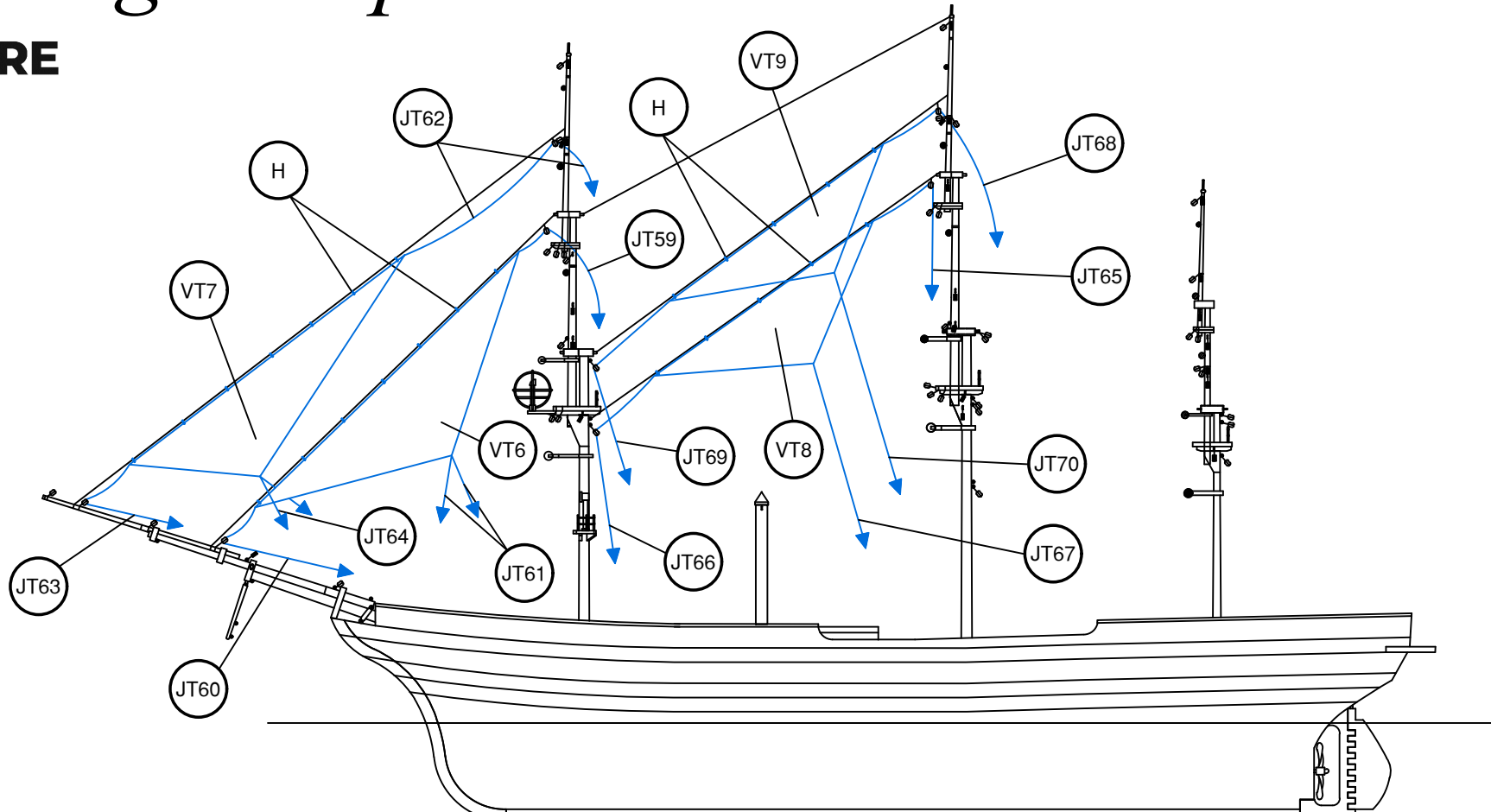

VT6	Preformado / Prefomed/ Préformé / Vorgeformt / Preformato	Tela / Cloth / Étoffe / Stoff / Tela	JT65	ø0,15x680	Hilo crudo / Raw thread / Fil brut / Rohes Baumwollfaden / Filo crudo
JT59	ø0,15x400	Hilo crudo / Raw thread / Fil brut / Rohes Baumwollfaden / Filo crudo	JT66	ø0,15x350	Hilo crudo / Raw thread / Fil brut / Rohes Baumwollfaden / Filo crudo
JT60	ø0,15x300	Hilo crudo / Raw thread / Fil brut / Rohes Baumwollfaden / Filo crudo	JT67	ø0,15x350	Hilo crudo / Raw thread / Fil brut / Rohes Baumwollfaden / Filo crudo
JT61	ø0,15x250	Hilo crudo / Raw thread / Fil brut / Rohes Baumwollfaden / Filo crudo	VT9	Preformado / Prefomed/ Préformé / Vorgeformt / Preformato	Tela / Cloth / Étoffe / Stoff / Tela
VT7	Preformado / Prefomed/ Préformé / Vorgeformt / Preformato	Tela / Cloth / Étoffe / Stoff / Tela	JT68	ø0,15x700	Hilo crudo / Raw thread / Fil brut / Rohes Baumwollfaden / Filo crudo
JT62	ø0,15x700	Hilo crudo / Raw thread / Fil brut / Rohes Baumwollfaden / Filo crudo	JT69	ø0,15x375	Hilo crudo / Raw thread / Fil brut / Rohes Baumwollfaden / Filo crudo
JT63	ø0,15x400	Hilo crudo / Raw thread / Fil brut / Rohes Baumwollfaden / Filo crudo	JT70	ø0,15x350	Hilo crudo / Raw thread / Fil brut / Rohes Baumwollfaden / Filo crudo
JT64	ø0,15x350	Hilo crudo / Raw thread / Fil brut / Rohes Baumwollfaden / Filo crudo	H	Preformado / Prefomed/ Préformé / Vorgeformt / Preformato	Latón / Brass / Latón / Messing / Ottone
VT8	Preformado / Prefomed/ Préformé / Vorgeformt / Preformato	Tela / Cloth / Étoffe / Stoff / Tela			

H

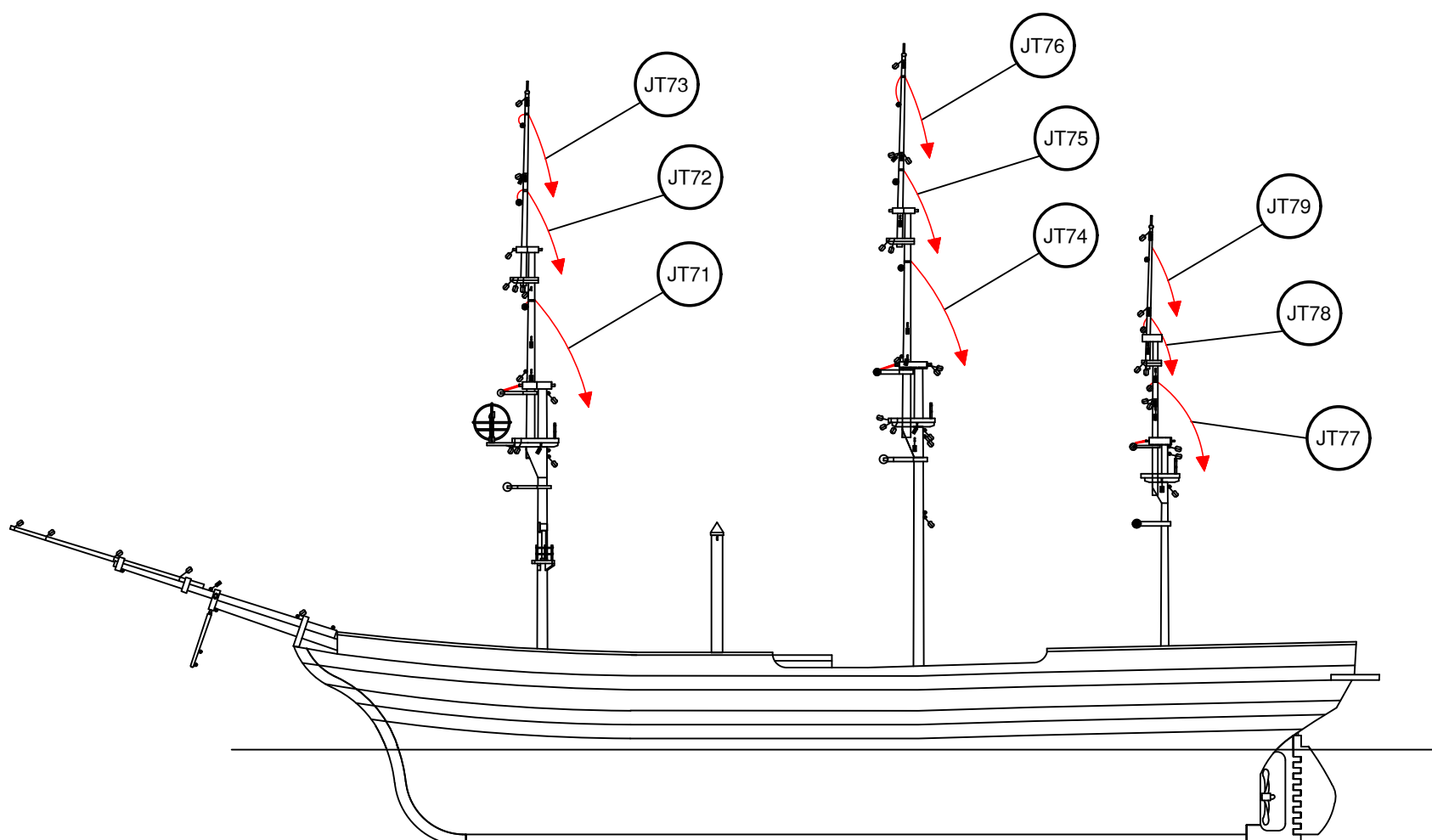

JT71	ø0,15x400	Hilo crudo / Raw thread / Fil brut / Rohes Baumwollfaden / Filo crudo	JT76	ø0,15x550	Hilo crudo / Raw thread / Fil brut / Rohes Baumwollfaden / Filo crudo
JT72	ø0,15x425	Hilo crudo / Raw thread / Fil brut / Rohes Baumwollfaden / Filo crudo	JT77	ø0,15x400	Hilo crudo / Raw thread / Fil brut / Rohes Baumwollfaden / Filo crudo
JT73	ø0,15x500	Hilo crudo / Raw thread / Fil brut / Rohes Baumwollfaden / Filo crudo	JT78	ø0,15x425	Hilo crudo / Raw thread / Fil brut / Rohes Baumwollfaden / Filo crudo
JT74	ø0,15x400	Hilo crudo / Raw thread / Fil brut / Rohes Baumwollfaden / Filo crudo	JT79	ø0,15x500	Hilo crudo / Raw thread / Fil brut / Rohes Baumwollfaden / Filo crudo
JT75	ø0,15x475	Hilo crudo / Raw thread / Fil brut / Rohes Baumwollfaden / Filo crudo			

Amerigo Vespucci

OCCRE

Aparejo de velas / Sail rig / Gréement
Segel takelage / Sartiame da vela

I

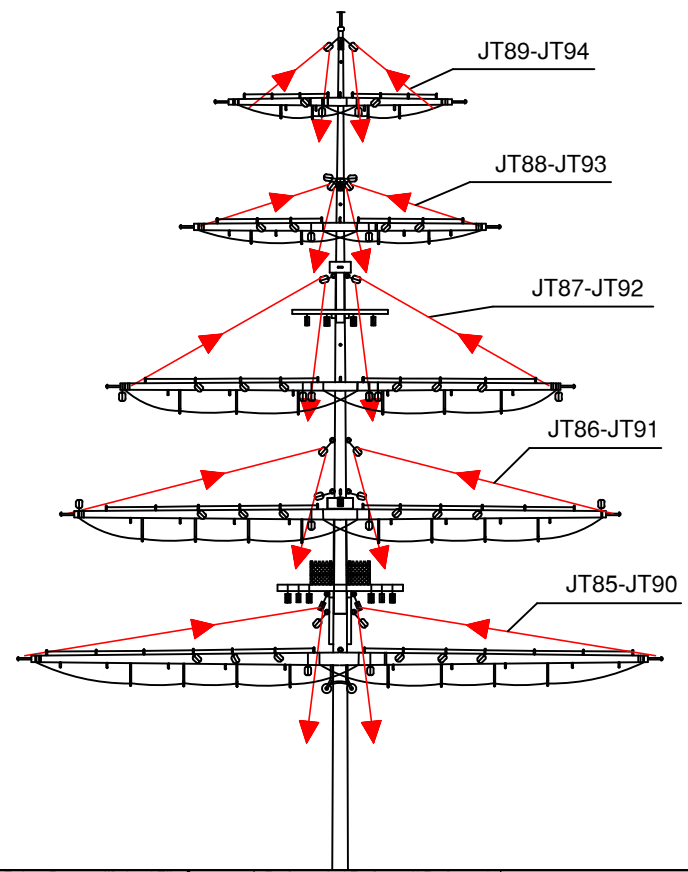
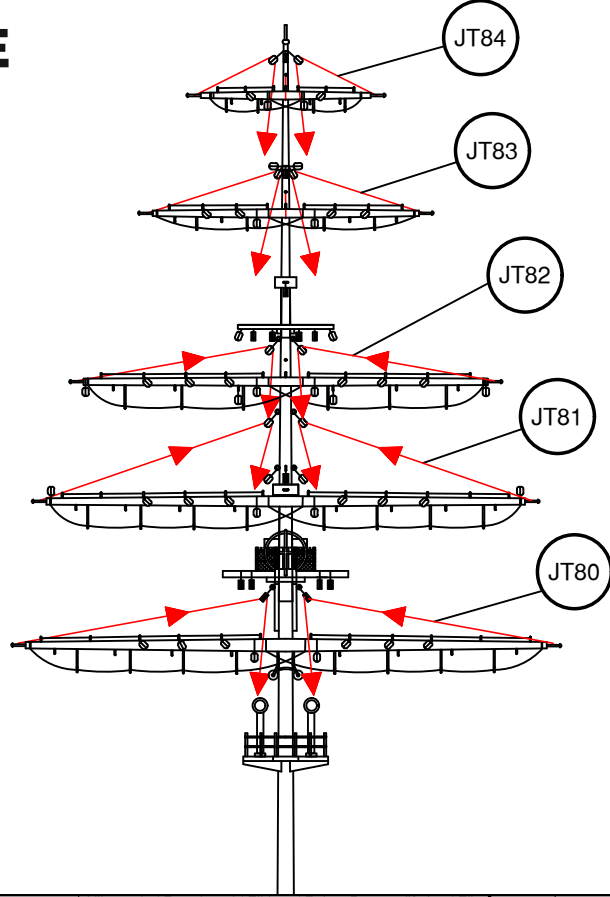

JT80	ø0,15x450	Hilo crudo / Raw thread / Fil brut / Rohes Baumwollfaden / Filo crudo	JT94	ø0,15x475	Hilo crudo / Raw thread / Fil brut / Rohes Baumwollfaden / Filo crudo	VT10	Preformado / Preformed / Préformé / Vorgeformt / Prefornato	Tela / Cloth / Étoffe / Stoff / Tela
JT81	ø0,15x550	Hilo crudo / Raw thread / Fil brut / Rohes Baumwollfaden / Filo crudo	JT95	ø0,15x1000	Hilo crudo / Raw thread / Fil brut / Rohes Baumwollfaden / Filo crudo	VT11	Preformado / Preformed / Préformé / Vorgeformt / Prefornato	Tela / Cloth / Étoffe / Stoff / Tela
JT82	ø0,15x600	Hilo crudo / Raw thread / Fil brut / Rohes Baumwollfaden / Filo crudo	JT96	ø0,15x400	Hilo crudo / Raw thread / Fil brut / Rohes Baumwollfaden / Filo crudo	VT12	Preformado / Preformed / Préformé / Vorgeformt / Prefornato	Tela / Cloth / Étoffe / Stoff / Tela
JT83	ø0,15x610	Hilo crudo / Raw thread / Fil brut / Rohes Baumwollfaden / Filo crudo	JT97	ø0,15x500	Hilo crudo / Raw thread / Fil brut / Rohes Baumwollfaden / Filo crudo	VT13	Preformado / Preformed / Préformé / Vorgeformt / Prefornato	Tela / Cloth / Étoffe / Stoff / Tela
JT84	ø0,15x615	Hilo crudo / Raw thread / Fil brut / Rohes Baumwollfaden / Filo crudo	JT98	ø0,15x550	Hilo crudo / Raw thread / Fil brut / Rohes Baumwollfaden / Filo crudo	VT14	Preformado / Preformed / Préformé / Vorgeformt / Prefornato	Tela / Cloth / Étoffe / Stoff / Tela
JT85	ø0,15x550	Hilo crudo / Raw thread / Fil brut / Rohes Baumwollfaden / Filo crudo	JT99	ø0,15x650	Hilo crudo / Raw thread / Fil brut / Rohes Baumwollfaden / Filo crudo	VT15	Preformado / Preformed / Préformé / Vorgeformt / Prefornato	Tela / Cloth / Étoffe / Stoff / Tela
JT86	ø0,15x650	Hilo crudo / Raw thread / Fil brut / Rohes Baumwollfaden / Filo crudo	JT100	ø0,15x475	Hilo crudo / Raw thread / Fil brut / Rohes Baumwollfaden / Filo crudo	VT16	Preformado / Preformed / Préformé / Vorgeformt / Prefornato	Tela / Cloth / Étoffe / Stoff / Tela
JT87	ø0,15x700	Hilo crudo / Raw thread / Fil brut / Rohes Baumwollfaden / Filo crudo	JT101	ø0,15x575	Hilo crudo / Raw thread / Fil brut / Rohes Baumwollfaden / Filo crudo	VT17	Preformado / Preformed / Préformé / Vorgeformt / Prefornato	Tela / Cloth / Étoffe / Stoff / Tela
JT88	ø0,15x710	Hilo crudo / Raw thread / Fil brut / Rohes Baumwollfaden / Filo crudo	JT102	ø0,15x625	Hilo crudo / Raw thread / Fil brut / Rohes Baumwollfaden / Filo crudo	VT18	Preformado / Preformed / Préformé / Vorgeformt / Prefornato	Tela / Cloth / Étoffe / Stoff / Tela
JT89	ø0,15x720	Hilo crudo / Raw thread / Fil brut / Rohes Baumwollfaden / Filo crudo	JT103	ø0,15x730	Hilo crudo / Raw thread / Fil brut / Rohes Baumwollfaden / Filo crudo	VT19	Preformado / Preformed / Préformé / Vorgeformt / Prefornato	Tela / Cloth / Étoffe / Stoff / Tela
JT90	ø0,15x300	Hilo crudo / Raw thread / Fil brut / Rohes Baumwollfaden / Filo crudo	JT104	ø0,15x300	Hilo crudo / Raw thread / Fil brut / Rohes Baumwollfaden / Filo crudo	VT20	Preformado / Preformed / Préformé / Vorgeformt / Prefornato	Tela / Cloth / Étoffe / Stoff / Tela
JT91	ø0,15x375	Hilo crudo / Raw thread / Fil brut / Rohes Baumwollfaden / Filo crudo	JT105	ø0,15x350	Hilo crudo / Raw thread / Fil brut / Rohes Baumwollfaden / Filo crudo	VT21	Preformado / Preformed / Préformé / Vorgeformt / Prefornato	Tela / Cloth / Étoffe / Stoff / Tela
JT92	ø0,15x400	Hilo crudo / Raw thread / Fil brut / Rohes Baumwollfaden / Filo crudo	JT106	ø0,15x400	Hilo crudo / Raw thread / Fil brut / Rohes Baumwollfaden / Filo crudo	VT22	Preformado / Preformed / Préformé / Vorgeformt / Prefornato	Tela / Cloth / Étoffe / Stoff / Tela
JT93	ø0,15x425	Hilo crudo / Raw thread / Fil brut / Rohes Baumwollfaden / Filo crudo	JT107	ø0,15x450	Hilo crudo / Raw thread / Fil brut / Rohes Baumwollfaden / Filo crudo	VT23	Preformado / Preformed / Préformé / Vorgeformt / Prefornato	Tela / Cloth / Étoffe / Stoff / Tela

J

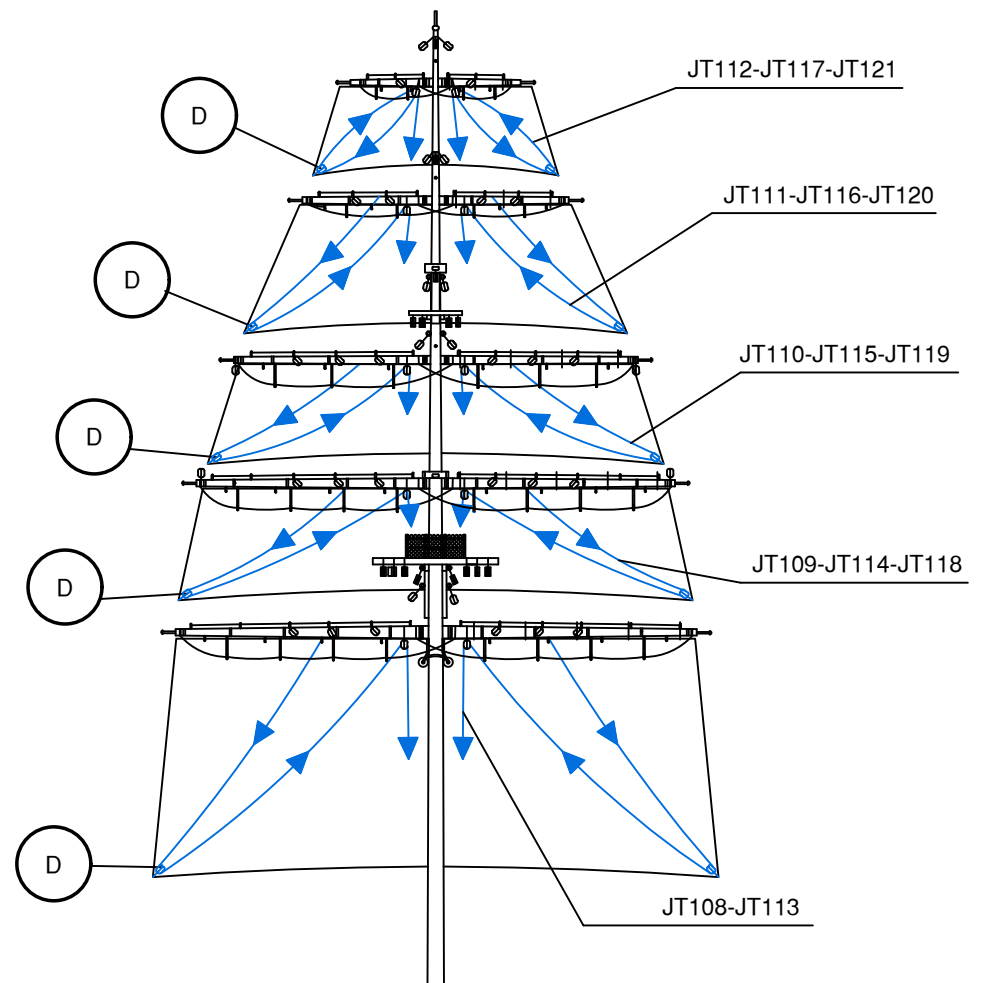
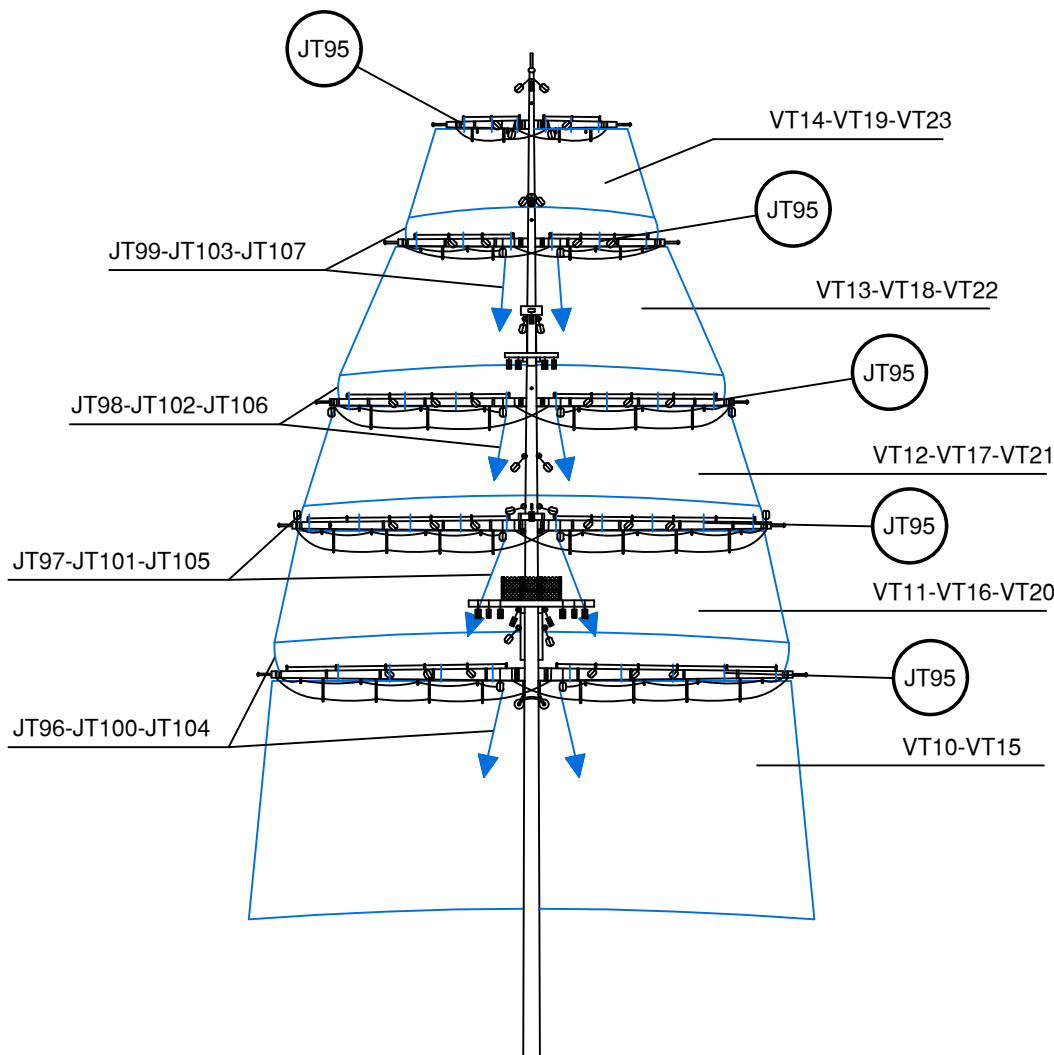

JT108	ø0,15x480	Hilo crudo / Raw thread / Fil brut / Rohes Baumwollfaden / Filo crudo	JT116	ø0,15x750	Hilo crudo / Raw thread / Fil brut / Rohes Baumwollfaden / Filo crudo
JT109	ø0,15x475	Hilo crudo / Raw thread / Fil brut / Rohes Baumwollfaden / Filo crudo	JT117	ø0,15x800	Hilo crudo / Raw thread / Fil brut / Rohes Baumwollfaden / Filo crudo
JT110	ø0,15x575	Hilo crudo / Raw thread / Fil brut / Rohes Baumwollfaden / Filo crudo	JT118	ø0,15x400	Hilo crudo / Raw thread / Fil brut / Rohes Baumwollfaden / Filo crudo
JT111	ø0,15x675	Hilo crudo / Raw thread / Fil brut / Rohes Baumwollfaden / Filo crudo	JT119	ø0,15x450	Hilo crudo / Raw thread / Fil brut / Rohes Baumwollfaden / Filo crudo
JT112	ø0,15x725	Hilo crudo / Raw thread / Fil brut / Rohes Baumwollfaden / Filo crudo	JT120	ø0,15x500	Hilo crudo / Raw thread / Fil brut / Rohes Baumwollfaden / Filo crudo
JT113	ø0,15x480	Hilo crudo / Raw thread / Fil brut / Rohes Baumwollfaden / Filo crudo	JT121	ø0,15x550	Hilo crudo / Raw thread / Fil brut / Rohes Baumwollfaden / Filo crudo
JT114	ø0,15x500	Hilo crudo / Raw thread / Fil brut / Rohes Baumwollfaden / Filo crudo	D	4	Madera / Wood / Bois / Holz / Legno
JT115	ø0,15x625	Hilo crudo / Raw thread / Fil brut / Rohes Baumwollfaden / Filo crudo			

Amerigo Vespucci

OCCRE

Aparejo de velas / Sail rig / Gréement
Segel takelage / Sartiame da vela

(K)

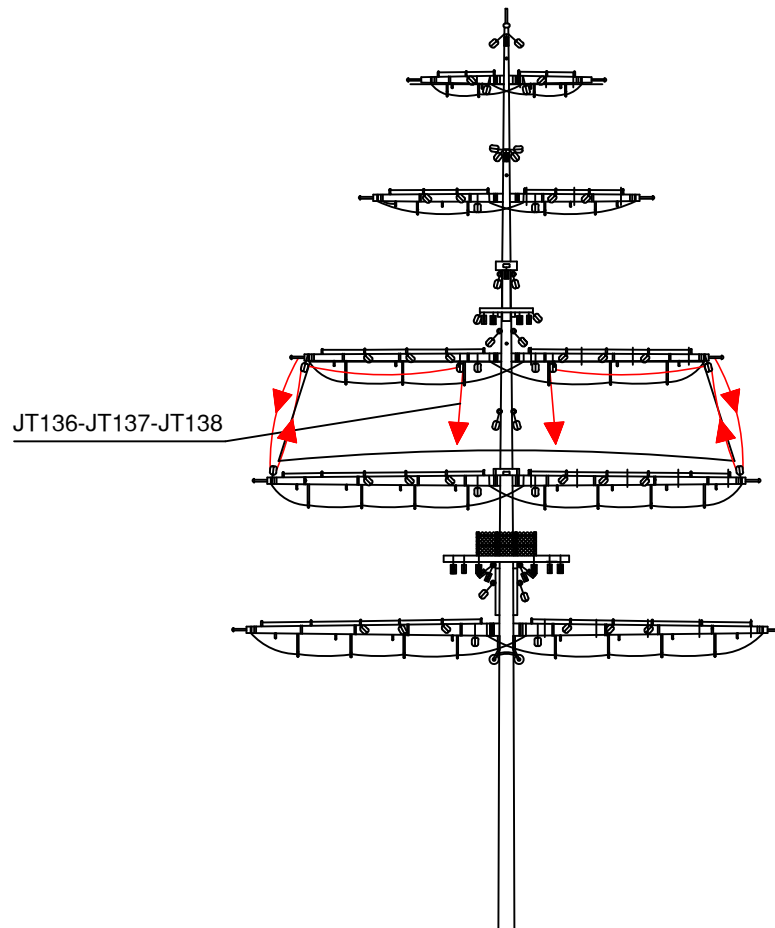
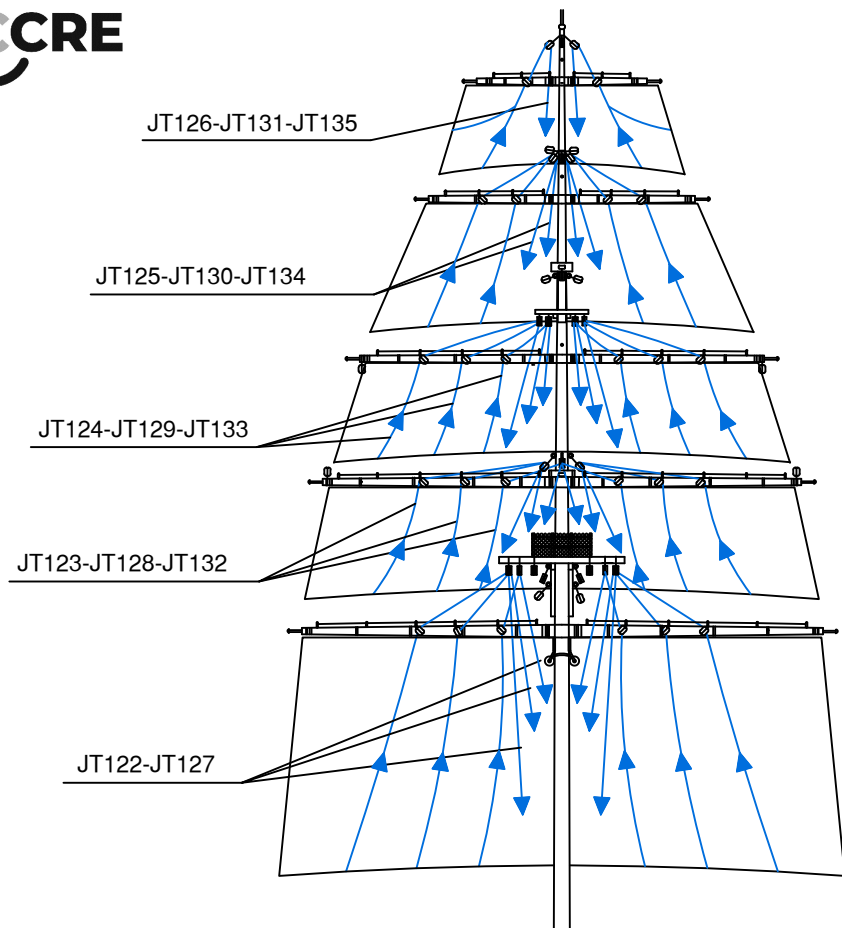

JT122	∅0,15x375	Hilo crudo / Raw thread / Fil brut / Rohes Baumwollfaden / Filo crudo	JT131	∅0,15x625	Hilo crudo / Raw thread / Fil brut / Rohes Baumwollfaden / Filo crudo
JT123	∅0,15x425	Hilo crudo / Raw thread / Fil brut / Rohes Baumwollfaden / Filo crudo	JT132	∅0,15x350	Hilo crudo / Raw thread / Fil brut / Rohes Baumwollfaden / Filo crudo
JT124	∅0,15x500	Hilo crudo / Raw thread / Fil brut / Rohes Baumwollfaden / Filo crudo	JT133	∅0,15x380	Hilo crudo / Raw thread / Fil brut / Rohes Baumwollfaden / Filo crudo
JT125	∅0,15x500	Hilo crudo / Raw thread / Fil brut / Rohes Baumwollfaden / Filo crudo	JT134	∅0,15x425	Hilo crudo / Raw thread / Fil brut / Rohes Baumwollfaden / Filo crudo
JT126	∅0,15x575	Hilo crudo / Raw thread / Fil brut / Rohes Baumwollfaden / Filo crudo	JT135	∅0,15x500	Hilo crudo / Raw thread / Fil brut / Rohes Baumwollfaden / Filo crudo
JT127	∅0,15x425	Hilo crudo / Raw thread / Fil brut / Rohes Baumwollfaden / Filo crudo	JT136	∅0,15x500	Hilo crudo / Raw thread / Fil brut / Rohes Baumwollfaden / Filo crudo
JT128	∅0,15x475	Hilo crudo / Raw thread / Fil brut / Rohes Baumwollfaden / Filo crudo	JT137	∅0,15x600	Hilo crudo / Raw thread / Fil brut / Rohes Baumwollfaden / Filo crudo
JT129	∅0,15x550	Hilo crudo / Raw thread / Fil brut / Rohes Baumwollfaden / Filo crudo	JT138	∅0,15x325	Hilo crudo / Raw thread / Fil brut / Rohes Baumwollfaden / Filo crudo
JT130	∅0,15x565	Hilo crudo / Raw thread / Fil brut / Rohes Baumwollfaden / Filo crudo			

(L)

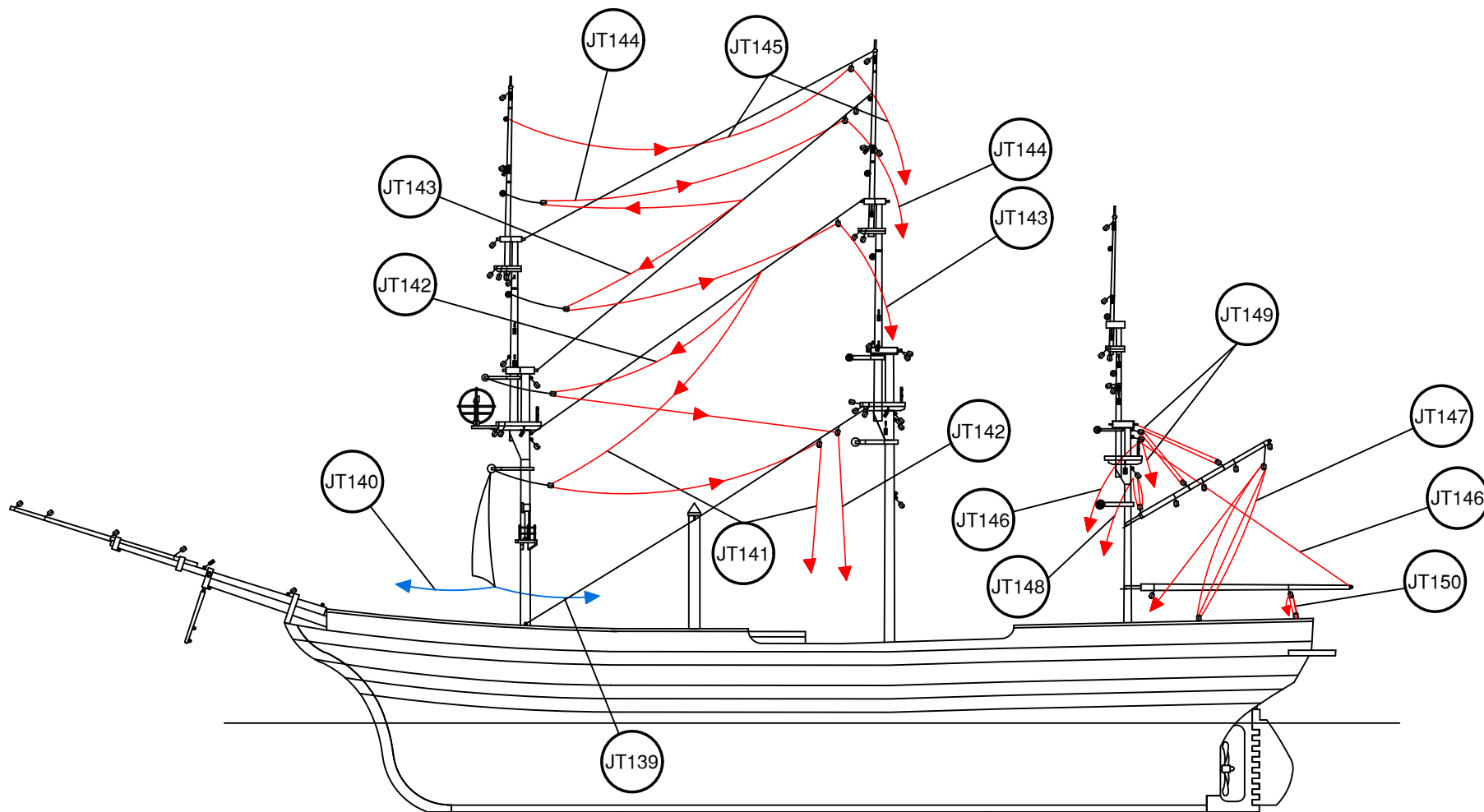

JT139	∅0,15x400	Hilo crudo / Raw thread / Fil brut / Rohes Baumwollfaden / Filo crudo	JT145	∅0,15x900	Hilo crudo / Raw thread / Fil brut / Rohes Baumwollfaden / Filo crudo
JT140	∅0,15x450	Hilo crudo / Raw thread / Fil brut / Rohes Baumwollfaden / Filo crudo	JT146	∅0,15x450	Hilo crudo / Raw thread / Fil brut / Rohes Baumwollfaden / Filo crudo
JT141	∅0,15x700	Hilo crudo / Raw thread / Fil brut / Rohes Baumwollfaden / Filo crudo	JT147	∅0,15x700	Hilo crudo / Raw thread / Fil brut / Rohes Baumwollfaden / Filo crudo
JT142	∅0,15x775	Hilo crudo / Raw thread / Fil brut / Rohes Baumwollfaden / Filo crudo	JT148	∅0,15x350	Hilo crudo / Raw thread / Fil brut / Rohes Baumwollfaden / Filo crudo
JT143	∅0,15x800	Hilo crudo / Raw thread / Fil brut / Rohes Baumwollfaden / Filo crudo	JT149	∅0,15x400	Hilo crudo / Raw thread / Fil brut / Rohes Baumwollfaden / Filo crudo
JT144	∅0,15x850	Hilo crudo / Raw thread / Fil brut / Rohes Baumwollfaden / Filo crudo	JT150	∅0,15x250	Hilo crudo / Raw thread / Fil brut / Rohes Baumwollfaden / Filo crudo

Amerigo Vespucci

OCCRE

Aparejo de velas / Sail rig / Gréement
Segel takelage / Sartiame da vela

M

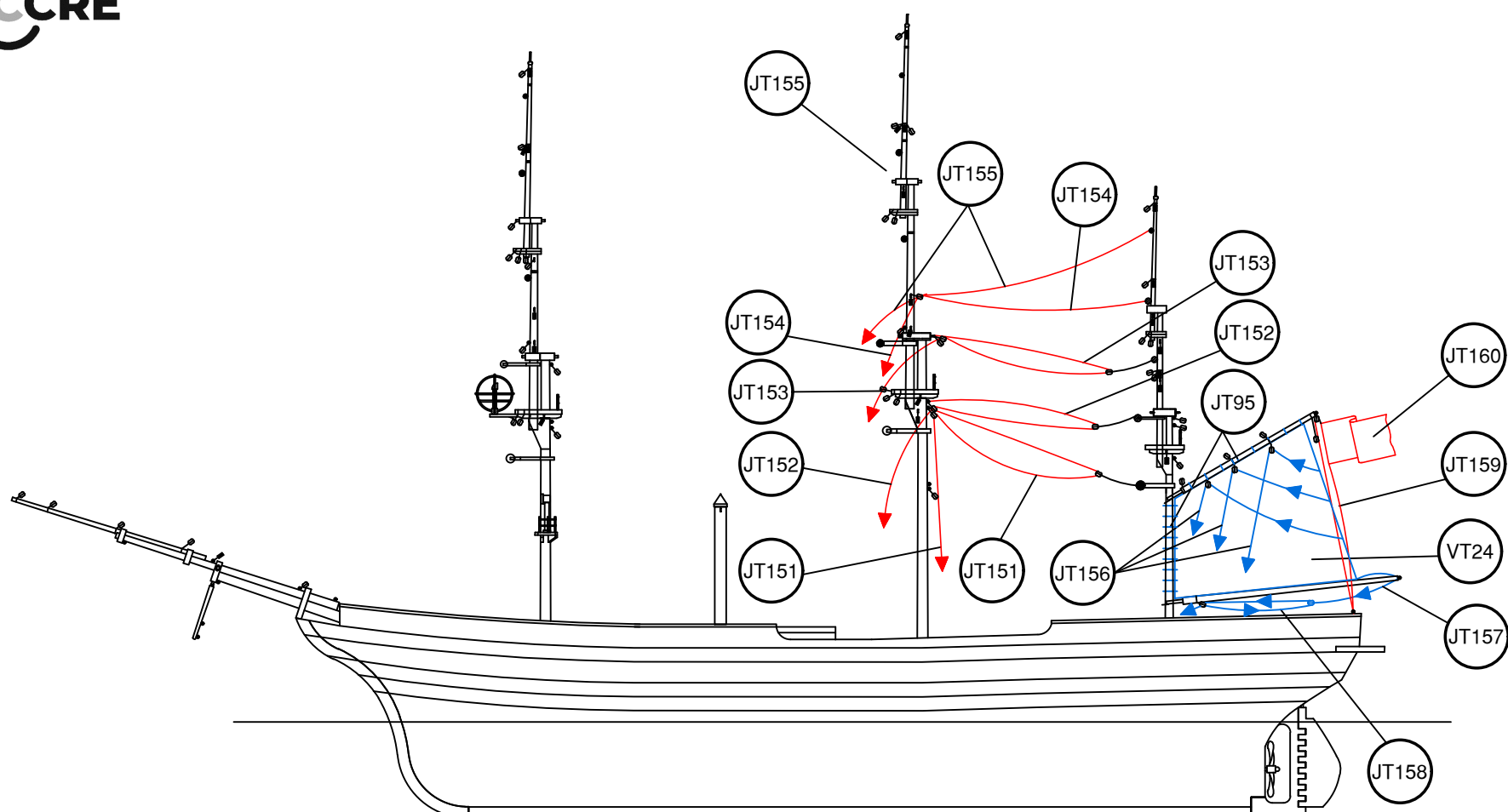

JT151	∅0,15x500	Hilo crudo / Raw thread / Fil brut / Rohes Baumwollfaden / Filo crudo	JT157	∅0,15x150	Hilo crudo / Raw thread / Fil brut / Rohes Baumwollfaden / Filo crudo
JT152	∅0,15x500	Hilo crudo / Raw thread / Fil brut / Rohes Baumwollfaden / Filo crudo	JT158	∅0,15x250	Hilo crudo / Raw thread / Fil brut / Rohes Baumwollfaden / Filo crudo
JT153	∅0,15x600	Hilo crudo / Raw thread / Fil brut / Rohes Baumwollfaden / Filo crudo	JT159	∅0,15x650	Hilo crudo / Raw thread / Fil brut / Rohes Baumwollfaden / Filo crudo
JT154	∅0,15x600	Hilo crudo / Raw thread / Fil brut / Rohes Baumwollfaden / Filo crudo	JT160	Preformado	Hilo crudo / Raw thread / Fil brut / Rohes Baumwollfaden / Filo crudo
JT155	∅0,15x600	Hilo crudo / Raw thread / Fil brut / Rohes Baumwollfaden / Filo crudo	VT24	Preformado / Preformed/ Préformé / Vorgeformt / Preformato	Tela / Cloth / Étoffe / Stoff / Tela
JT156	∅0,15x350	Hilo crudo / Raw thread / Fil brut / Rohes Baumwollfaden / Filo crudo			

N

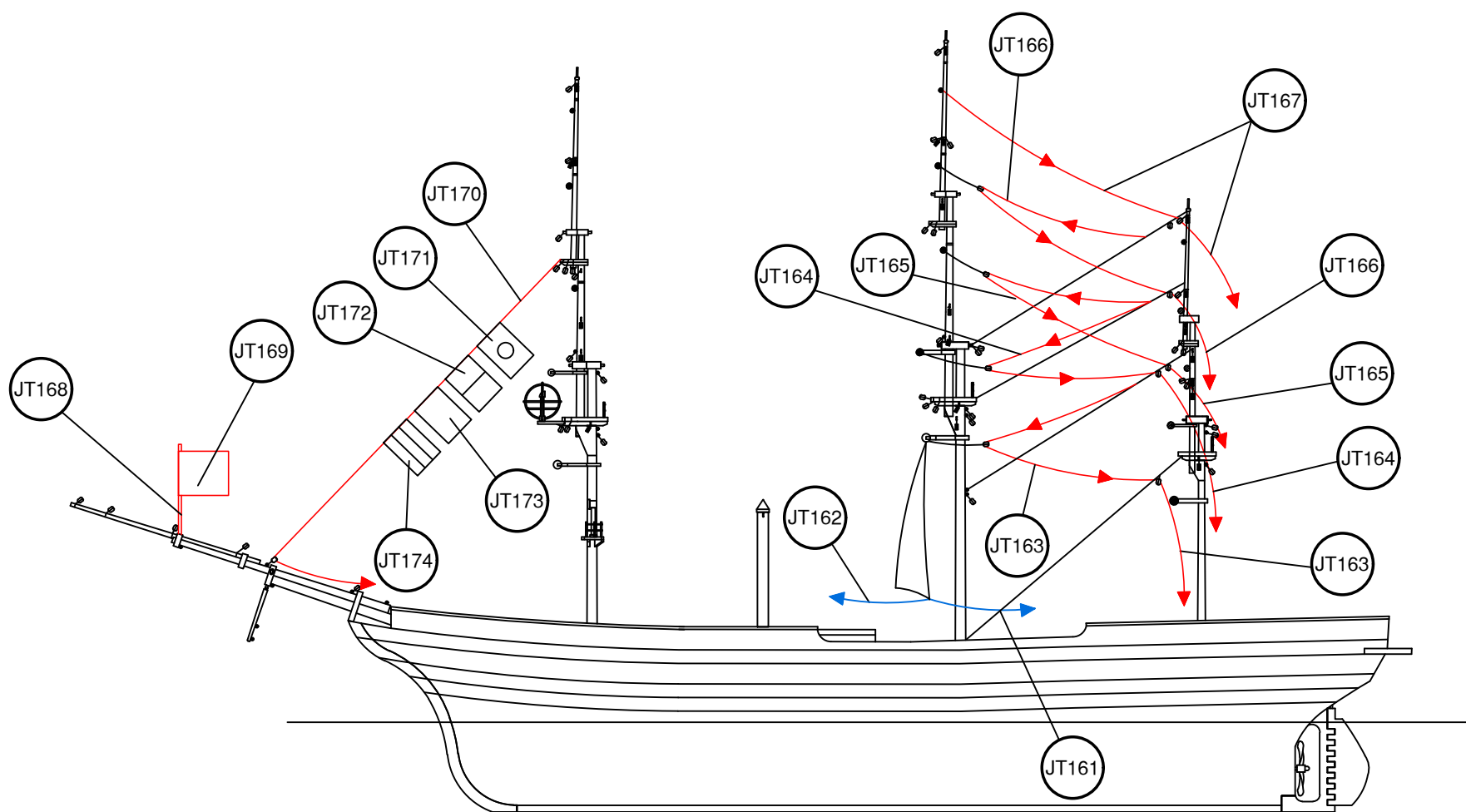

JT161	∅0,15x300	Hilo crudo / Raw thread / Fil brut / Rohes Baumwollfaden / Filo crudo	JT168	∅01,5x45	Latón / Brass / Latón / Messing / Ottone
JT162	∅0,15x400	Hilo crudo / Raw thread / Fil brut / Rohes Baumwollfaden / Filo crudo	JT169	Preformado / Preformed/ Préformé / Vorgeformt / Preformato	Tela / Cloth / Étoffe / Stoff / Tela
JT163	∅0,15x600	Hilo crudo / Raw thread / Fil brut / Rohes Baumwollfaden / Filo crudo	JT170	∅0,15x600	Hilo crudo / Raw thread / Fil brut / Rohes Baumwollfaden / Filo crudo
JT164	∅0,15x600	Hilo crudo / Raw thread / Fil brut / Rohes Baumwollfaden / Filo crudo	JT171	Preformado / Preformed/ Préformé / Vorgeformt / Preformato	Tela / Cloth / Étoffe / Stoff / Tela
JT165	∅0,15x660	Hilo crudo / Raw thread / Fil brut / Rohes Baumwollfaden / Filo crudo	JT172	Preformado / Preformed/ Préformé / Vorgeformt / Preformato	Tela / Cloth / Étoffe / Stoff / Tela
JT166	∅0,15x700	Hilo crudo / Raw thread / Fil brut / Rohes Baumwollfaden / Filo crudo	JT173	Preformado / Preformed/ Préformé / Vorgeformt / Preformato	Tela / Cloth / Étoffe / Stoff / Tela
JT167	∅0,15x700	Hilo crudo / Raw thread / Fil brut / Rohes Baumwollfaden / Filo crudo	JT174	Preformado / Preformed/ Préformé / Vorgeformt / Preformato	Tela / Cloth / Étoffe / Stoff / Tela

